

tre gem

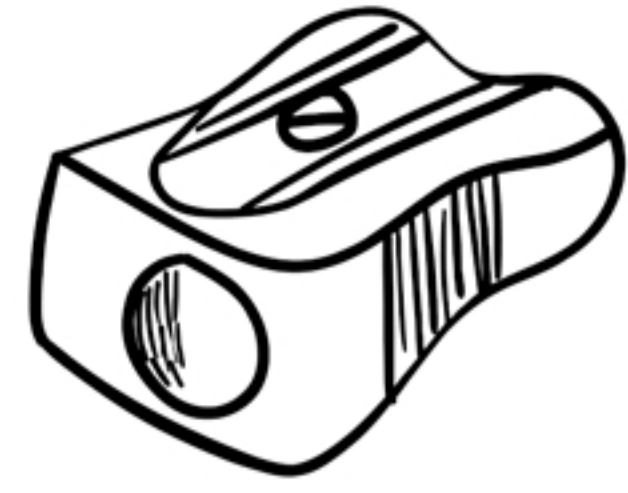

en ryggsäck

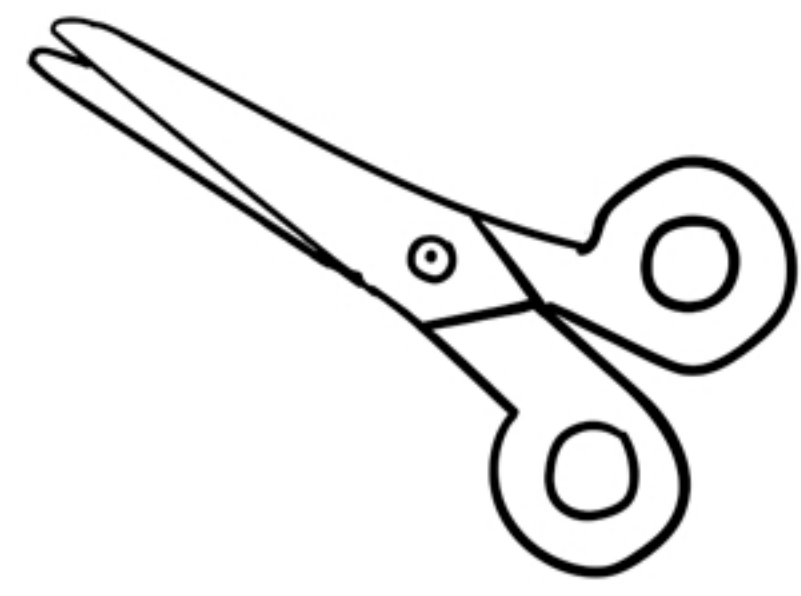

en fotboll

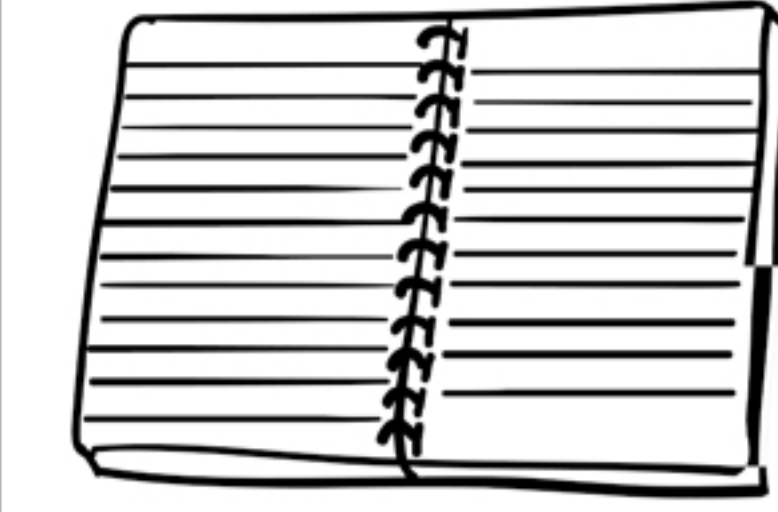
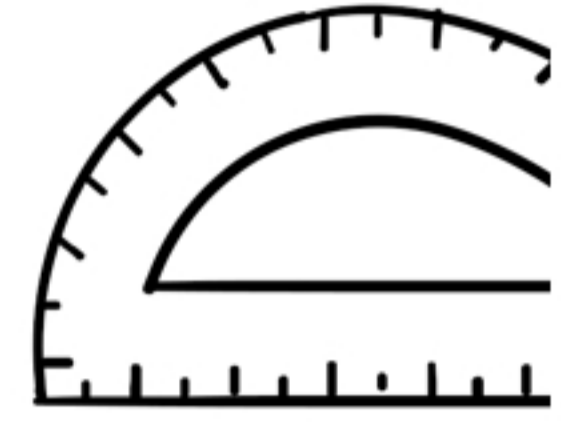

ett skrivhäfte

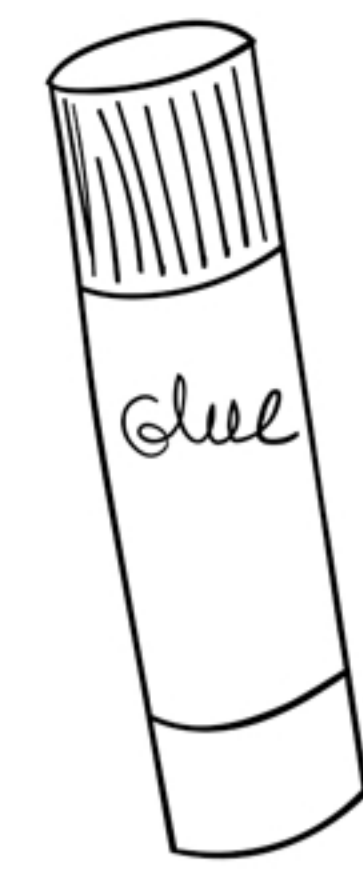

ett limstift

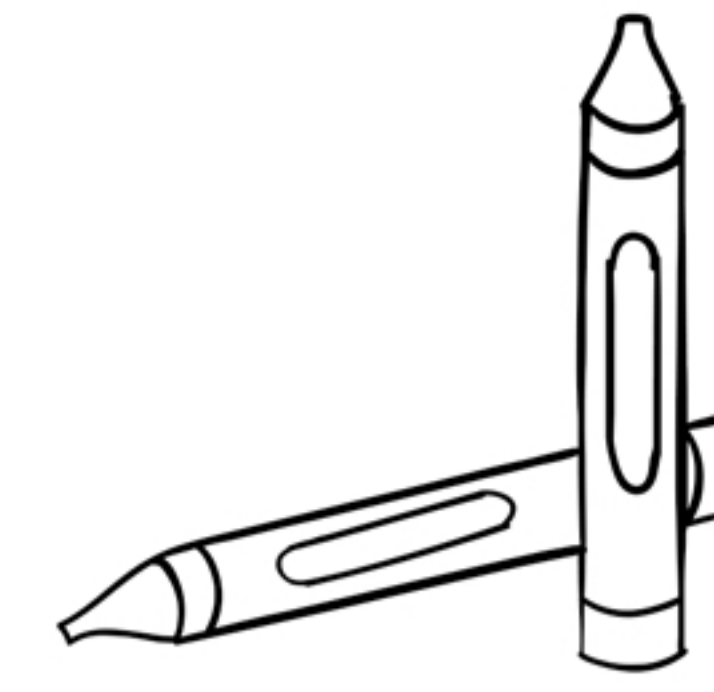

två kitor

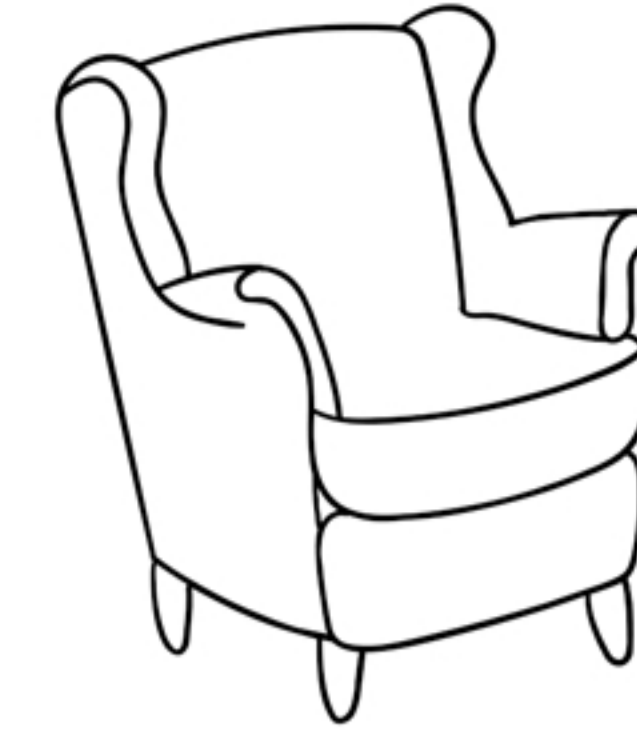

en fåtölj

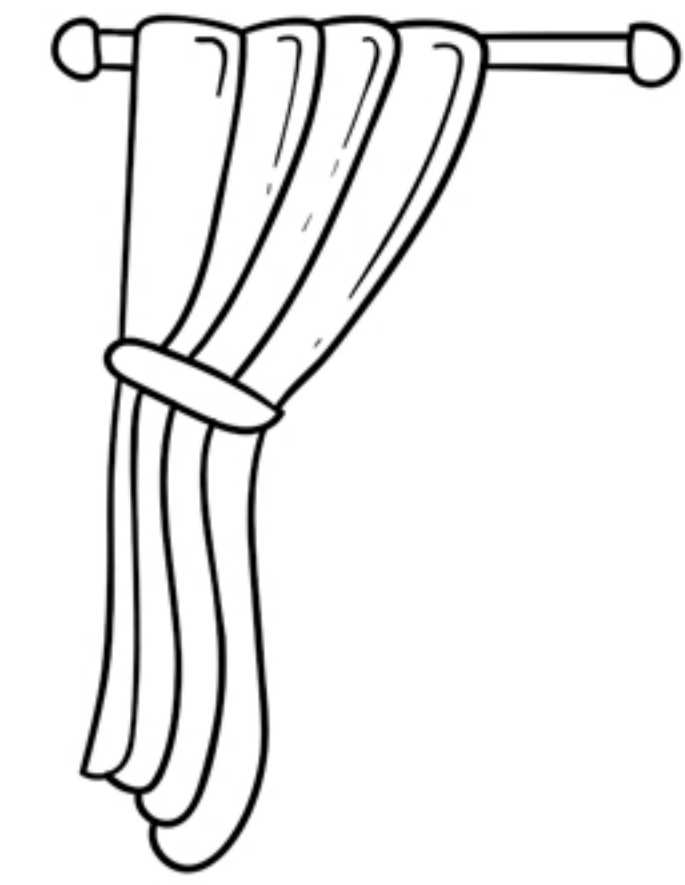

en gardin

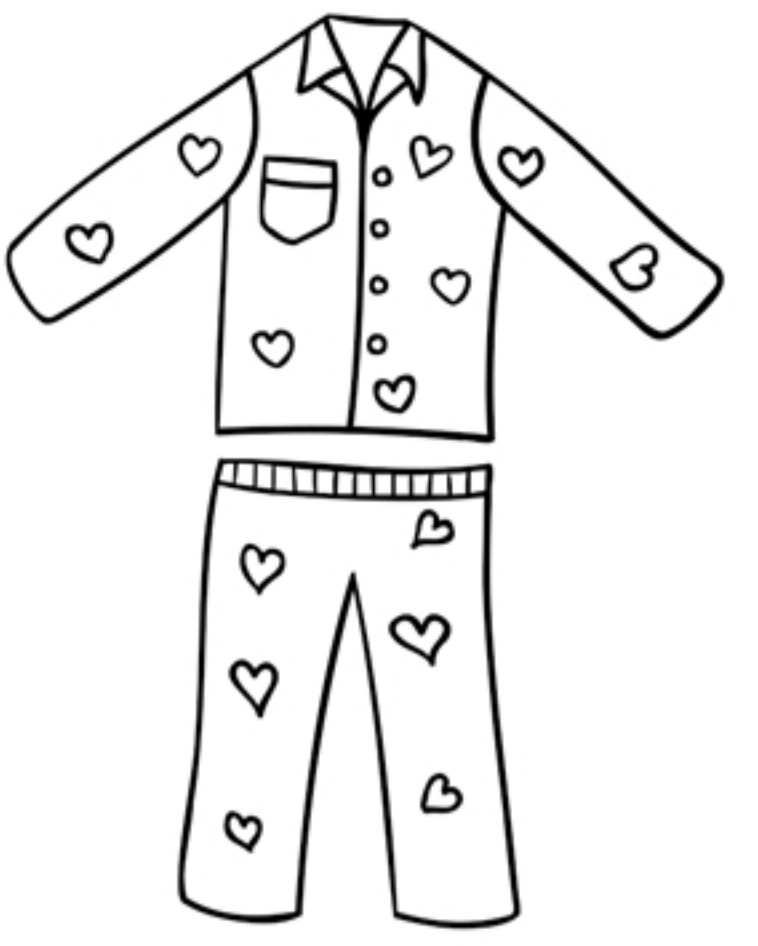

en pyjamas

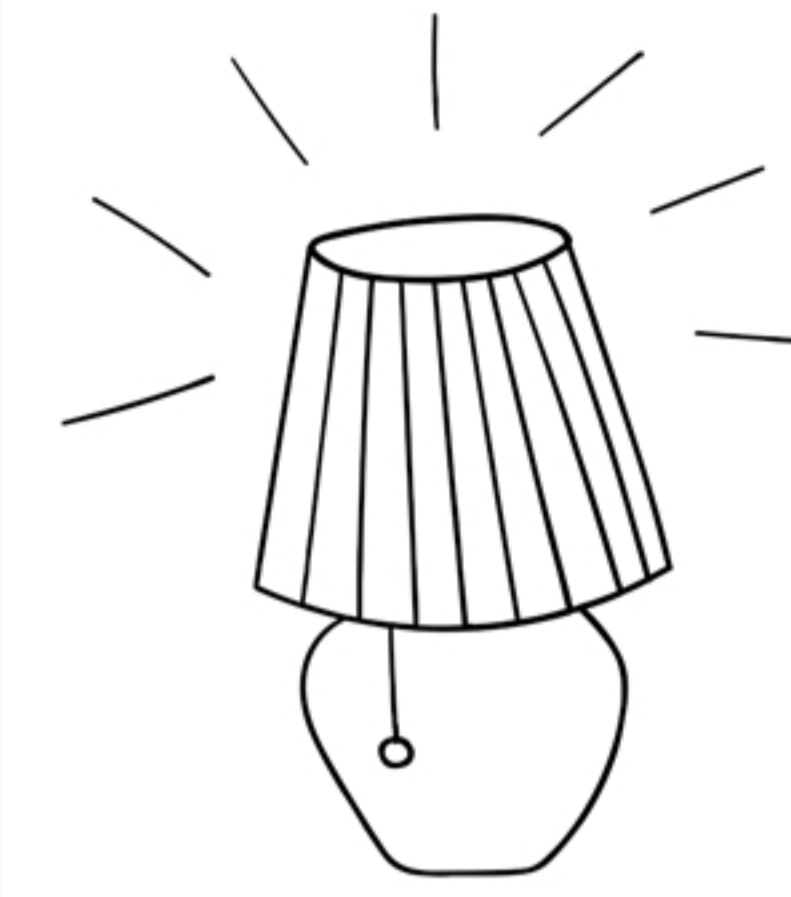
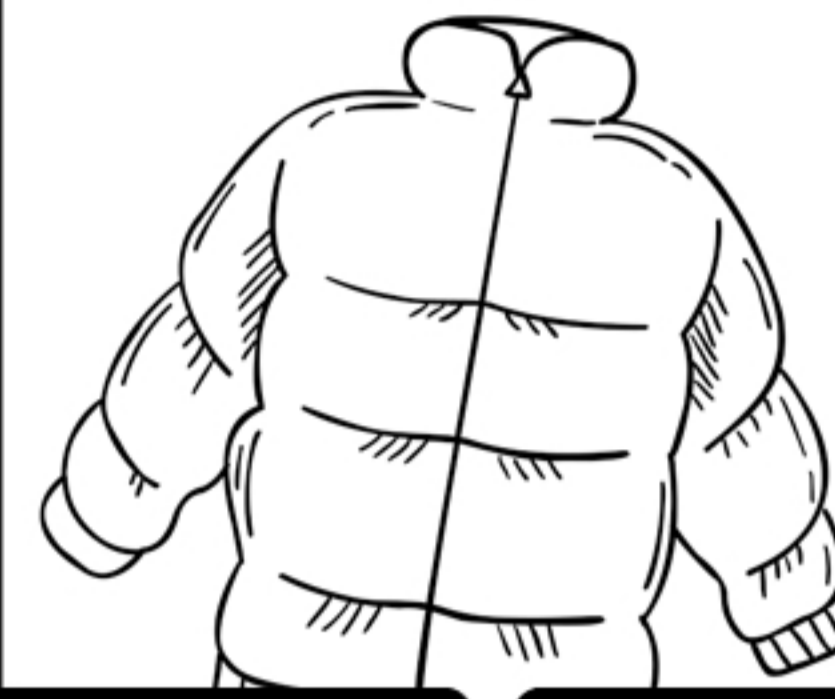

en sänglampa



en kudde



en sänghylla

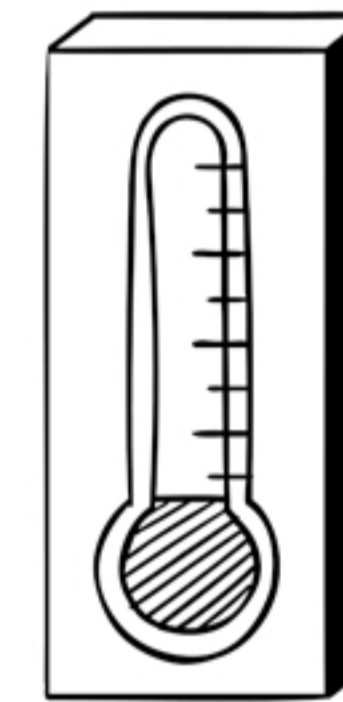

en termometer

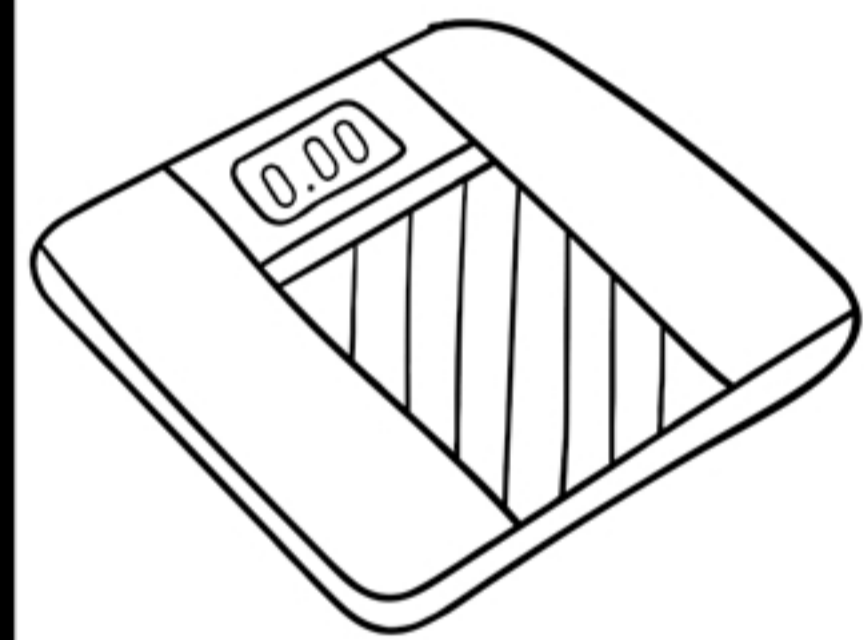

en våg

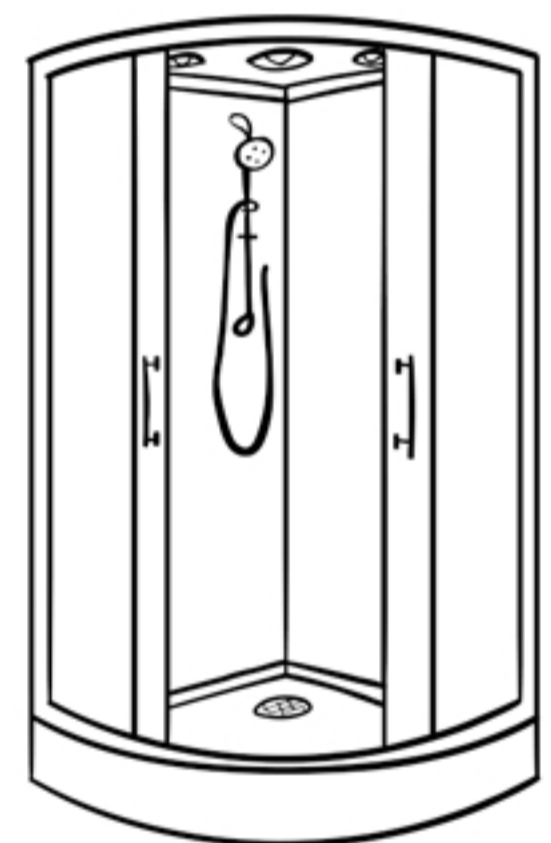

en dusch



en tandborste



en kam



en tandkrämstüb



en spegel

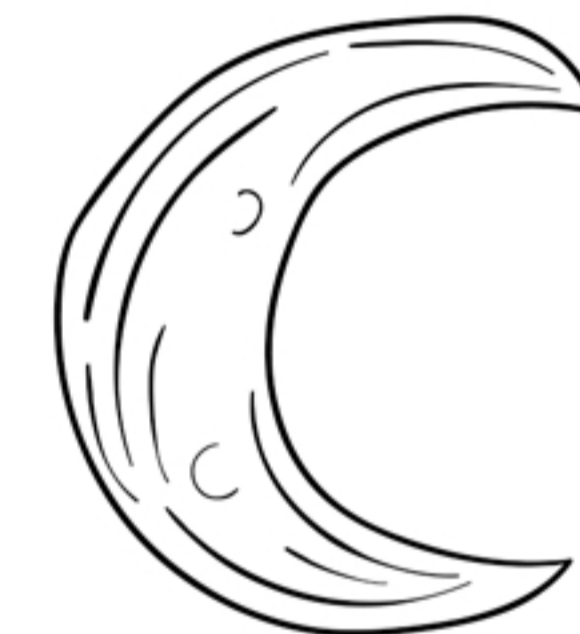

en måne



några stjärnor



en nact

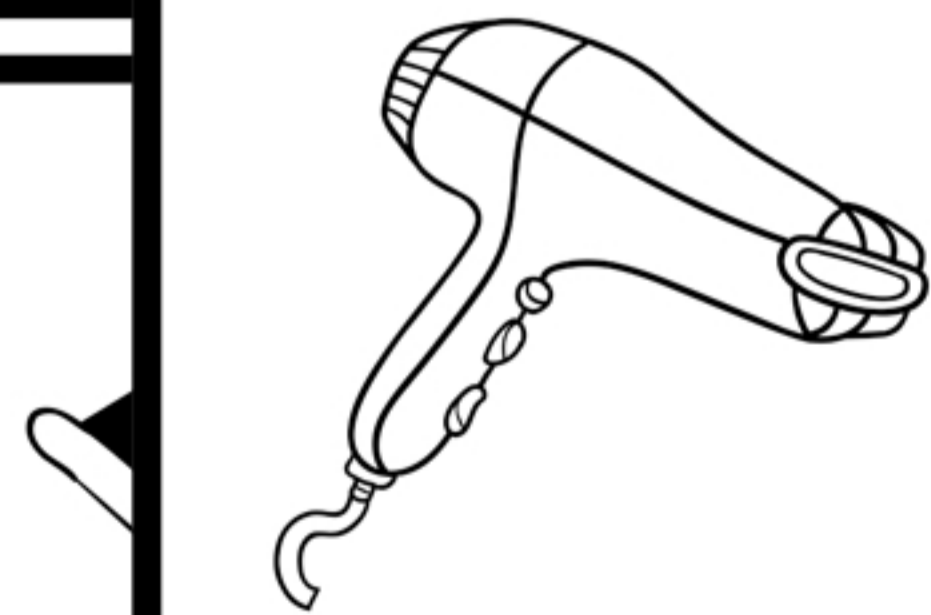

en hårtork



toalettpapper

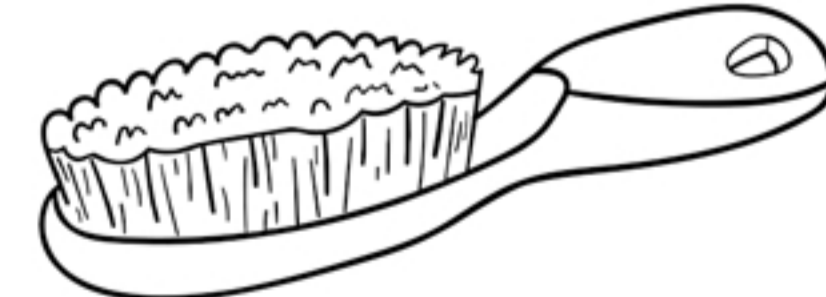

en hårborste

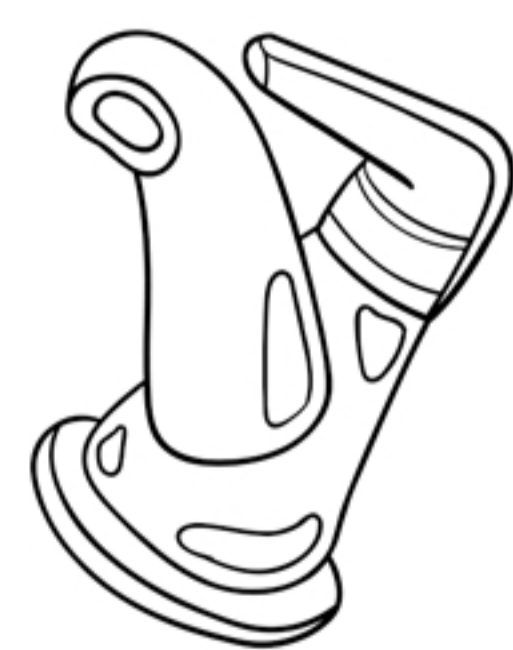

en vattenkran



ett par tofflor



en nyckel



en uggle

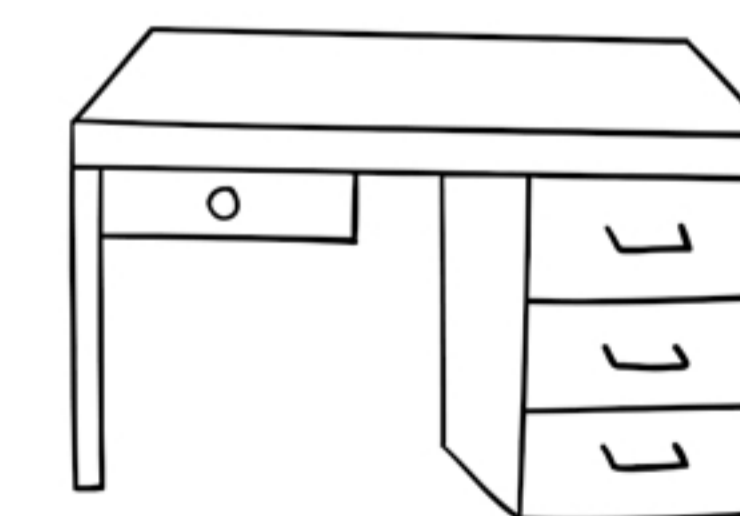

ett skrivbord

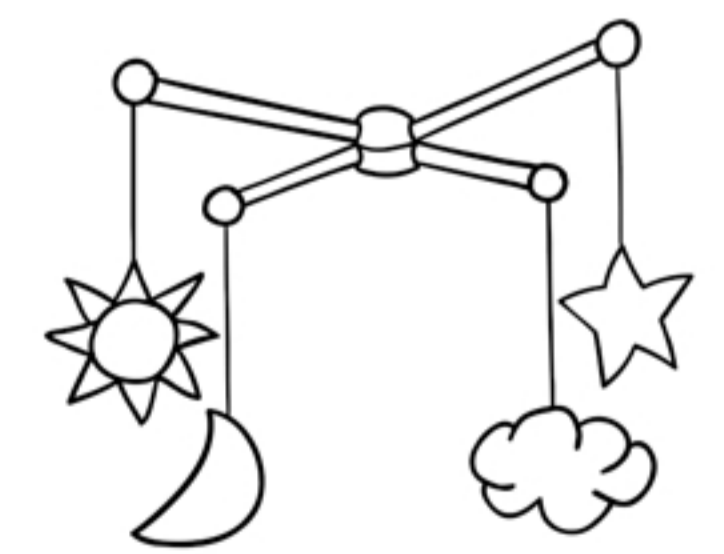

en mobil



en björ

en solstol

en strandväska

en glasstrut

en badb

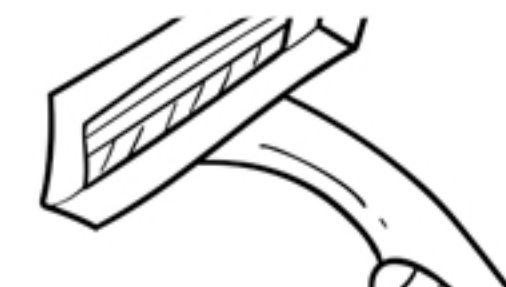
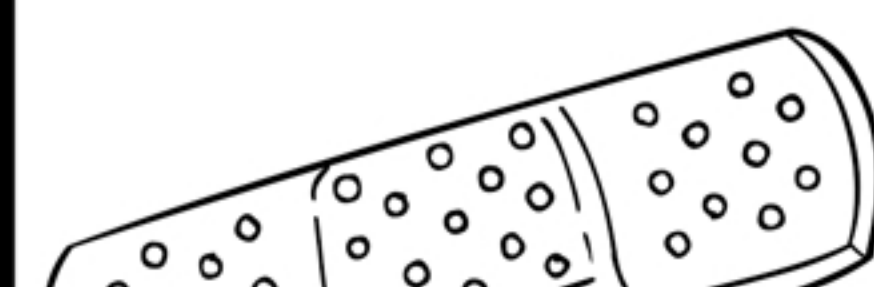

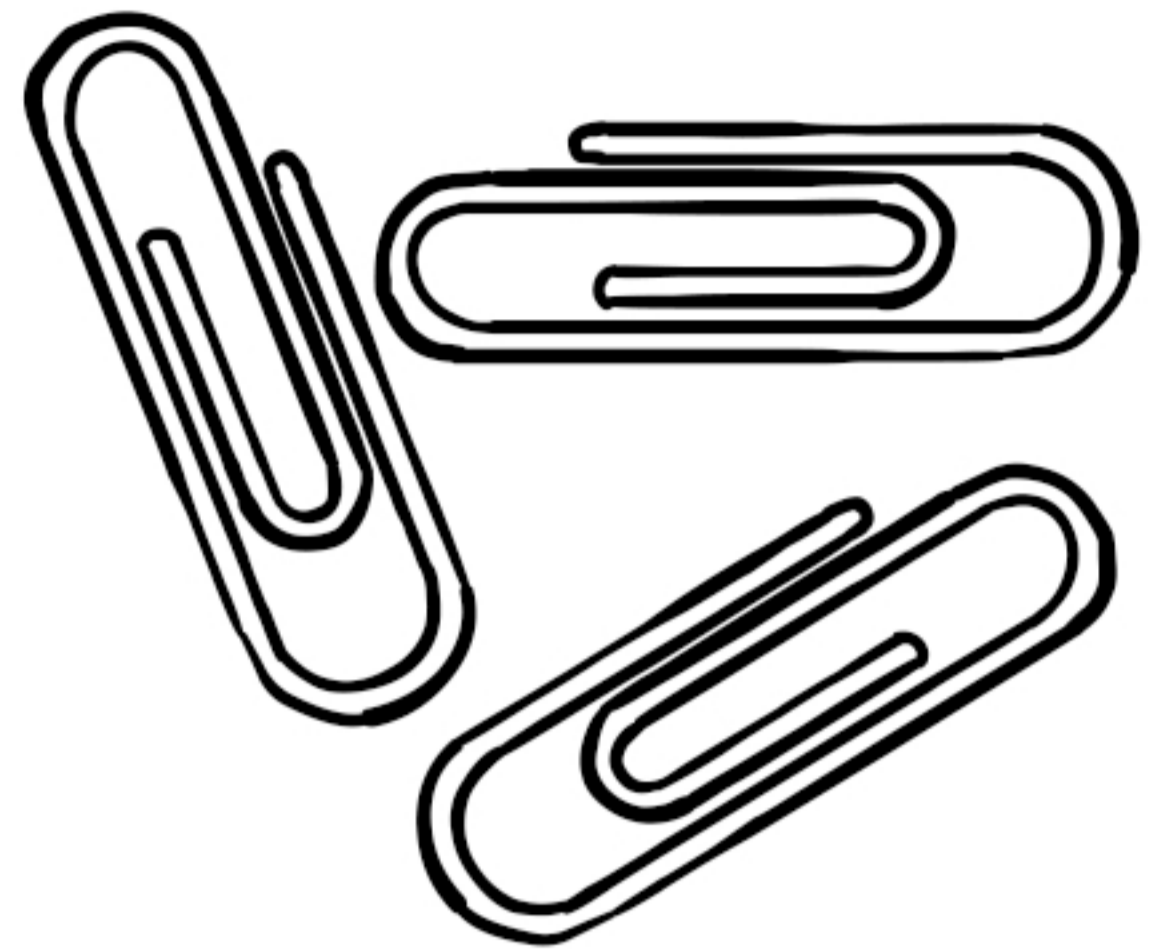

*tre gem*

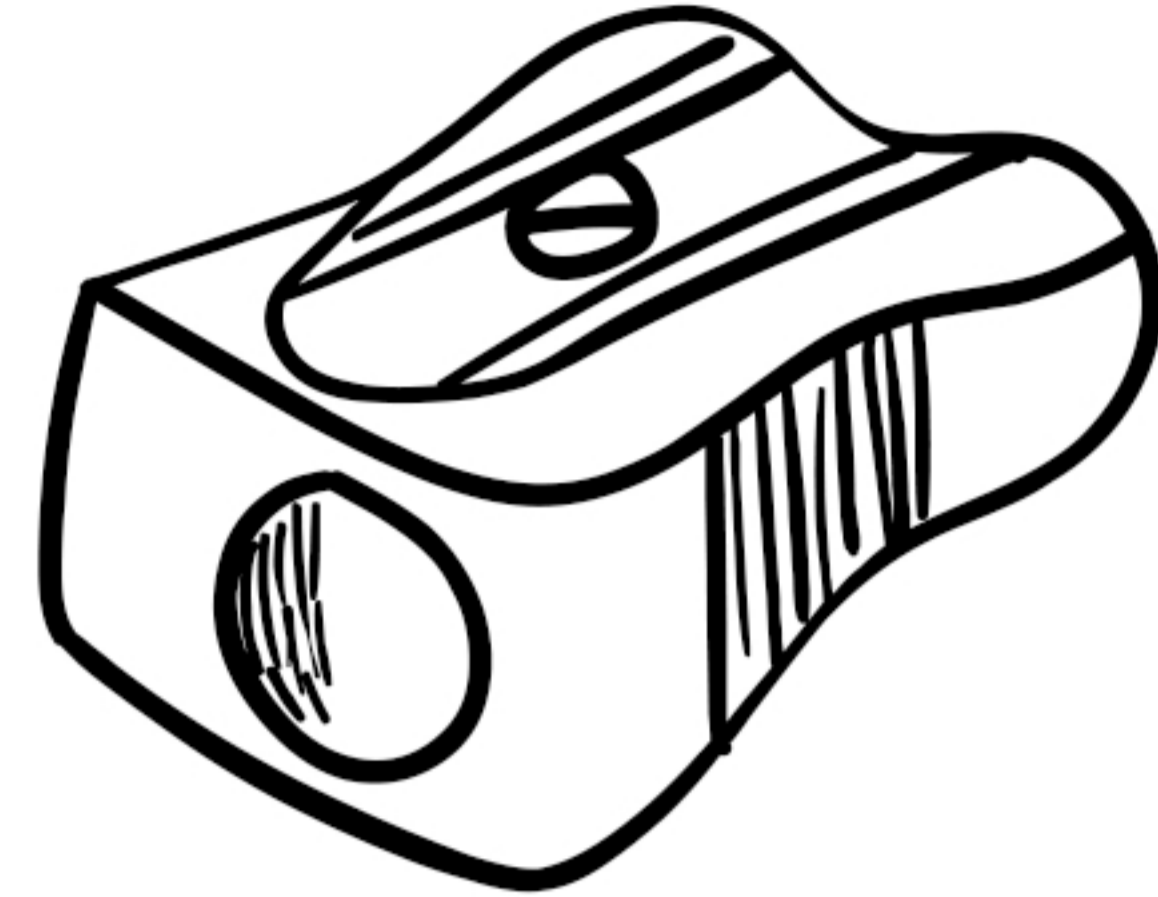

*en pennvässare*

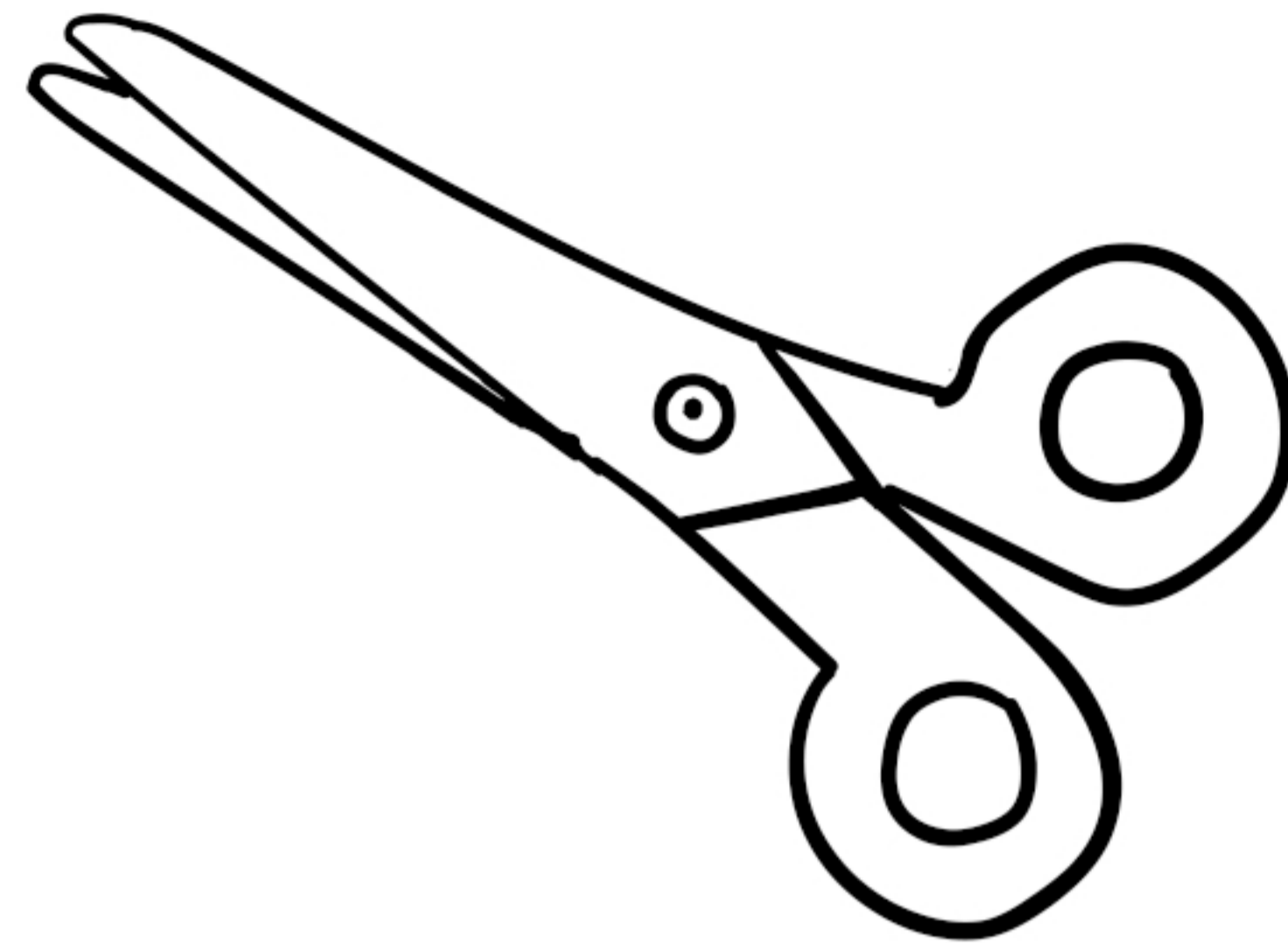

*en sax*



*en sko*

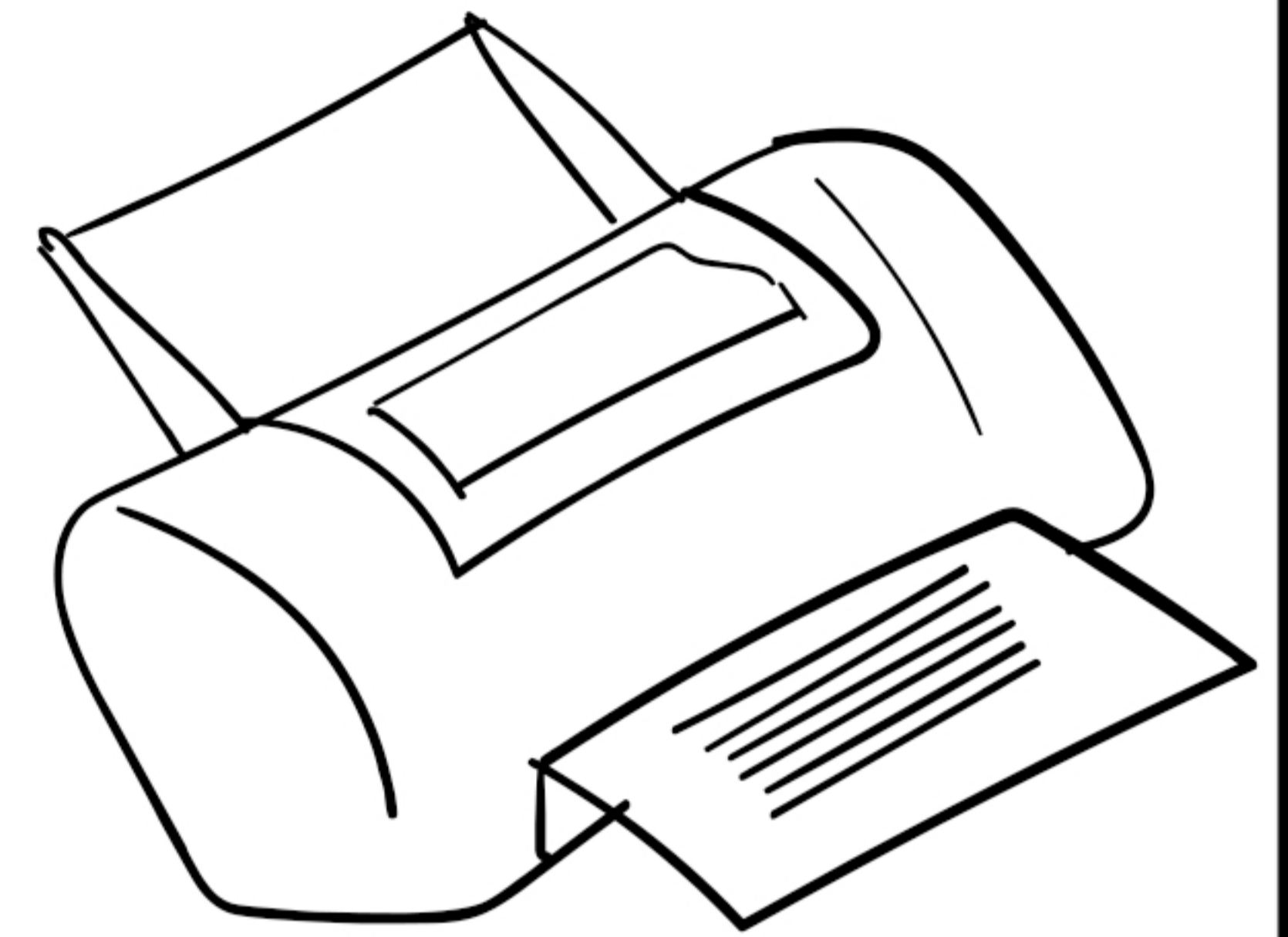

*en skrivare*

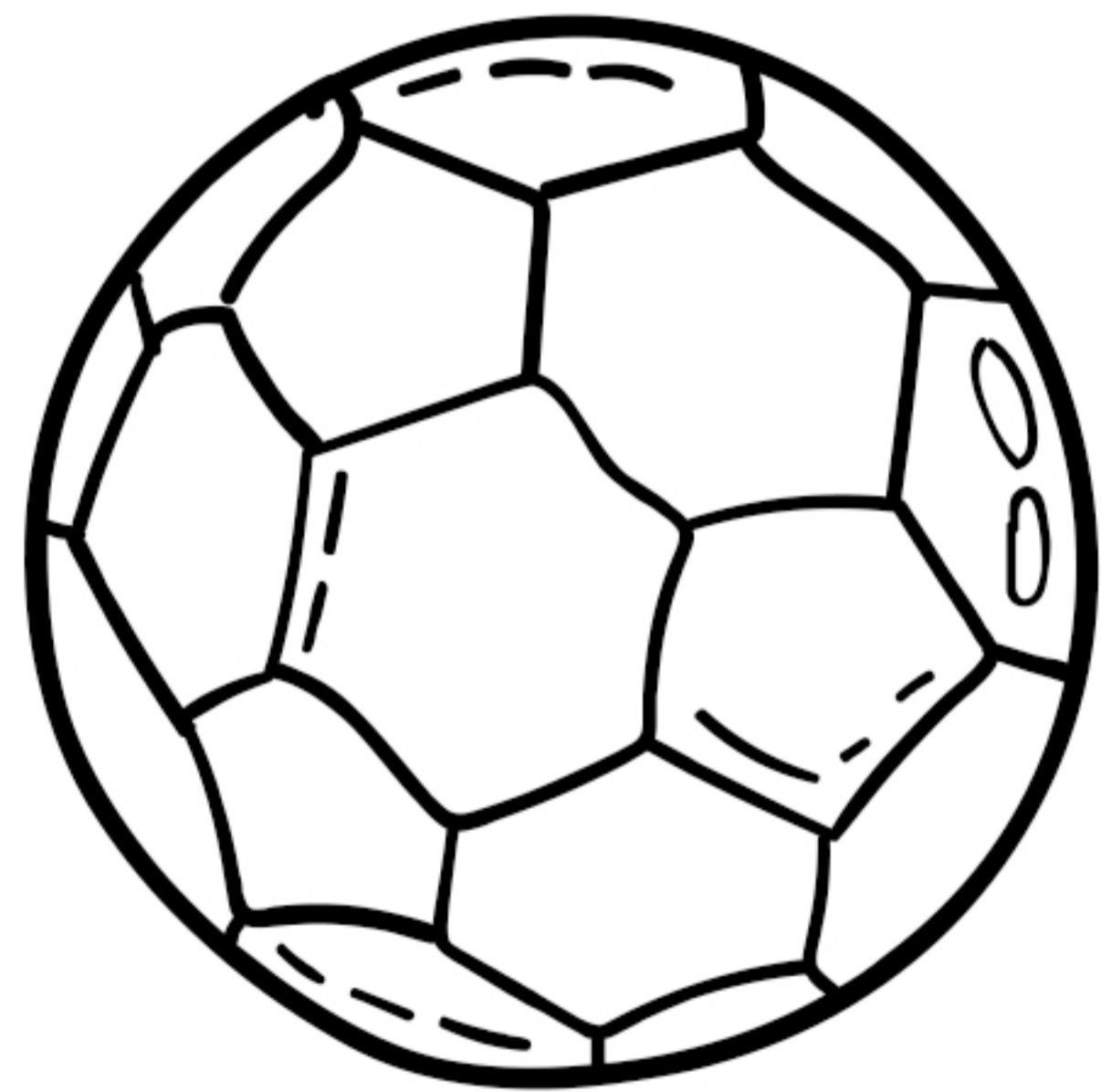

*en fotboll*

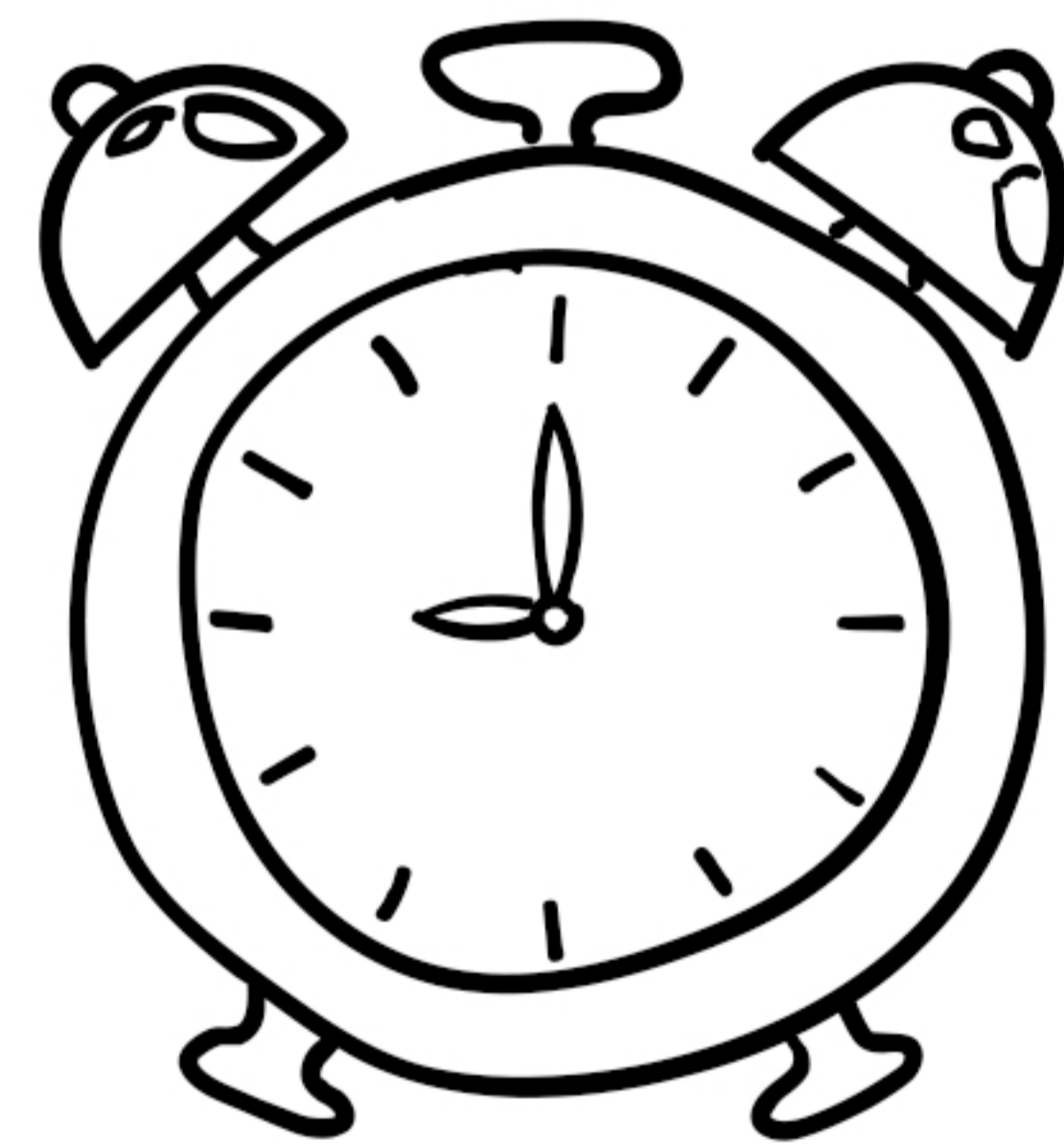

*en klocka*



*en tavla*



*en jordglob*



*en räknare*

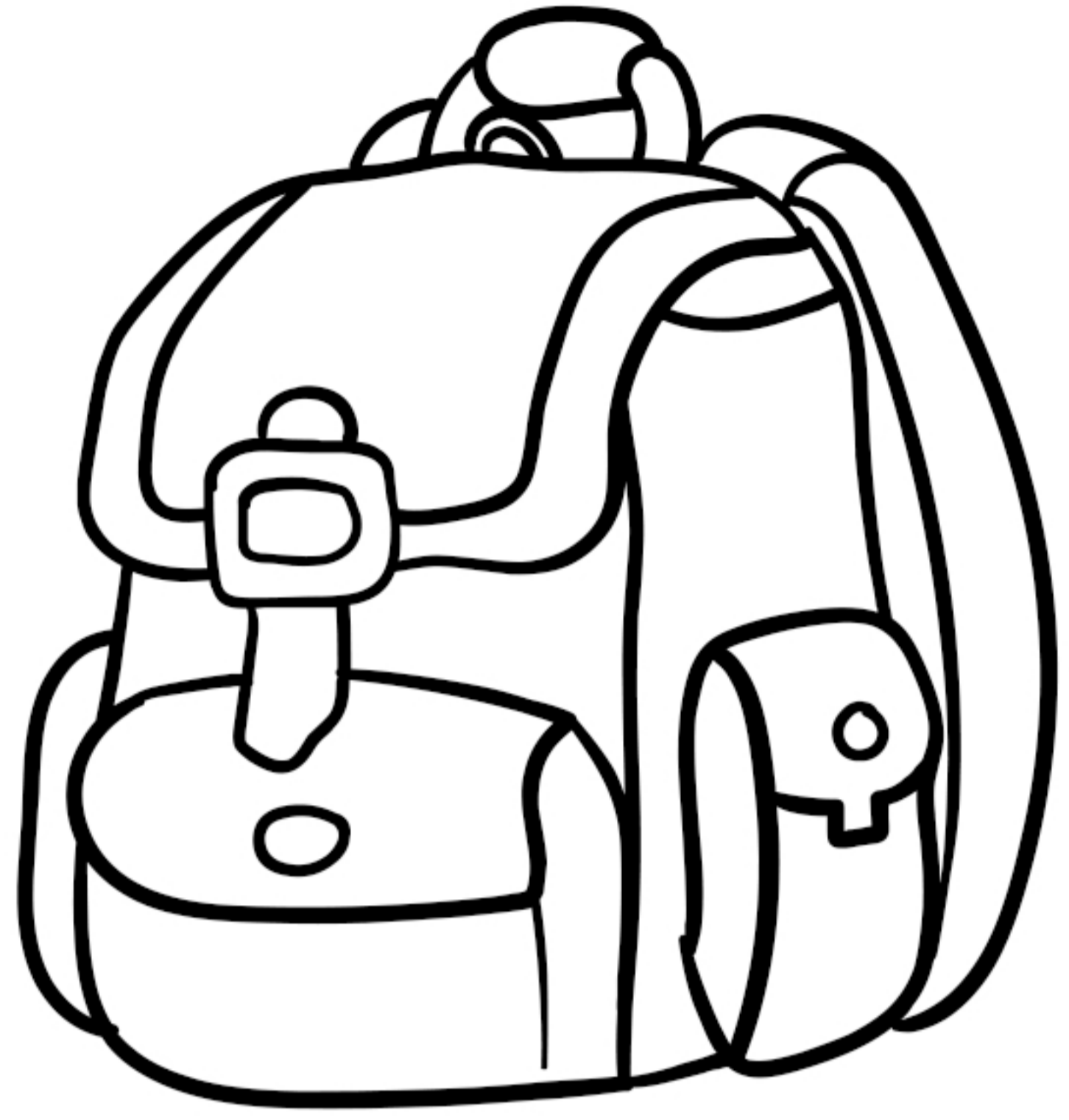

*en ryggsäck*

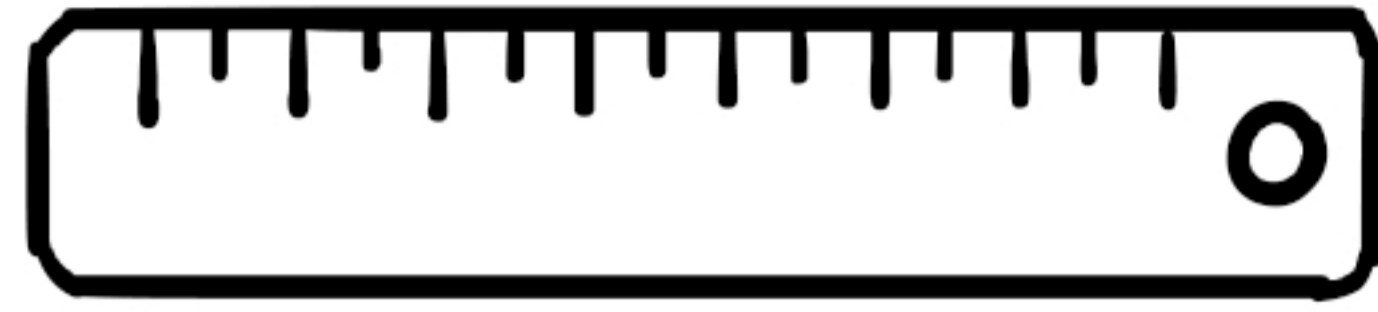

*en linjal*

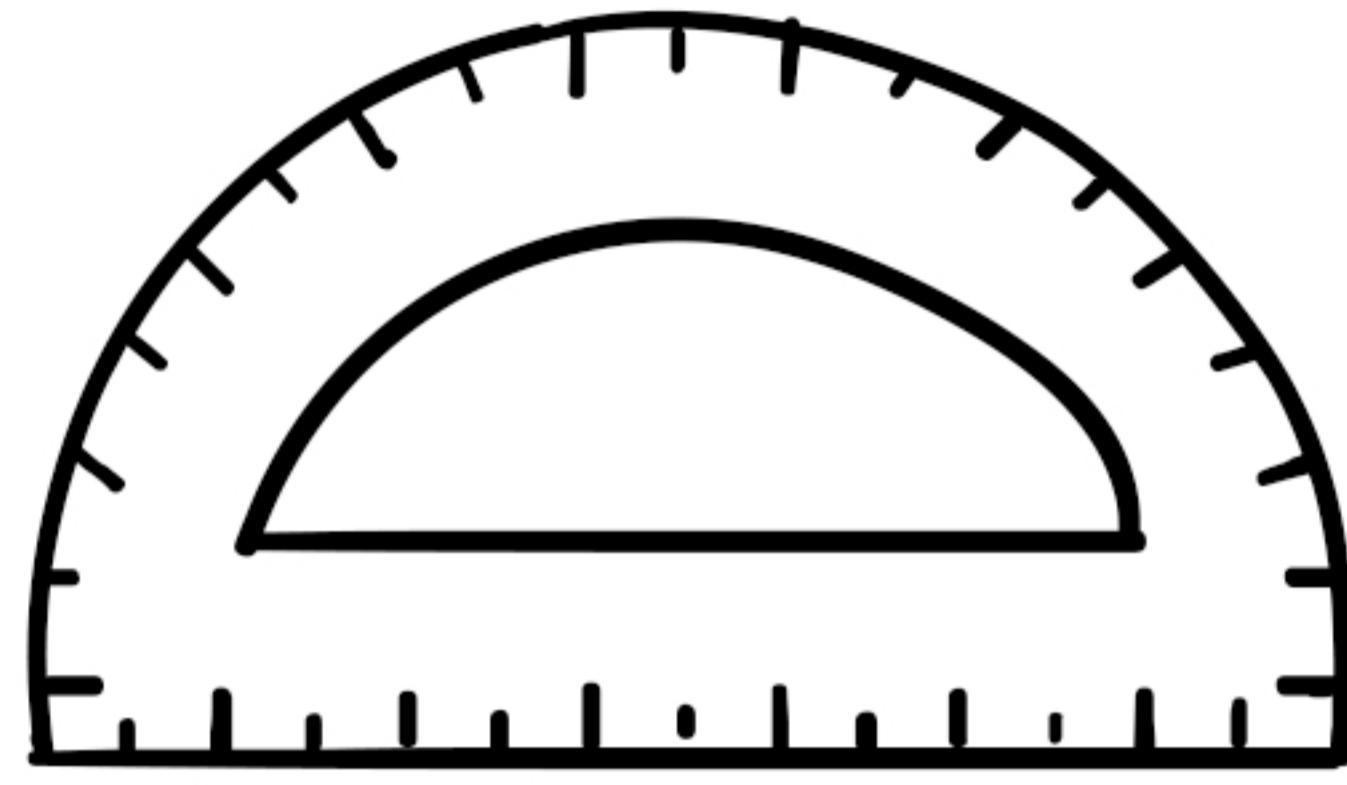

*en gradskiva*

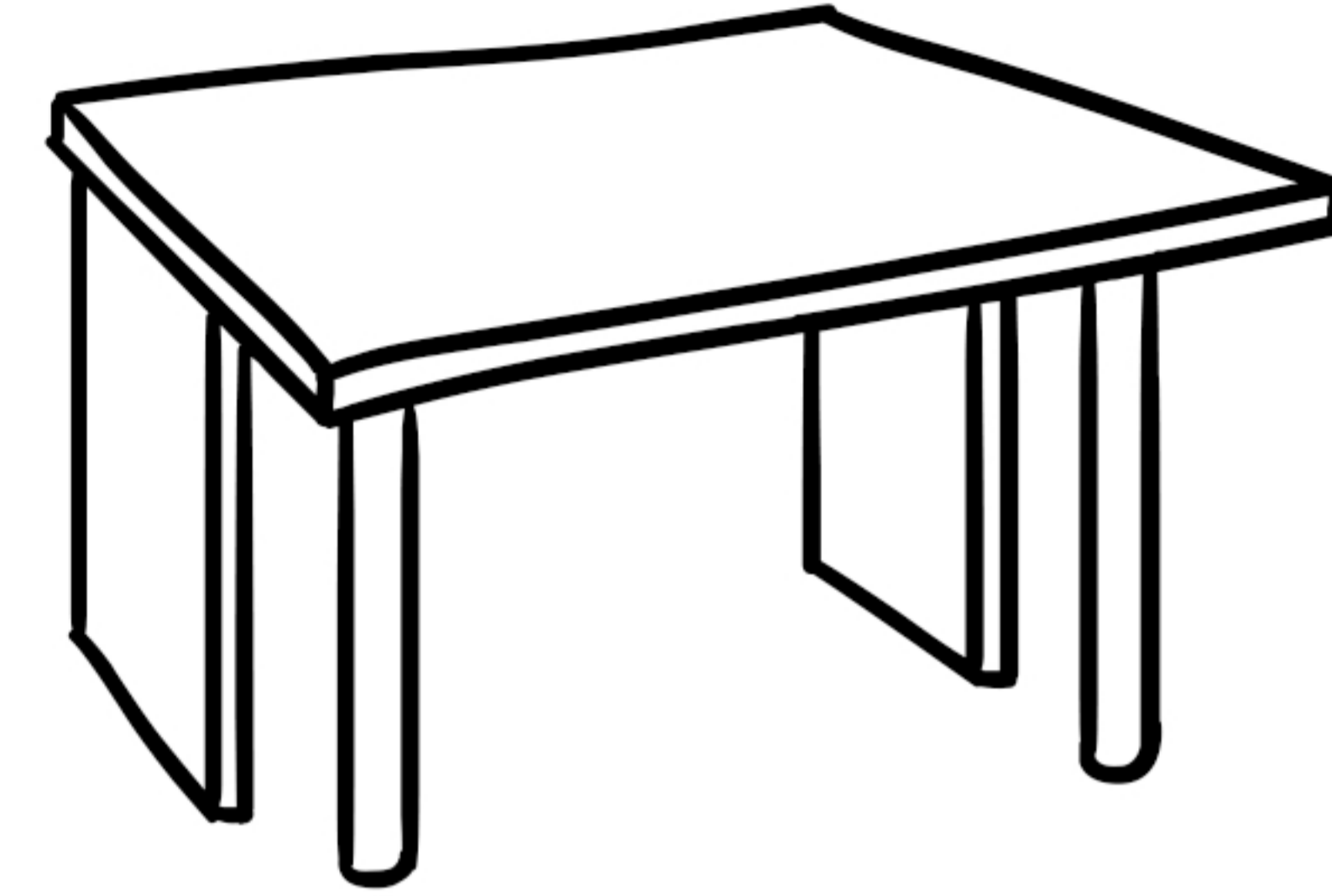

*ett skrivbord*



*en passare*

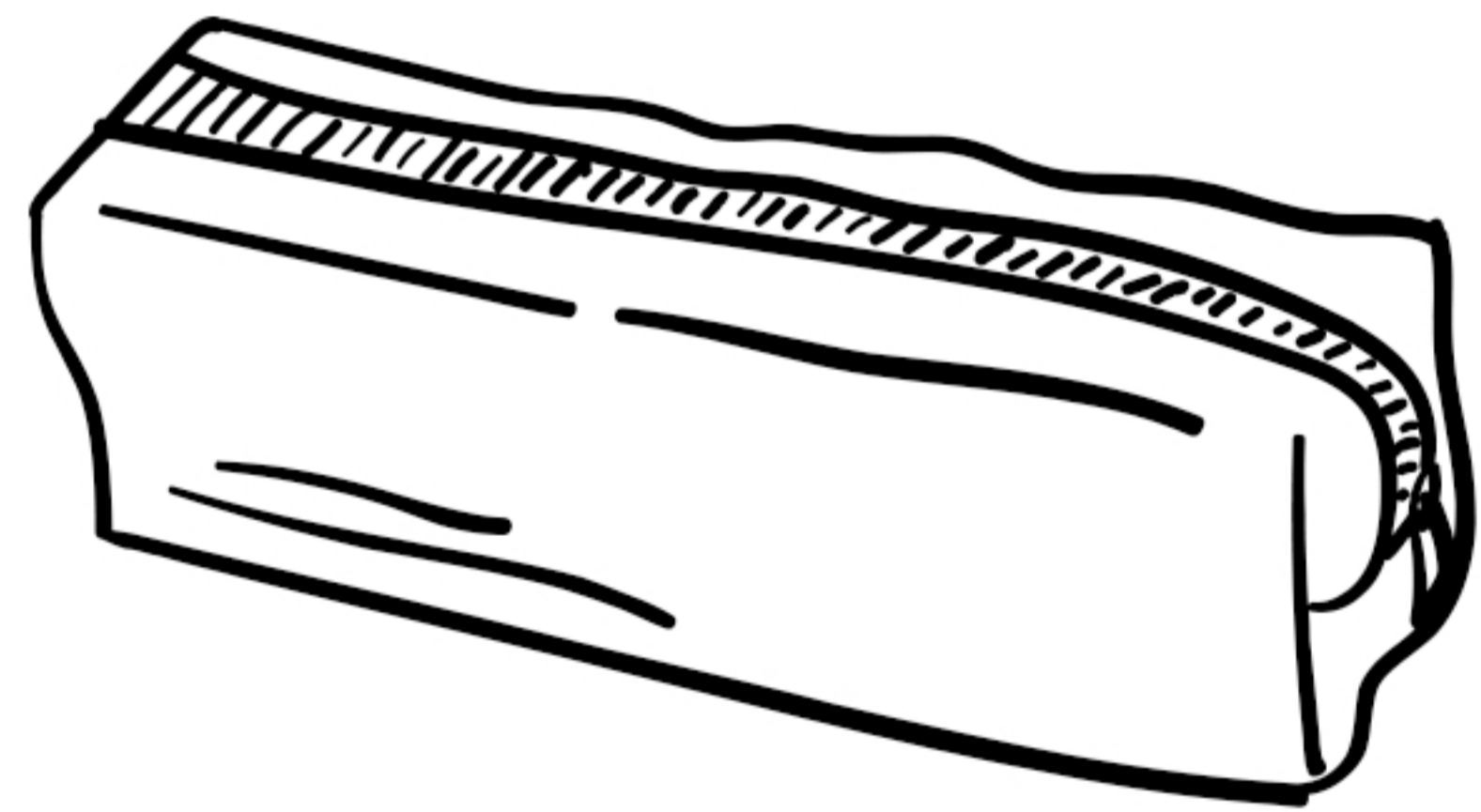

*ett pennfodral*

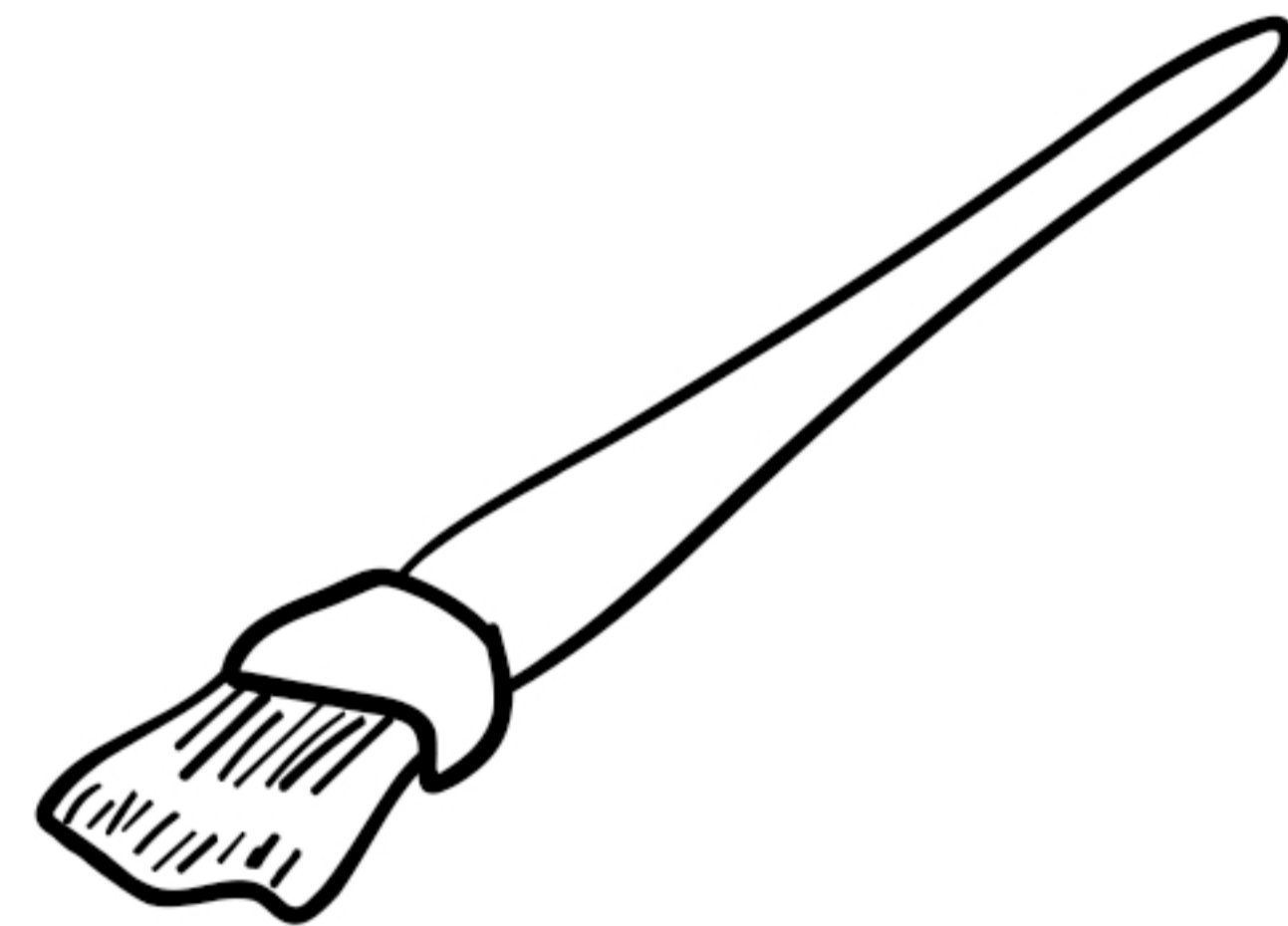

*en pensel*

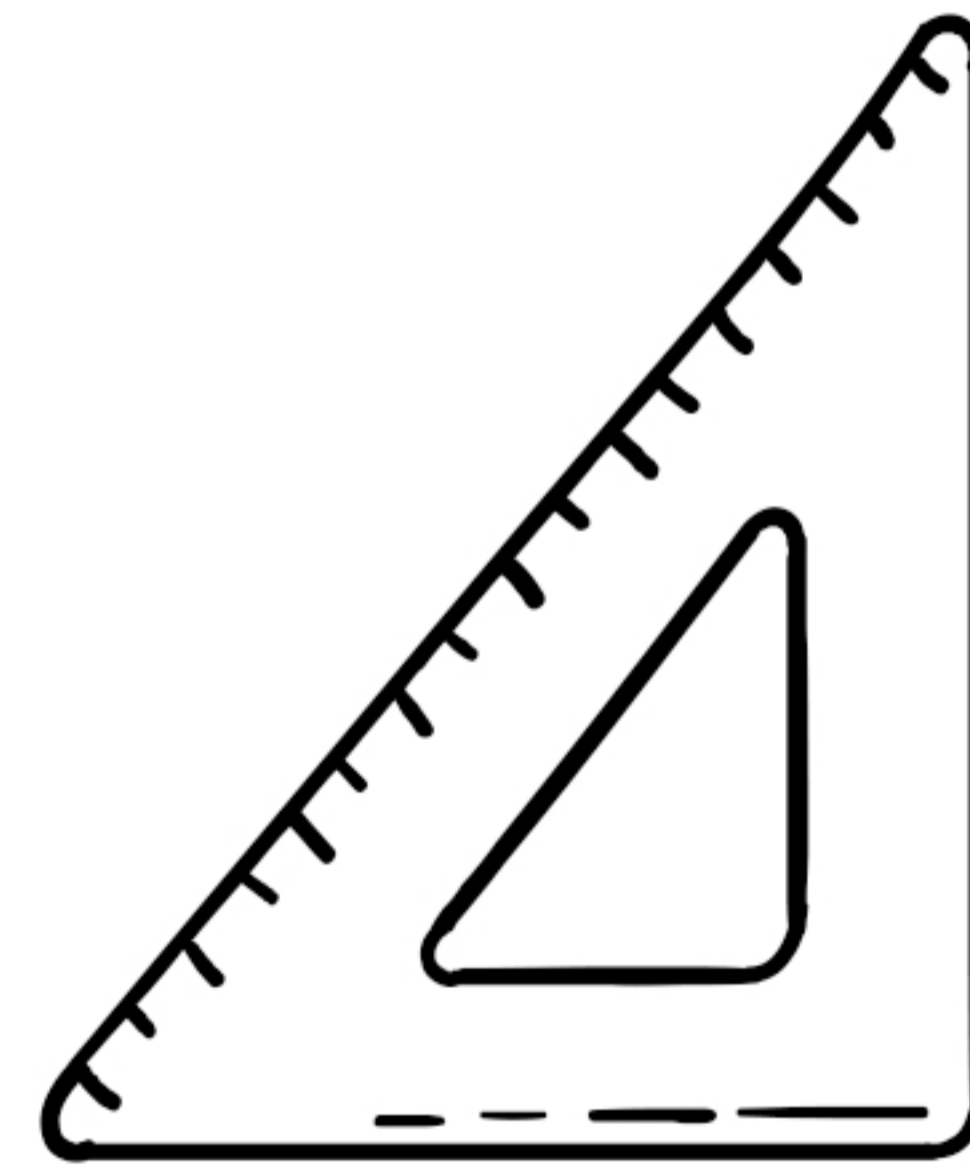

*en vinkellinjal*

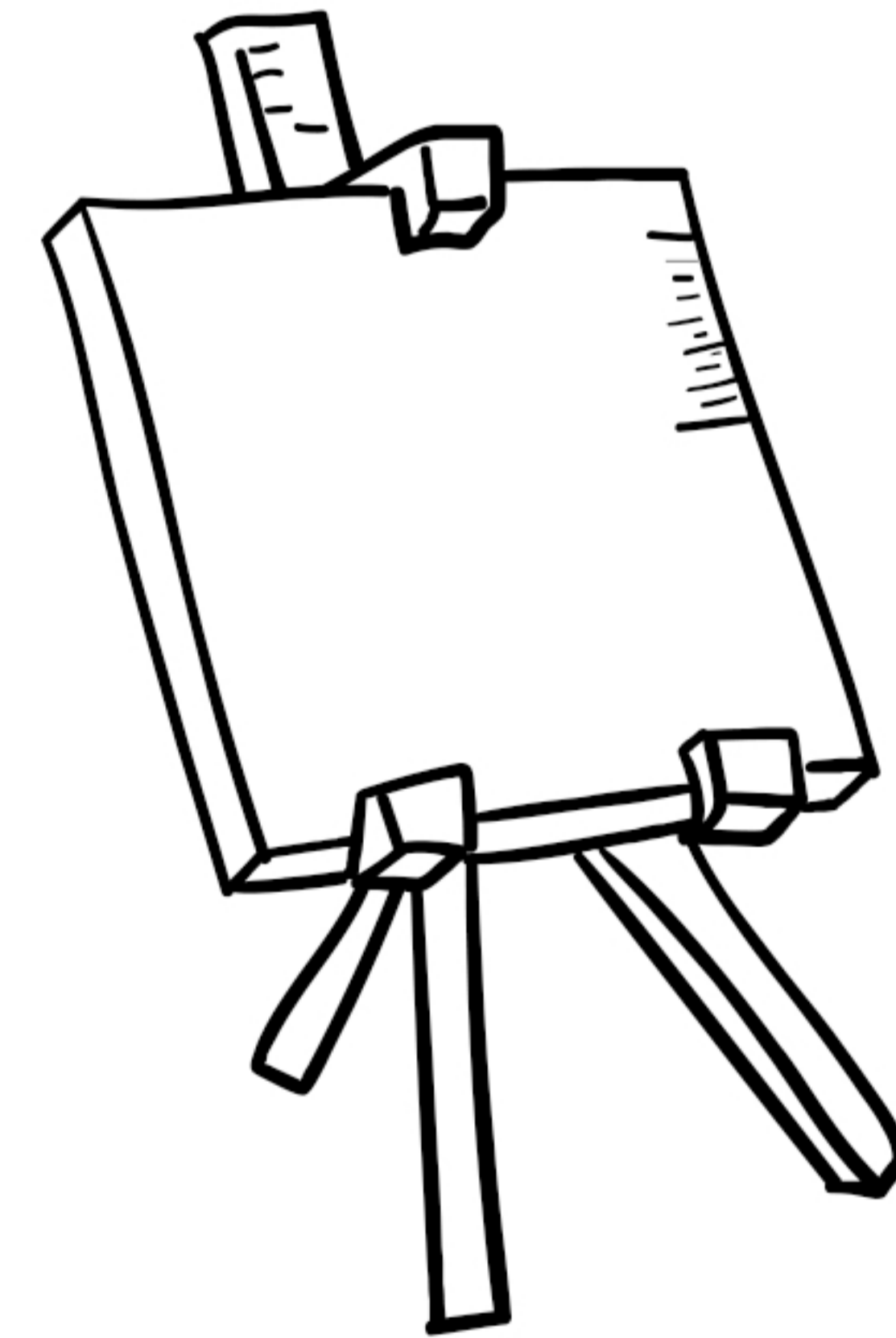

*ett staffli*

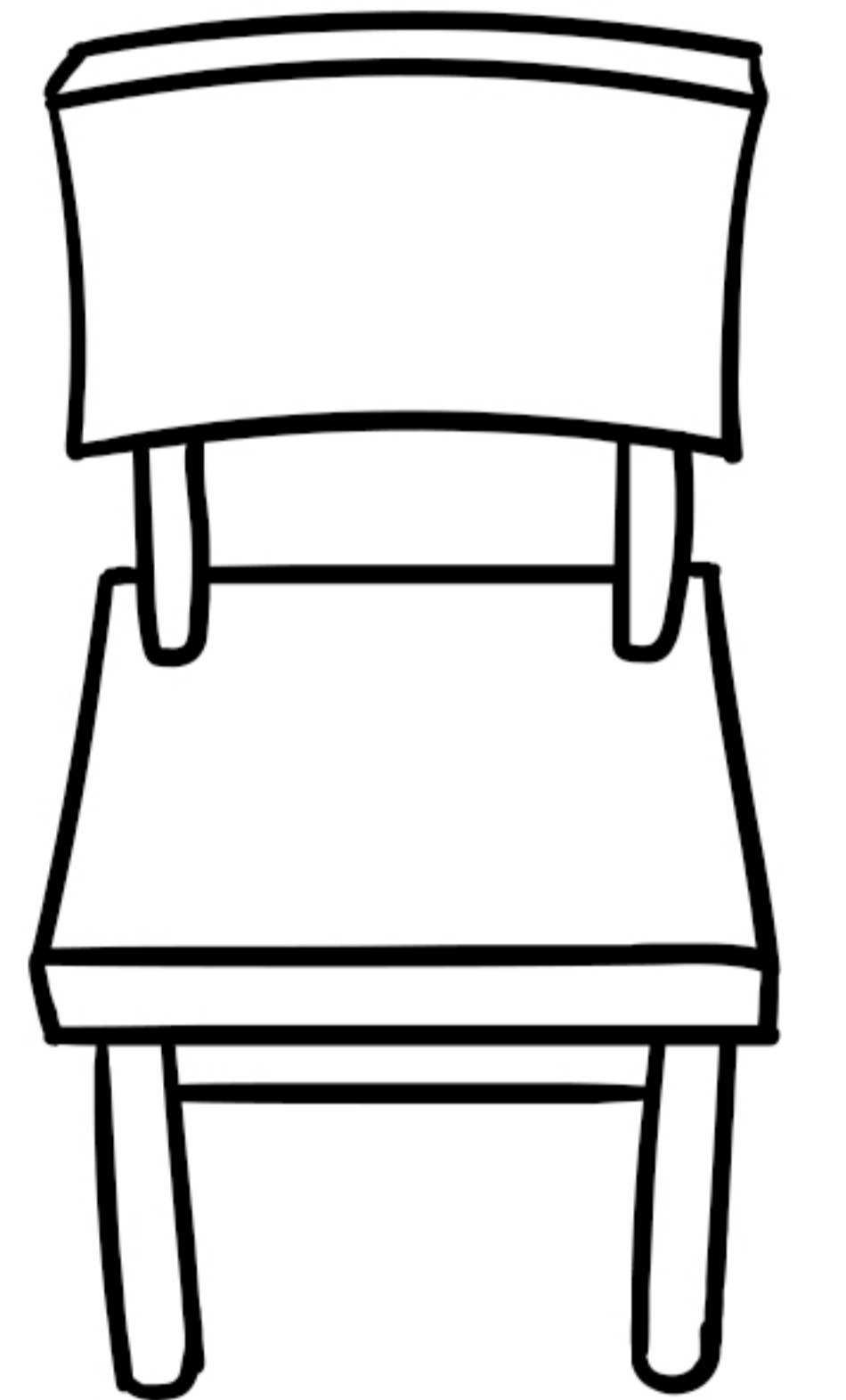

*en stol*

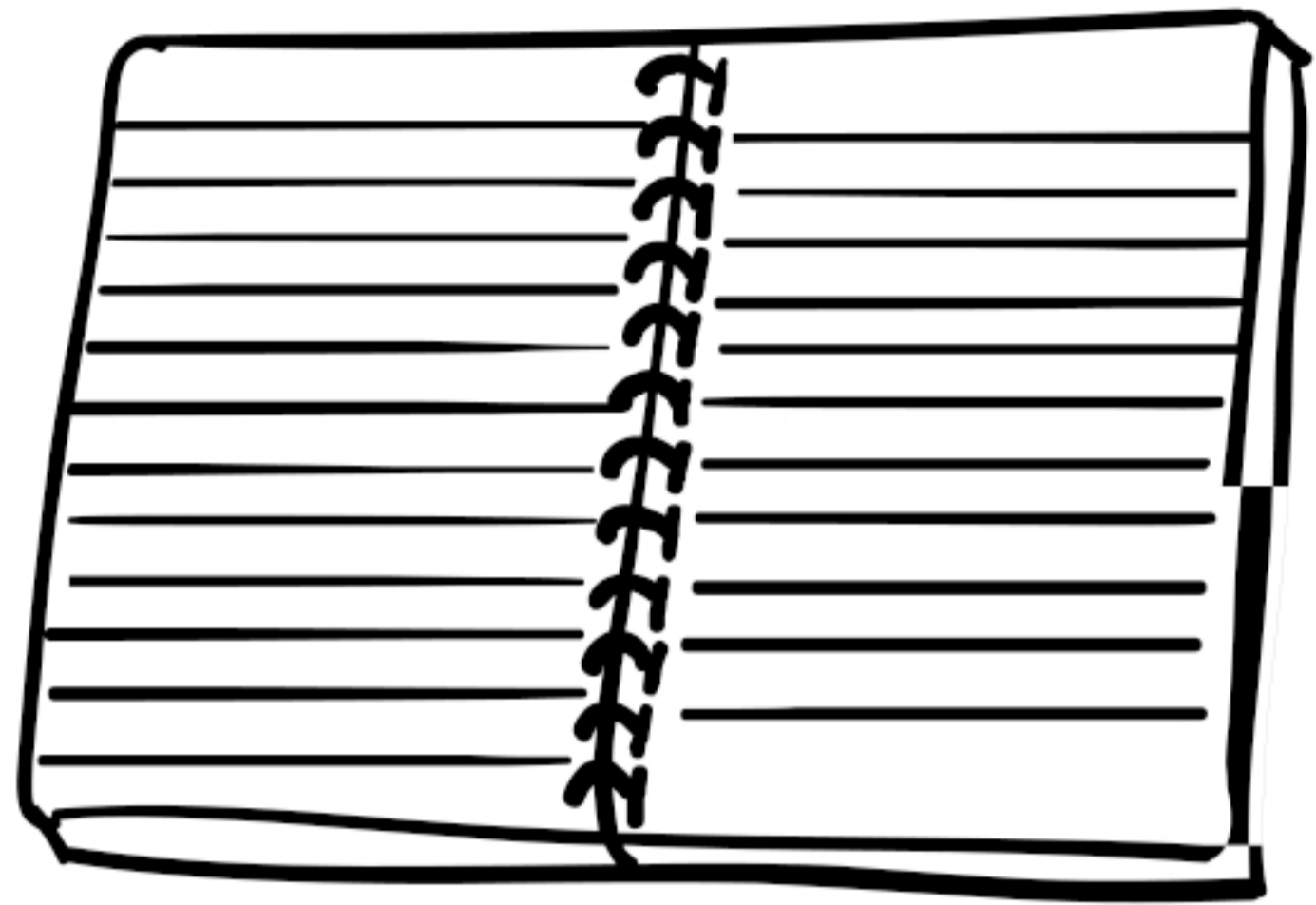

*ett skrivhäfte*

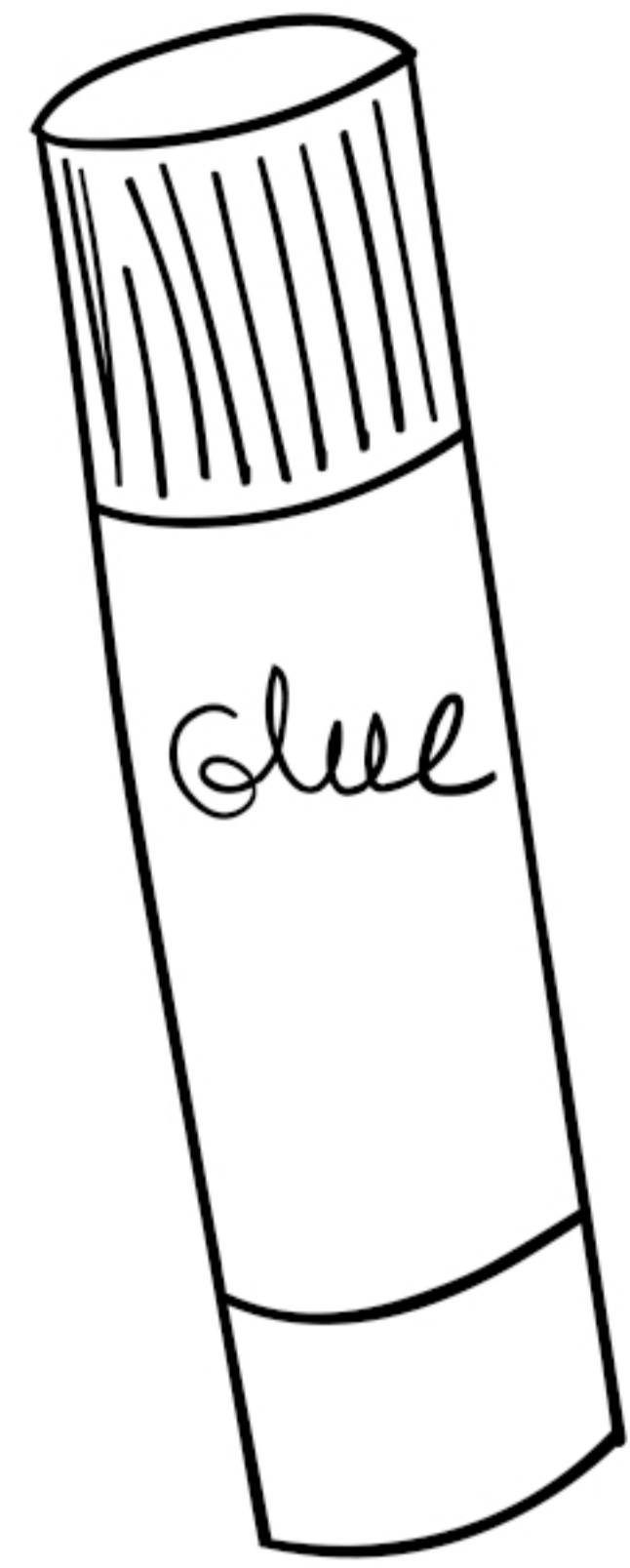

*ett limstift*

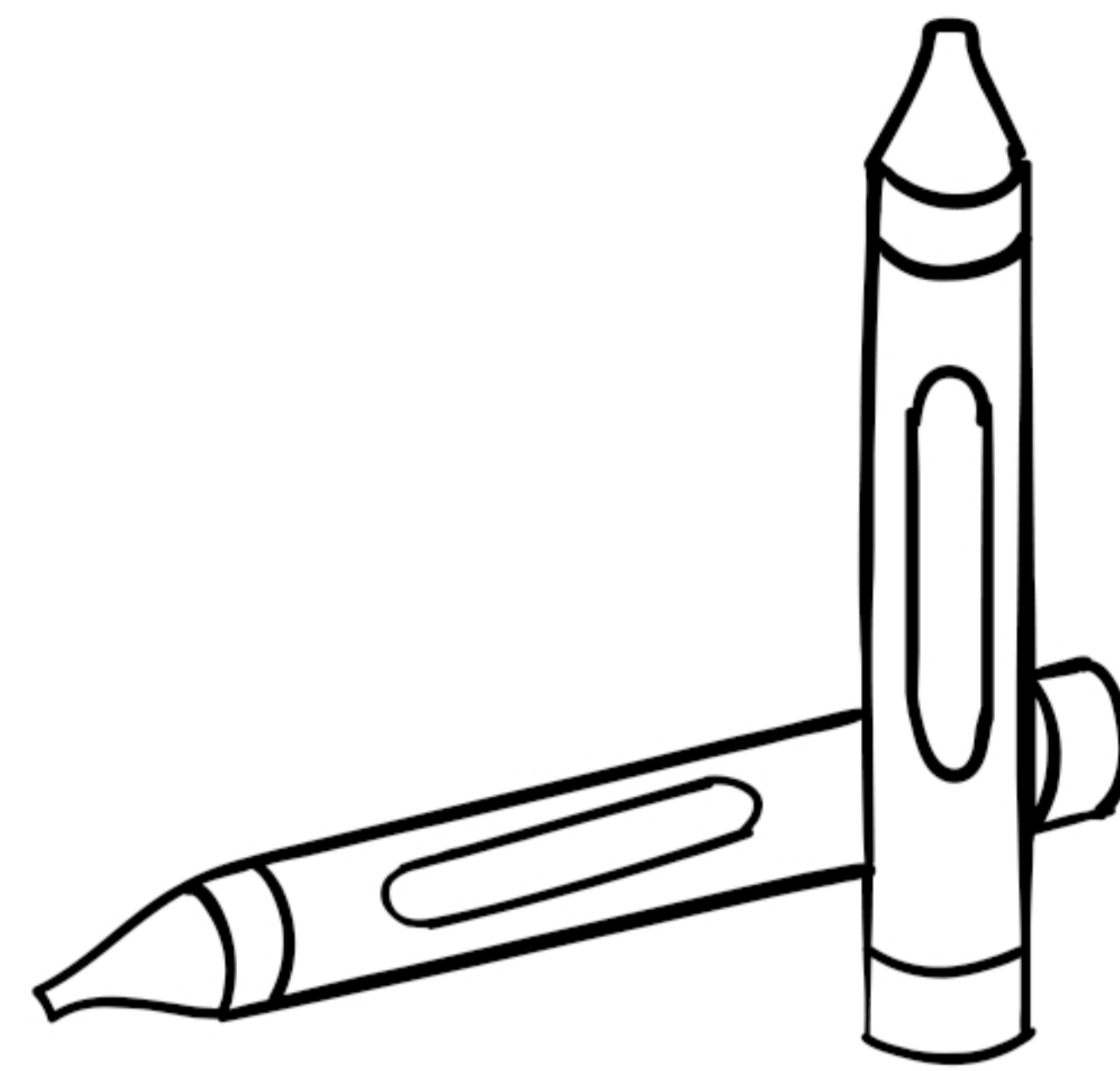

*två kriter*

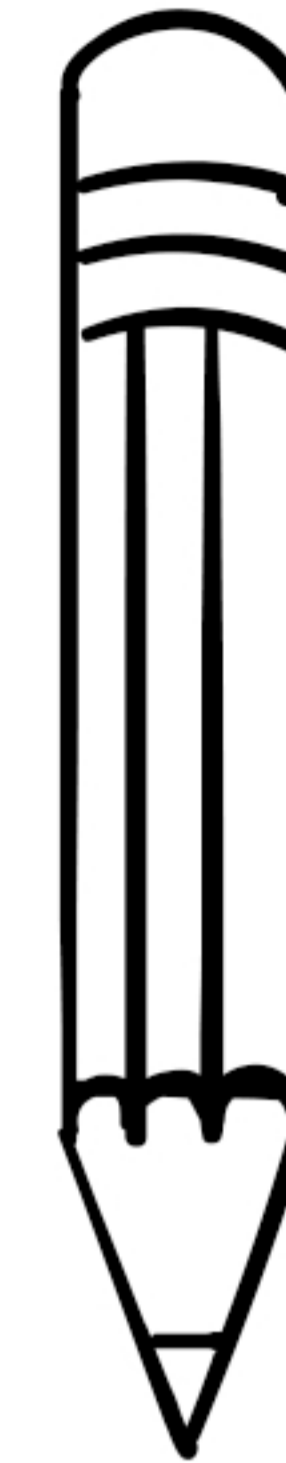

*en penna*

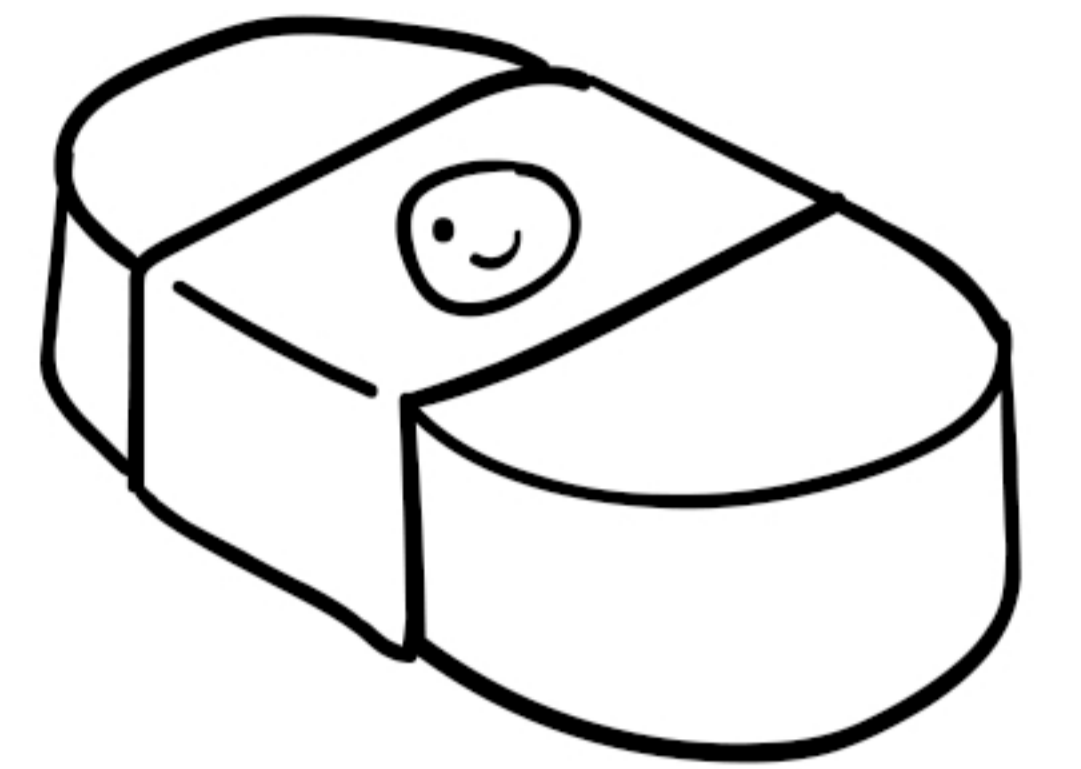

*ett sudd*

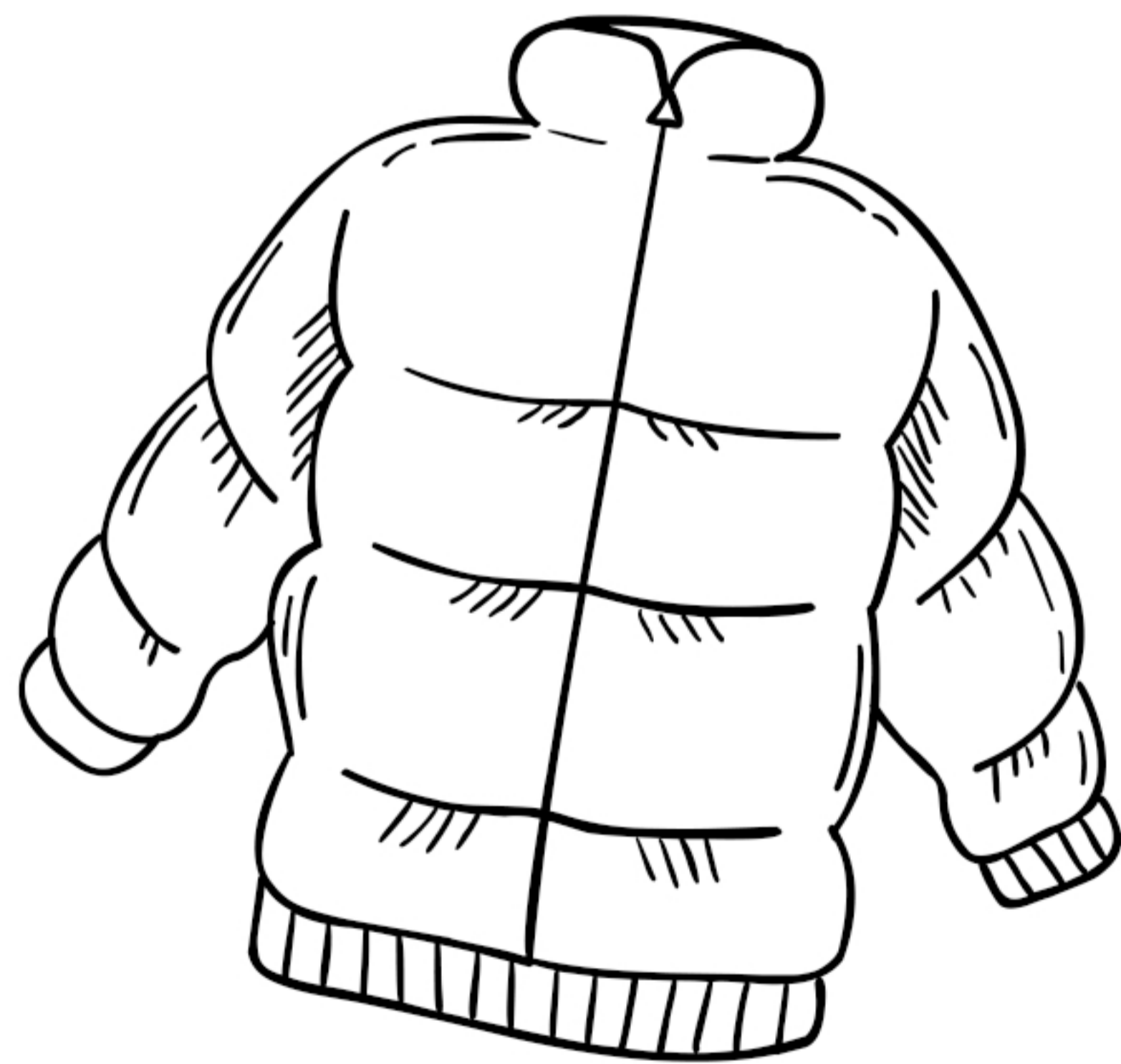

*en jacka*

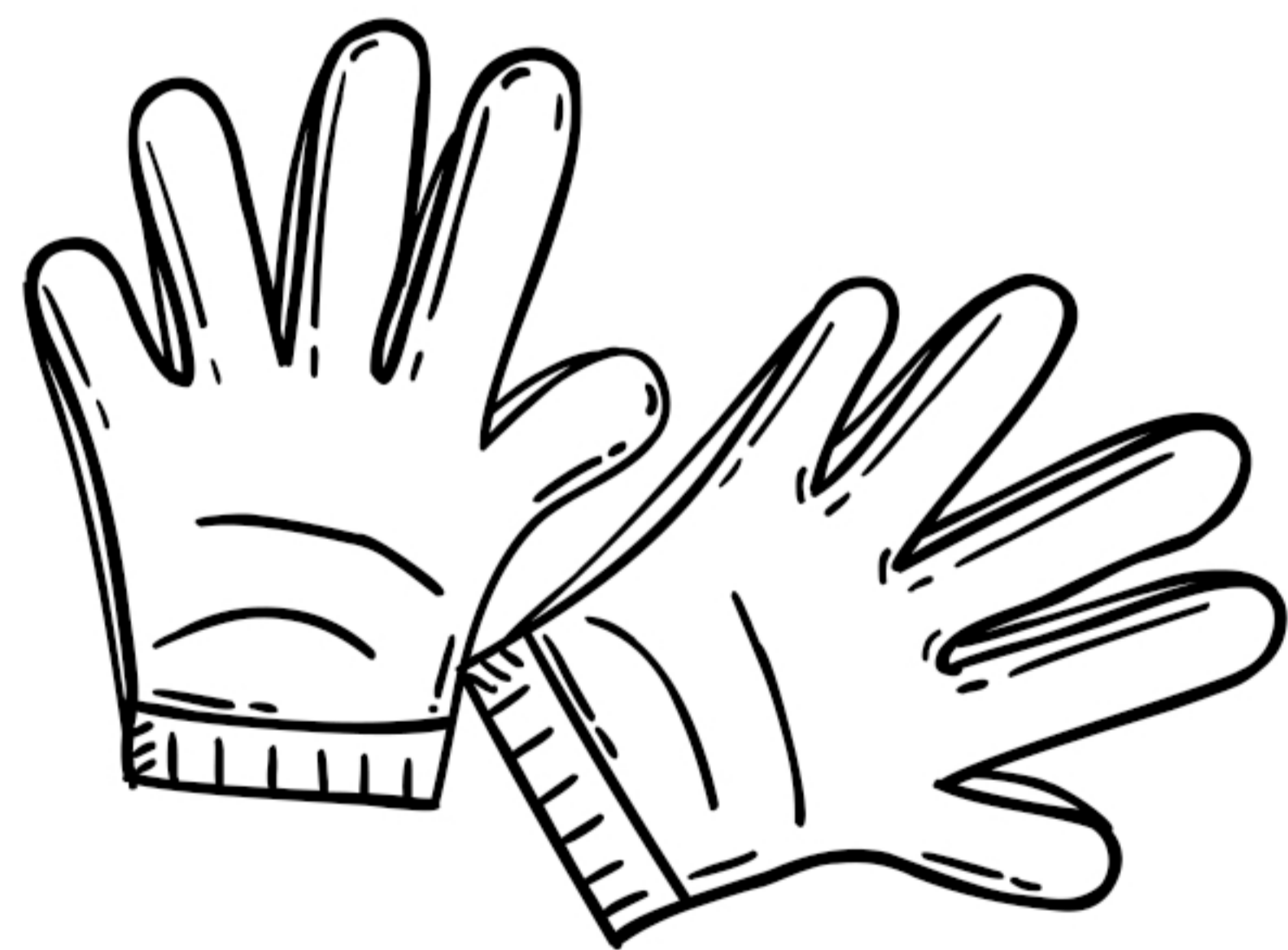

*ett par handskar*

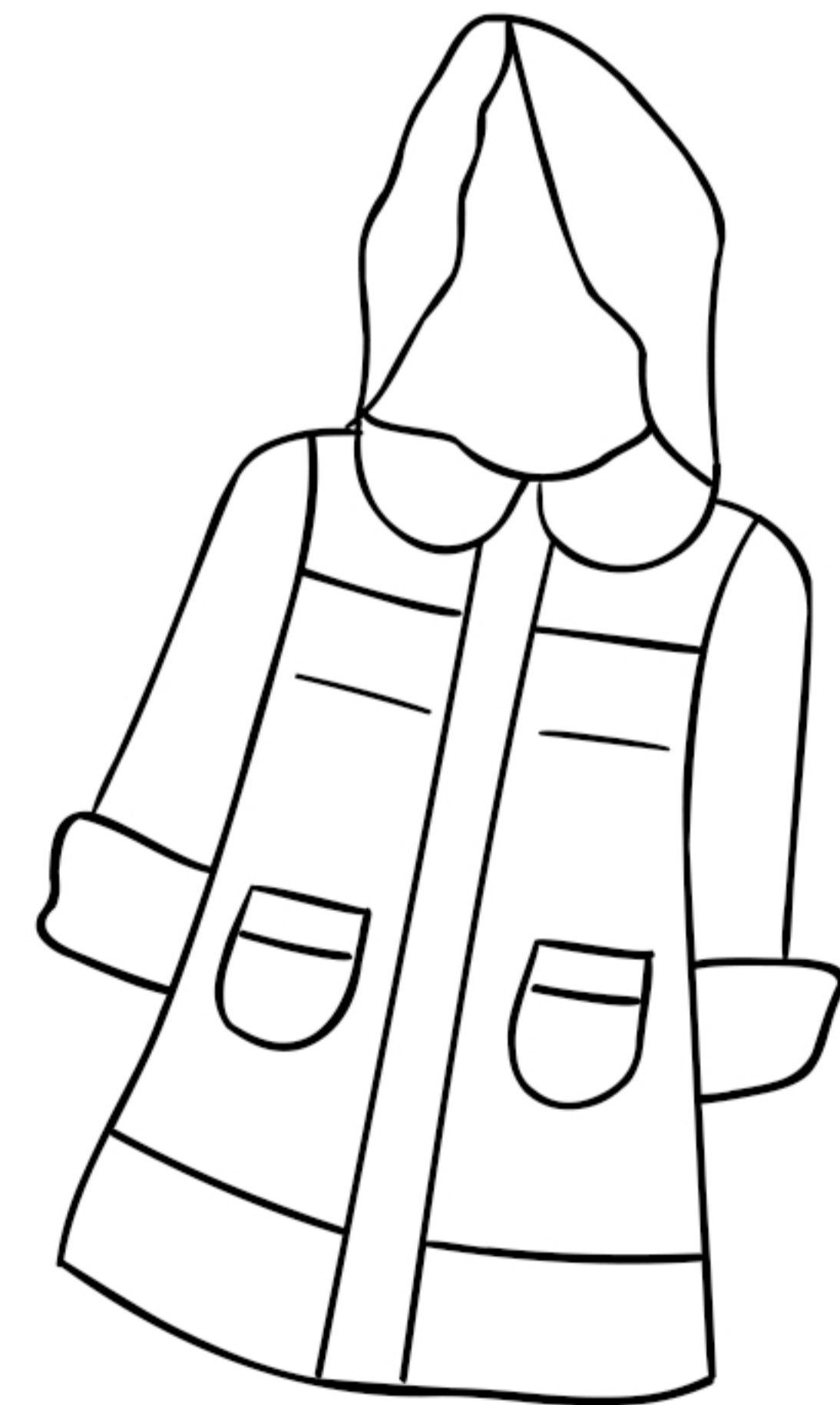

*en kappa*

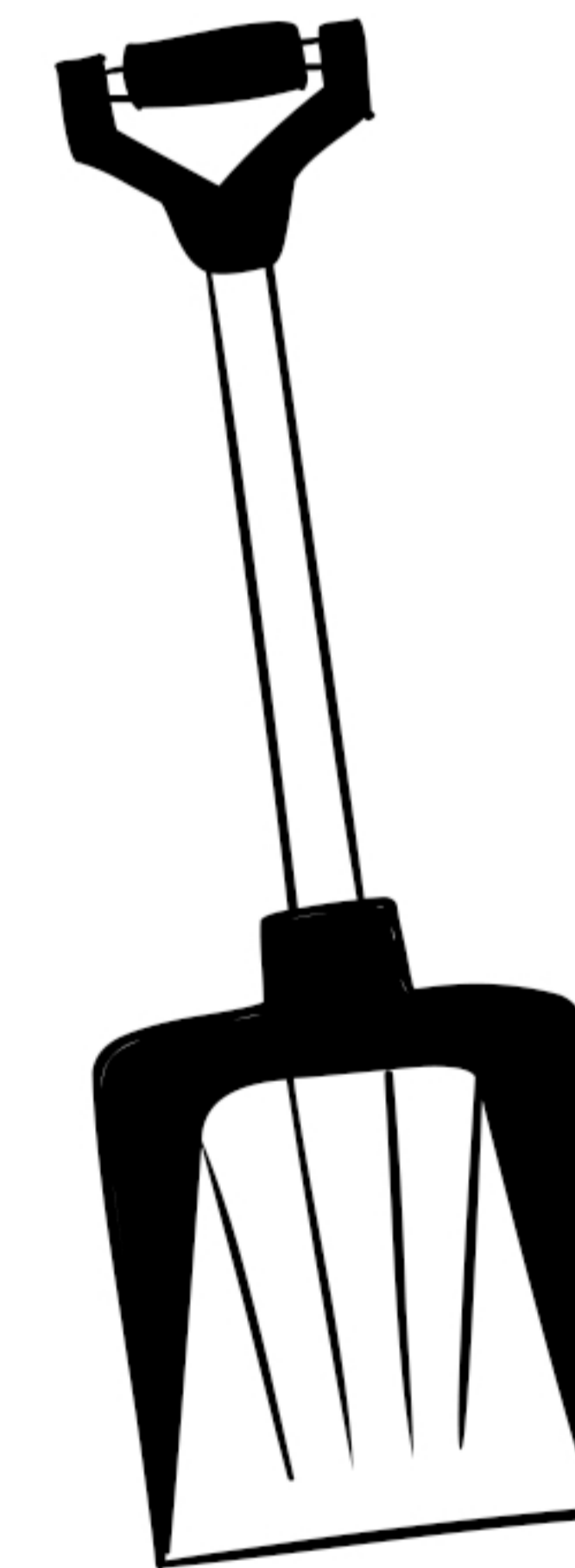

*en skyffel*

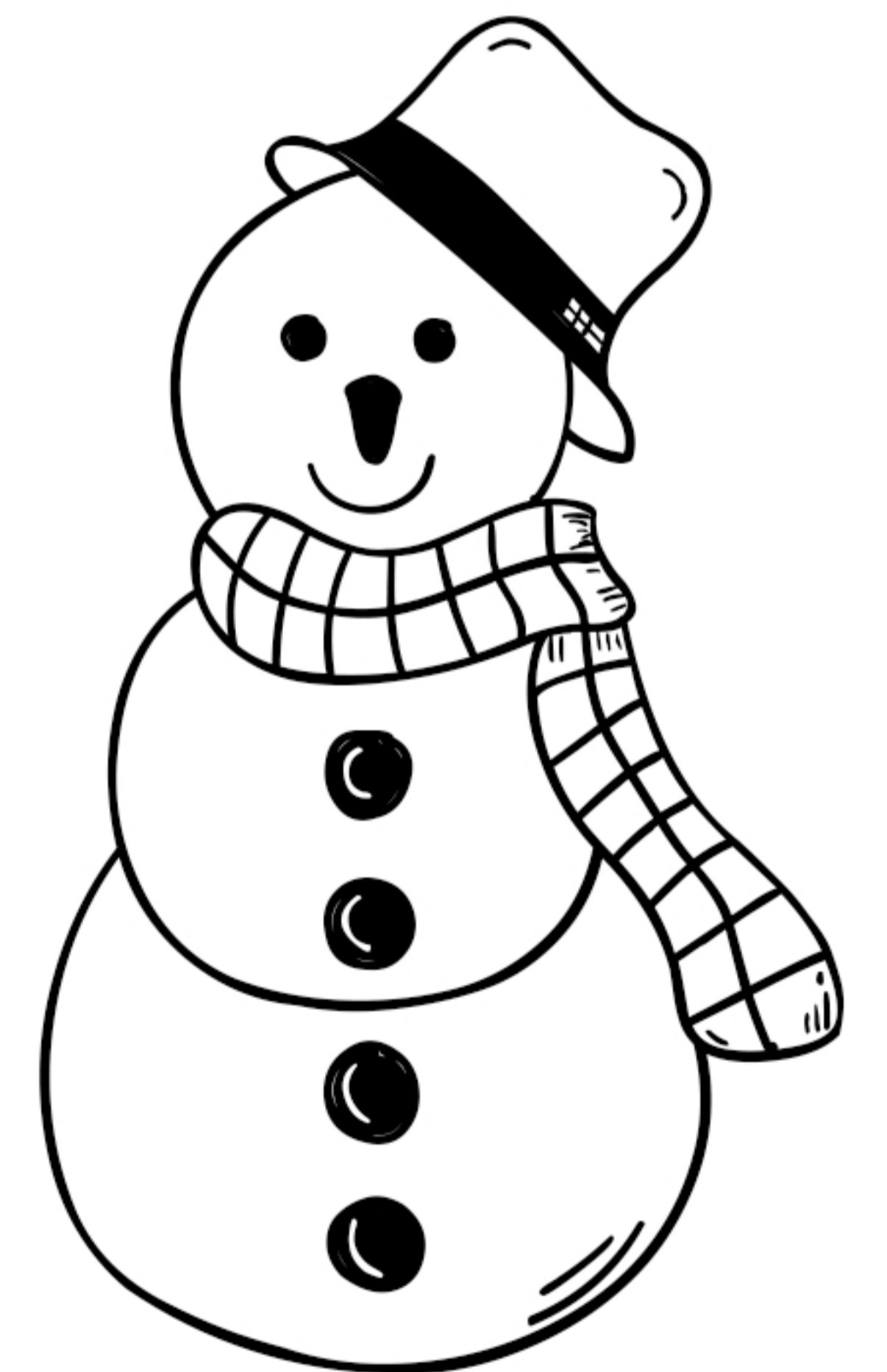

*en snögubbe*

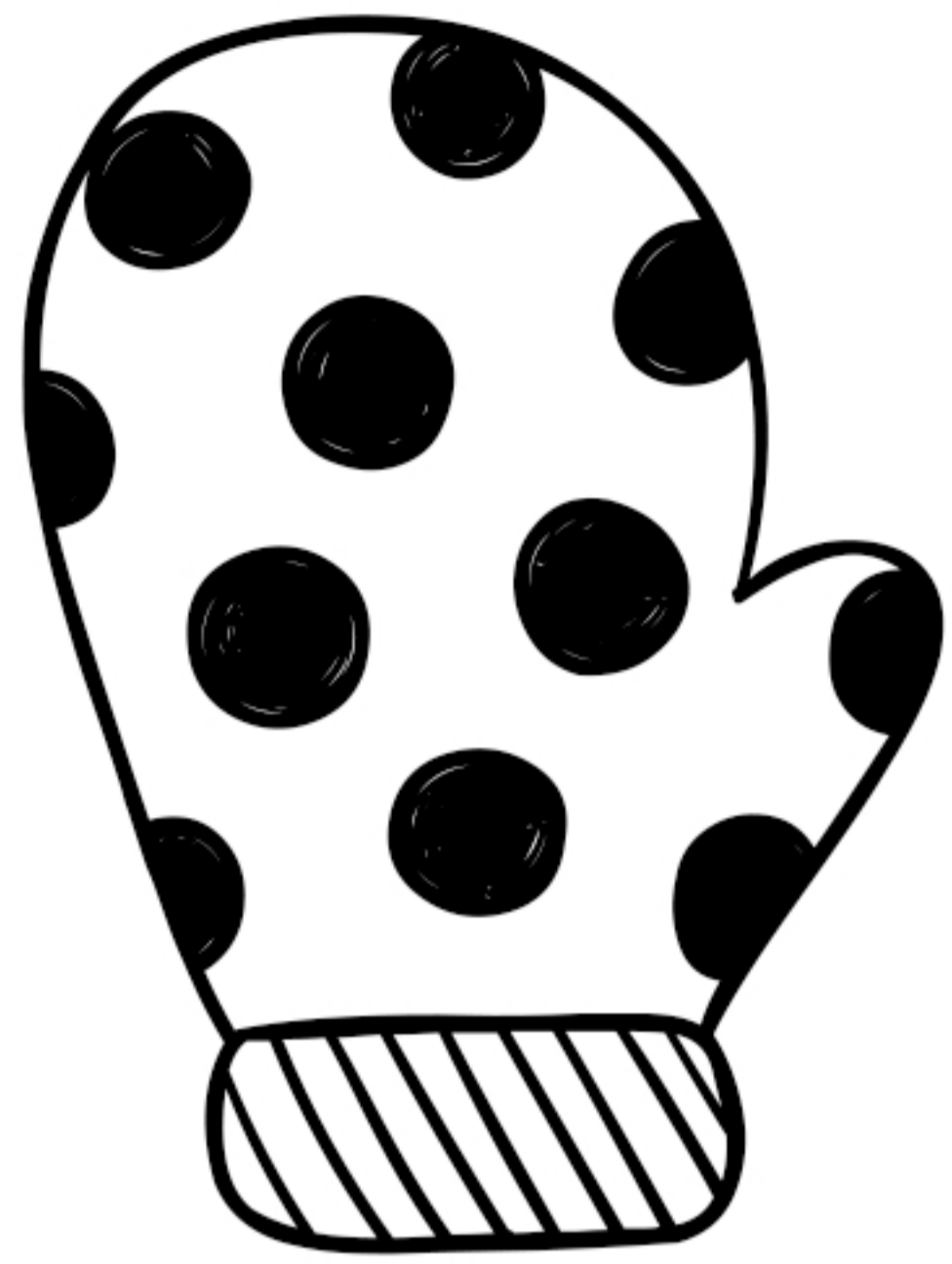

*en vante*

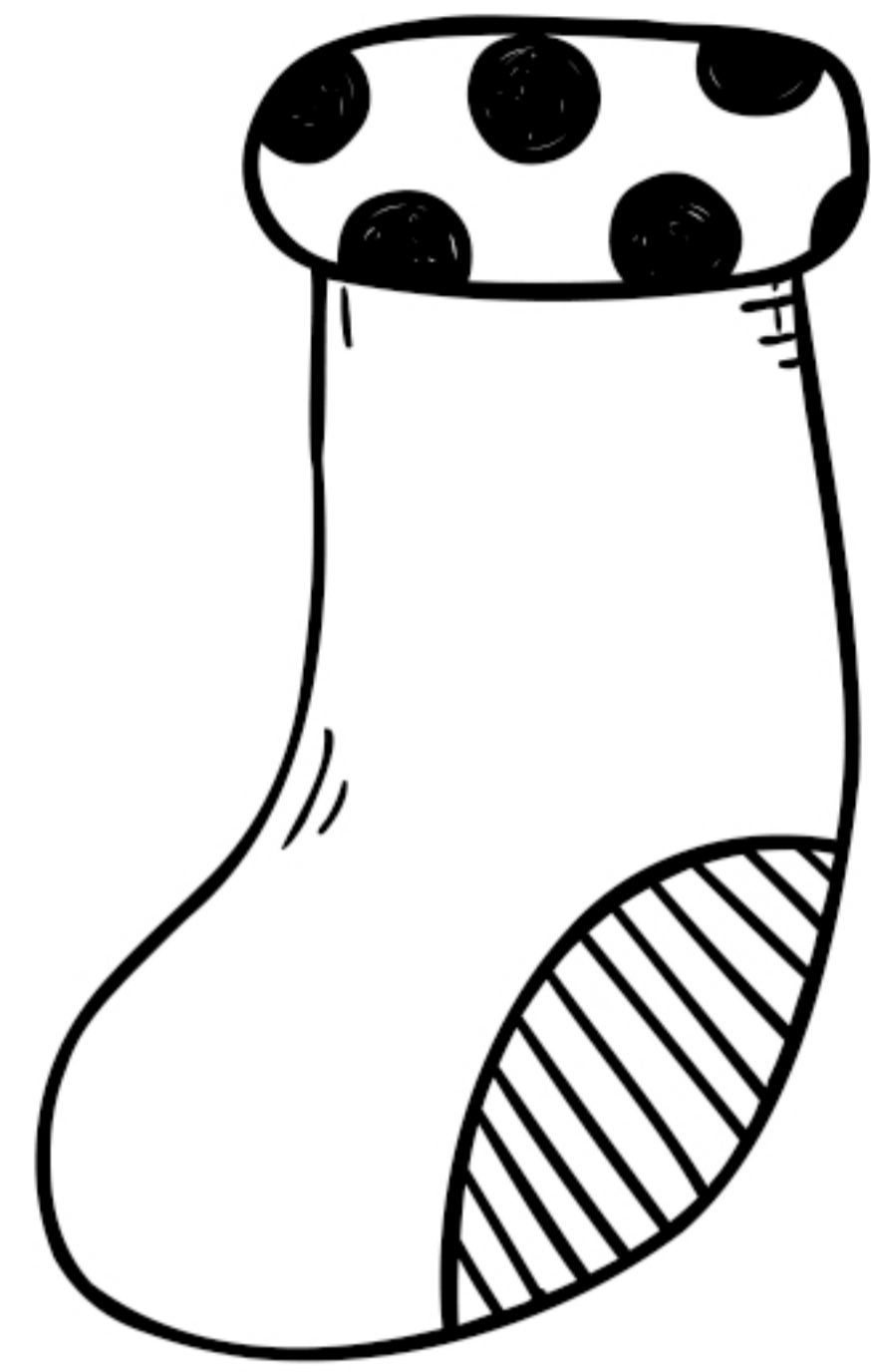

*en socka*



*en mössa*

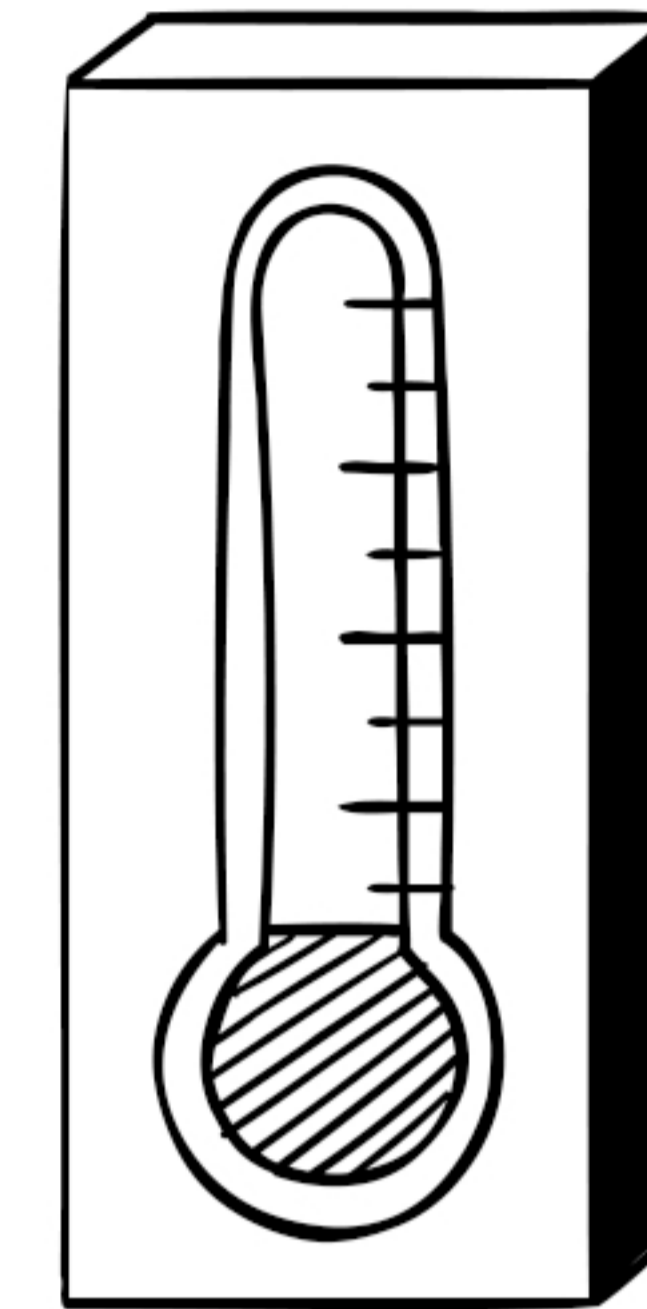

*en termometer*

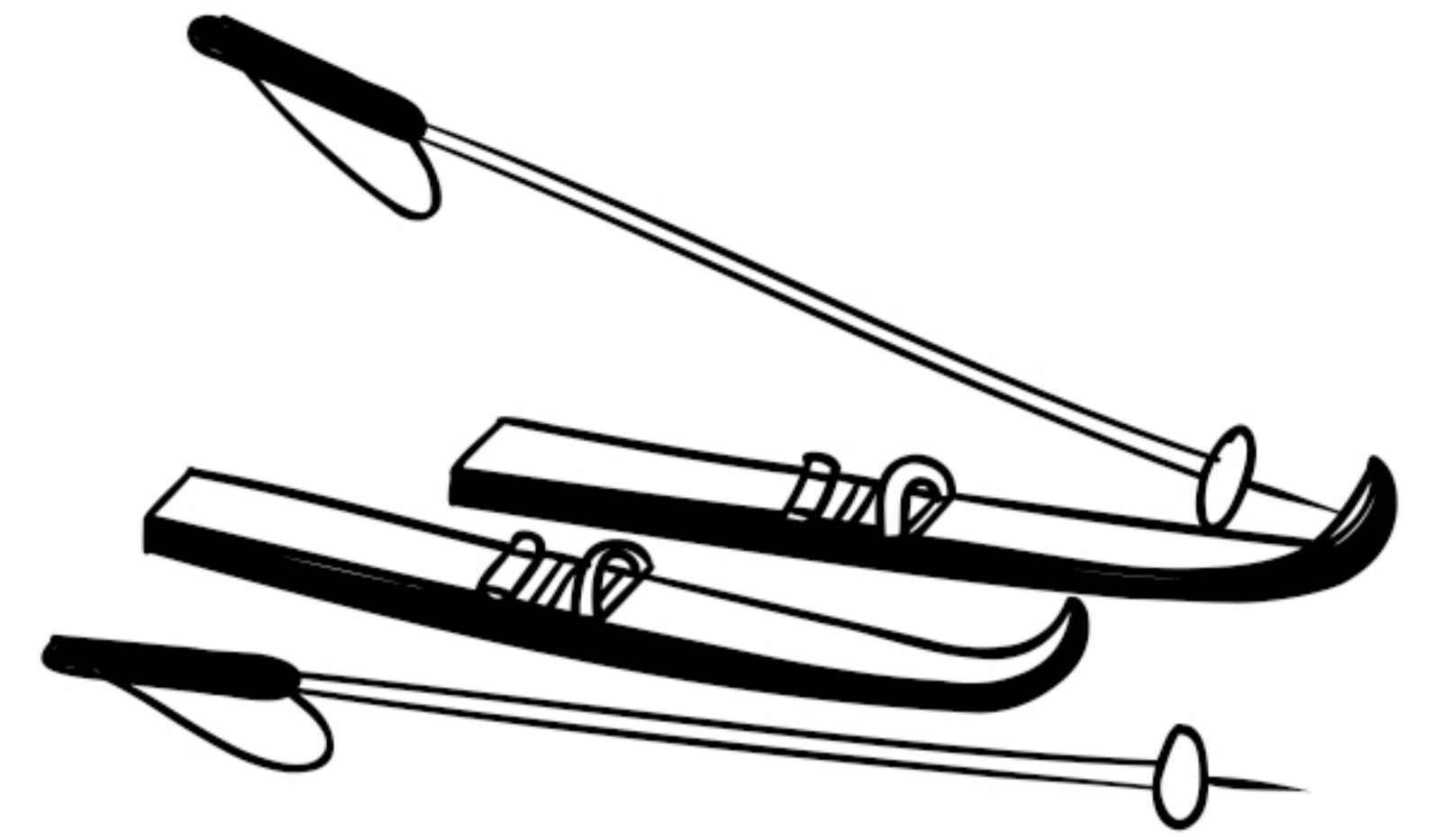

*ett par skidor*



*ett par kängor*



*ett par skridskor*



*en brasa*



*två moln*



*en snöflinga*

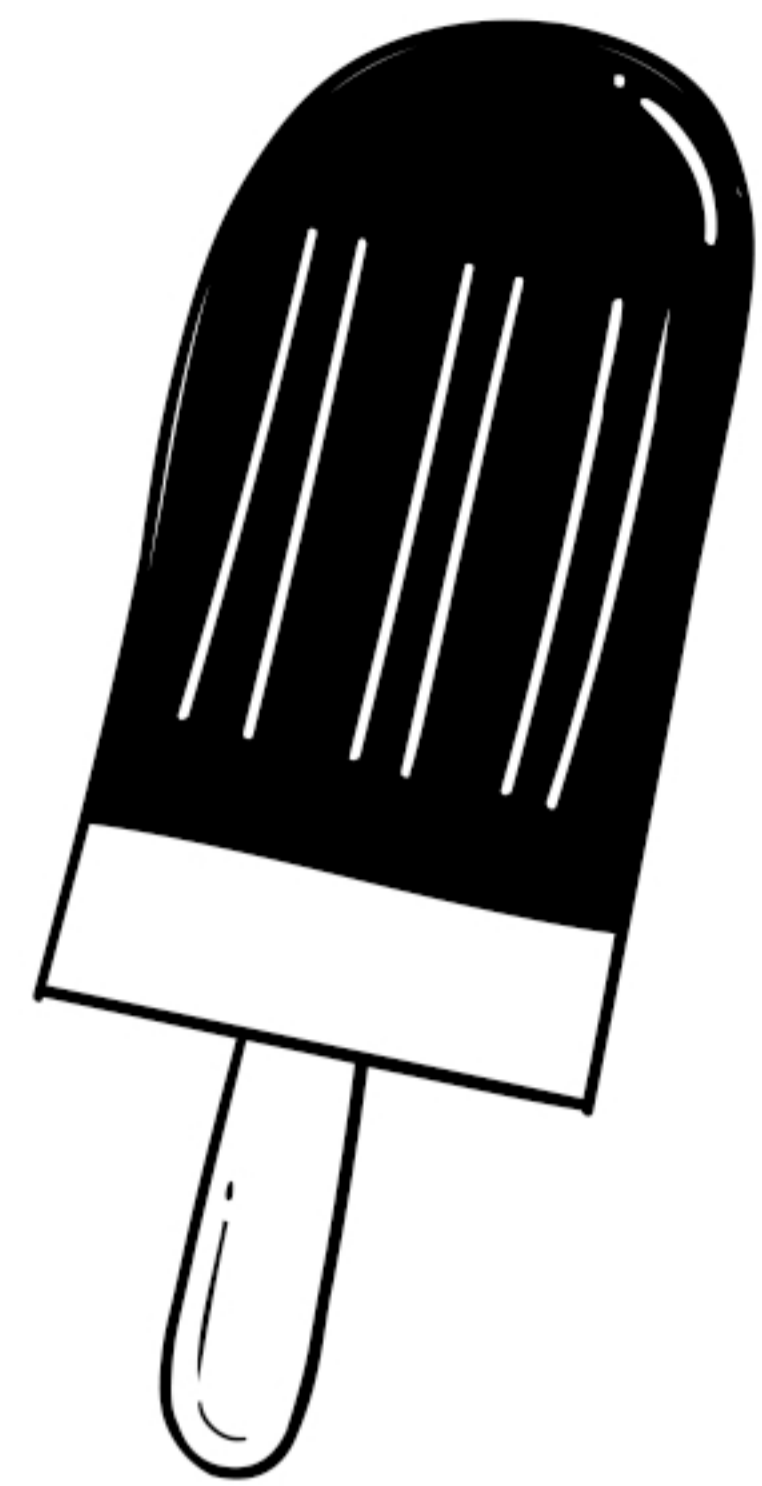

*en pinnglass*

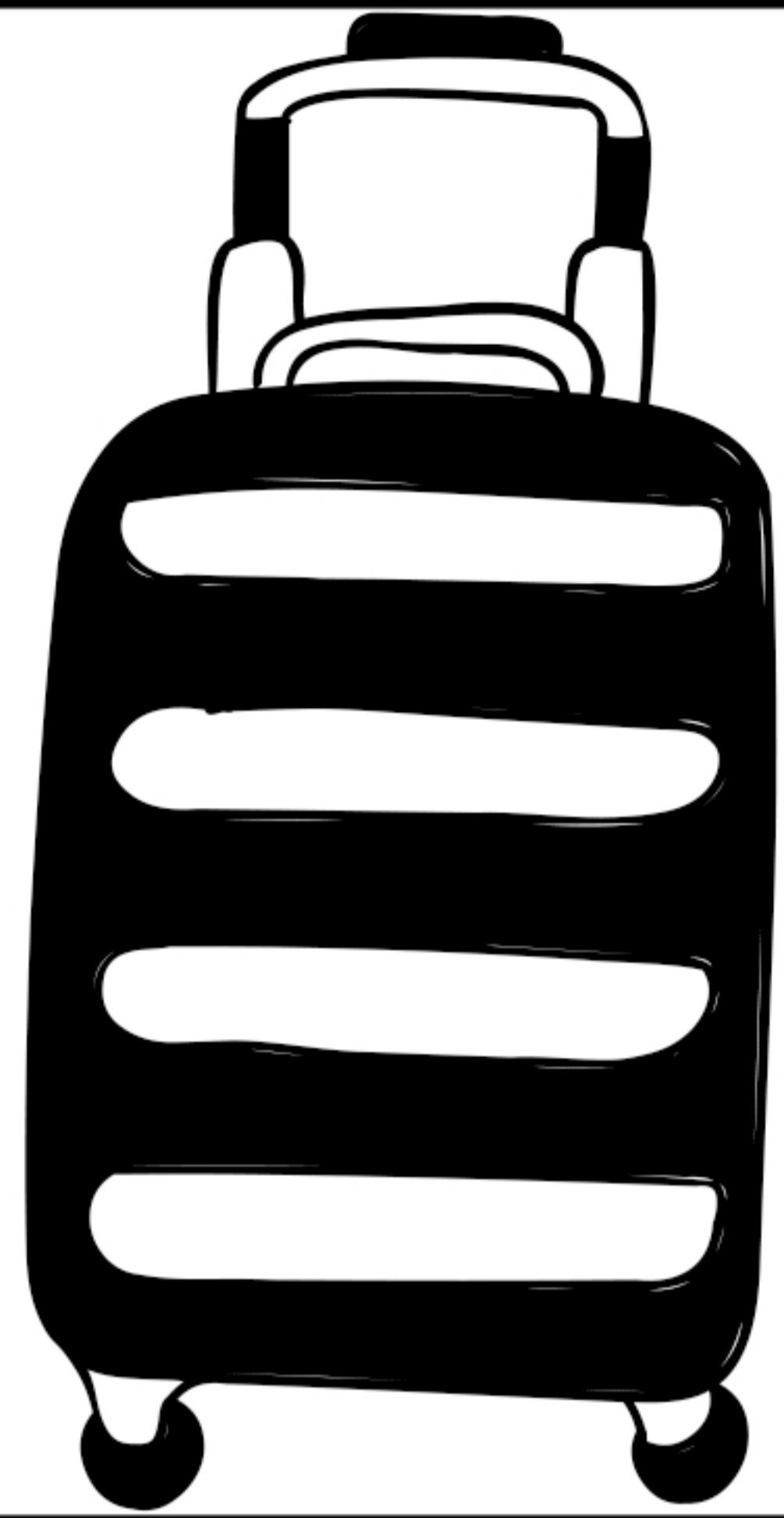

*en resväska*

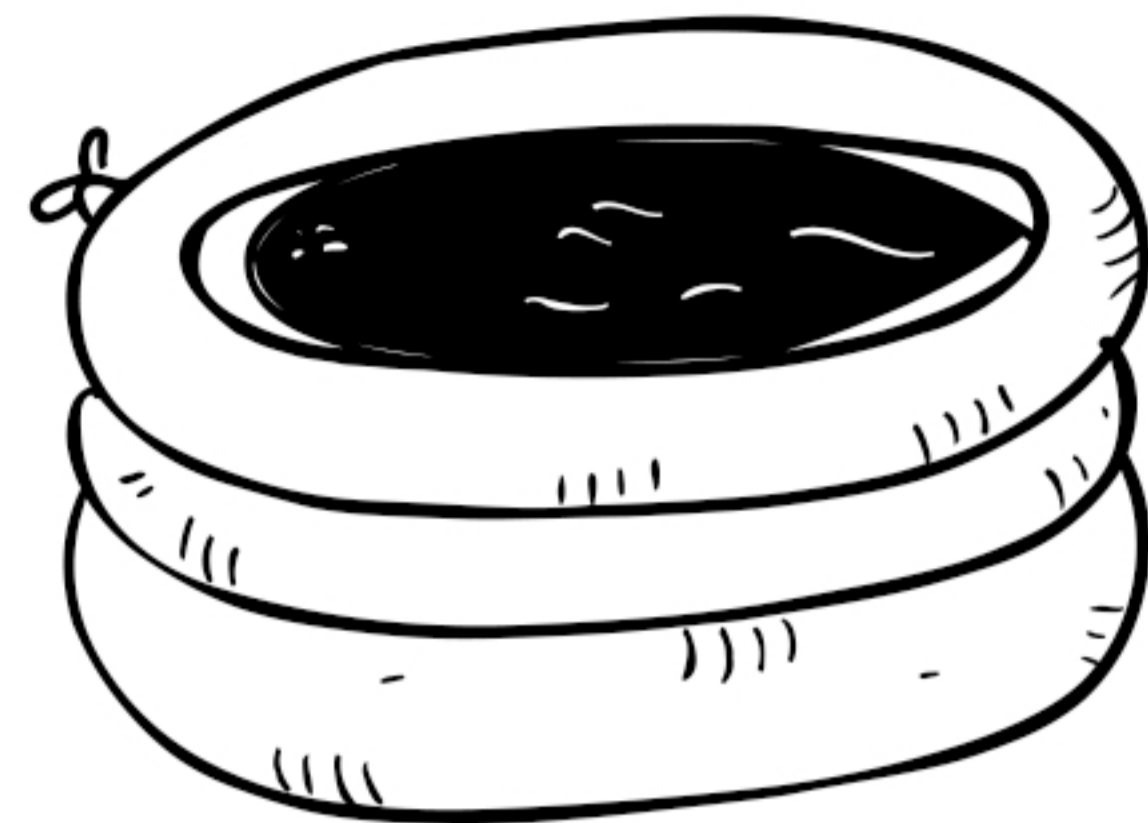

*en pool*



*ett par grodfötter*

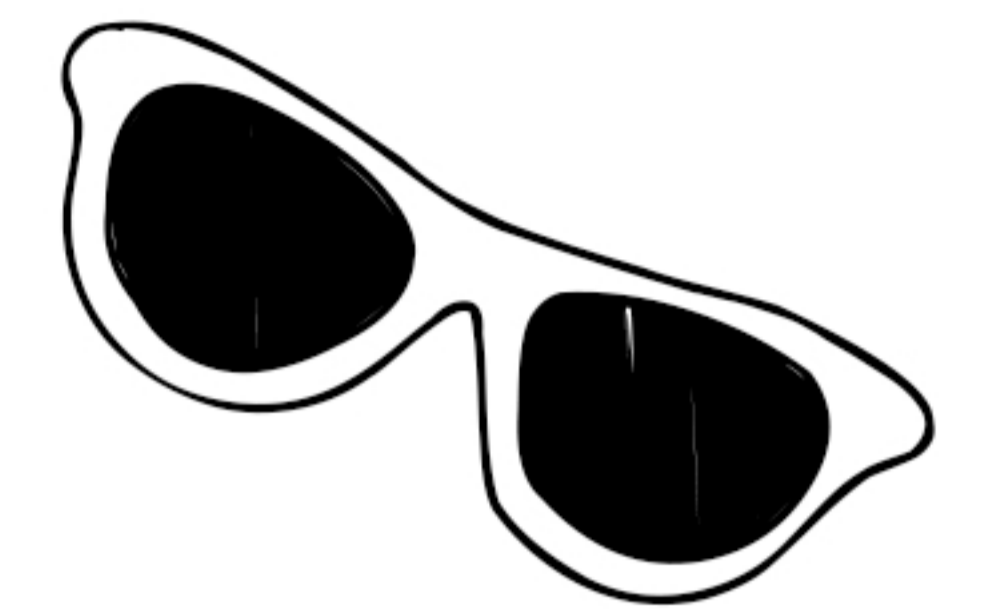

*ett par solglasögon*

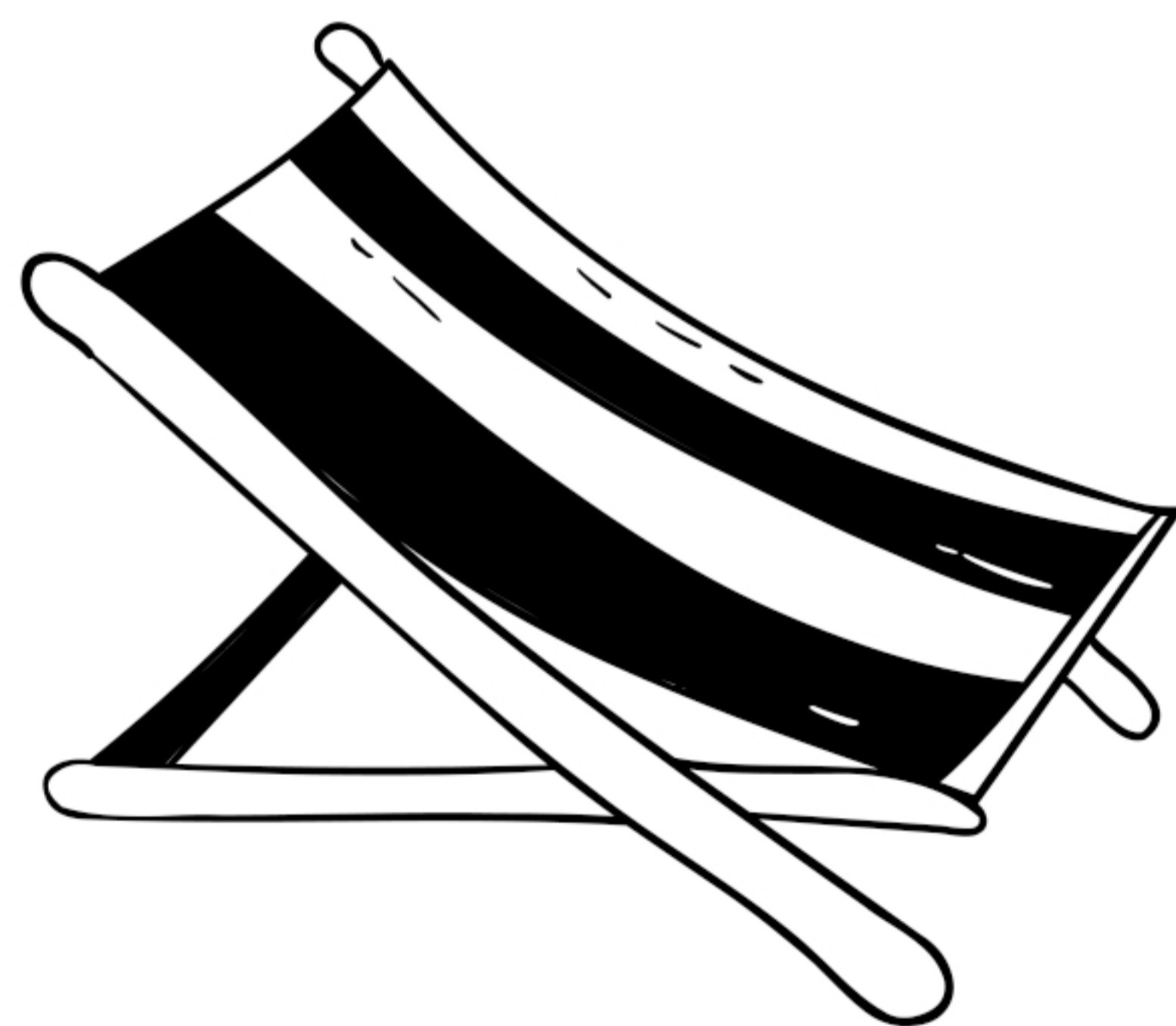

*en solstol*



*en strandväska*



*en glasstrut*

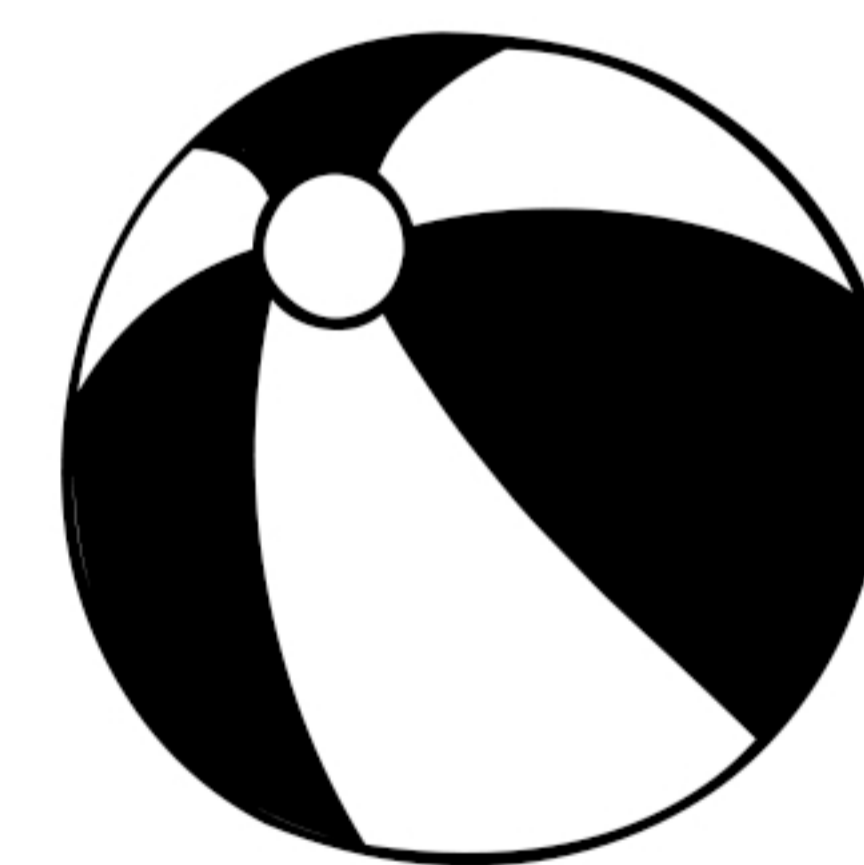

*en badboll*

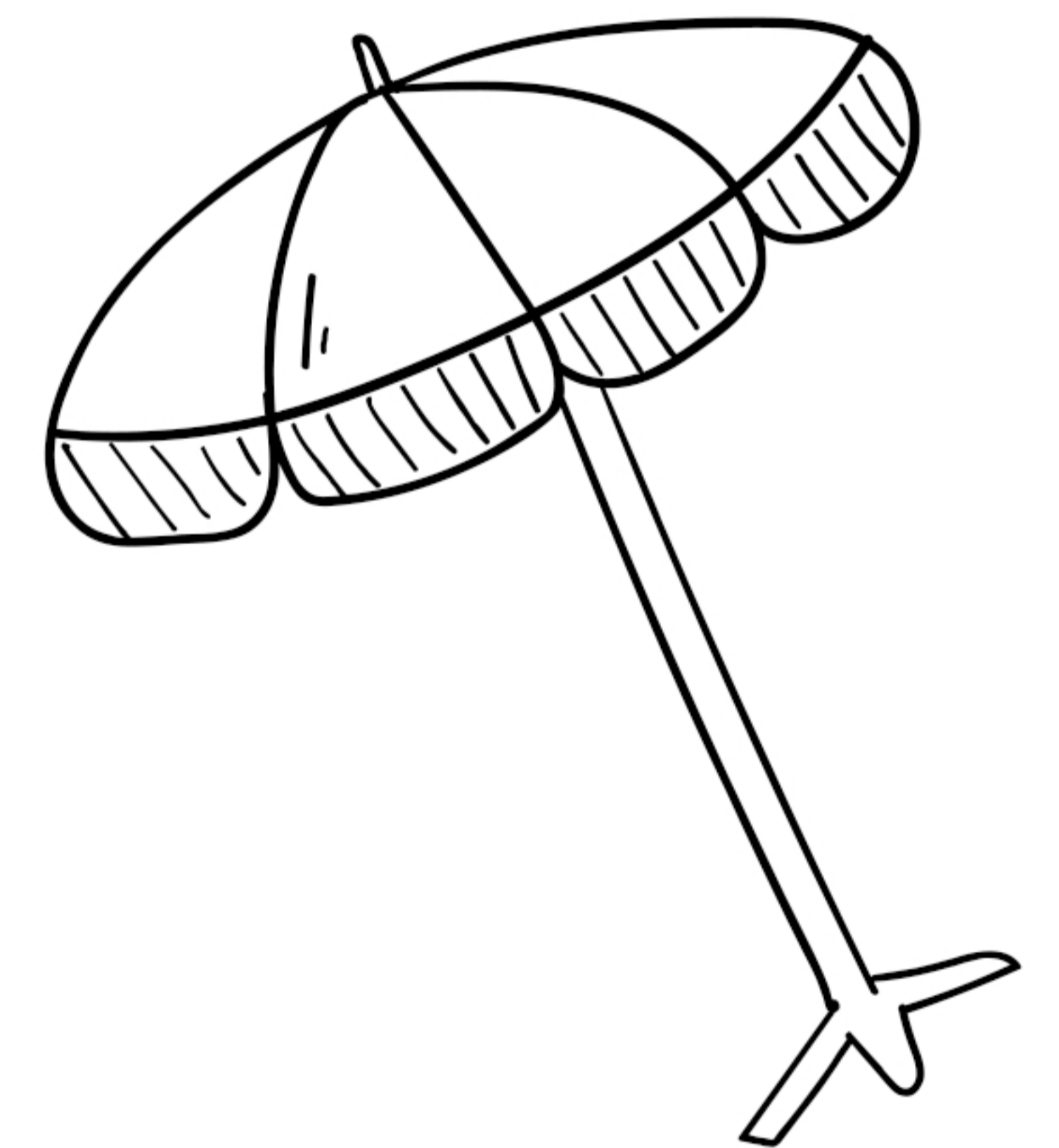

*ett parasoll*

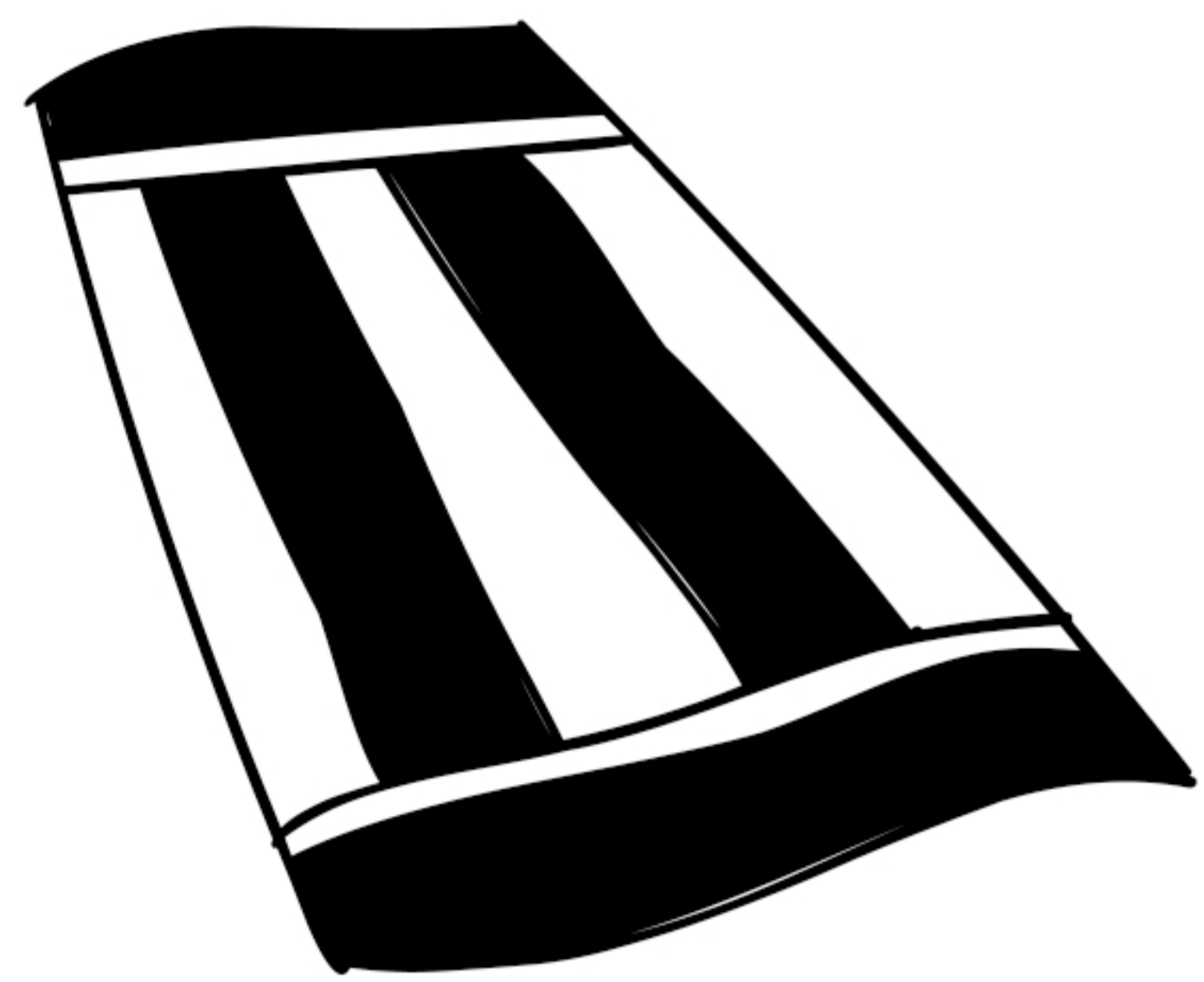

*ett badlakan*

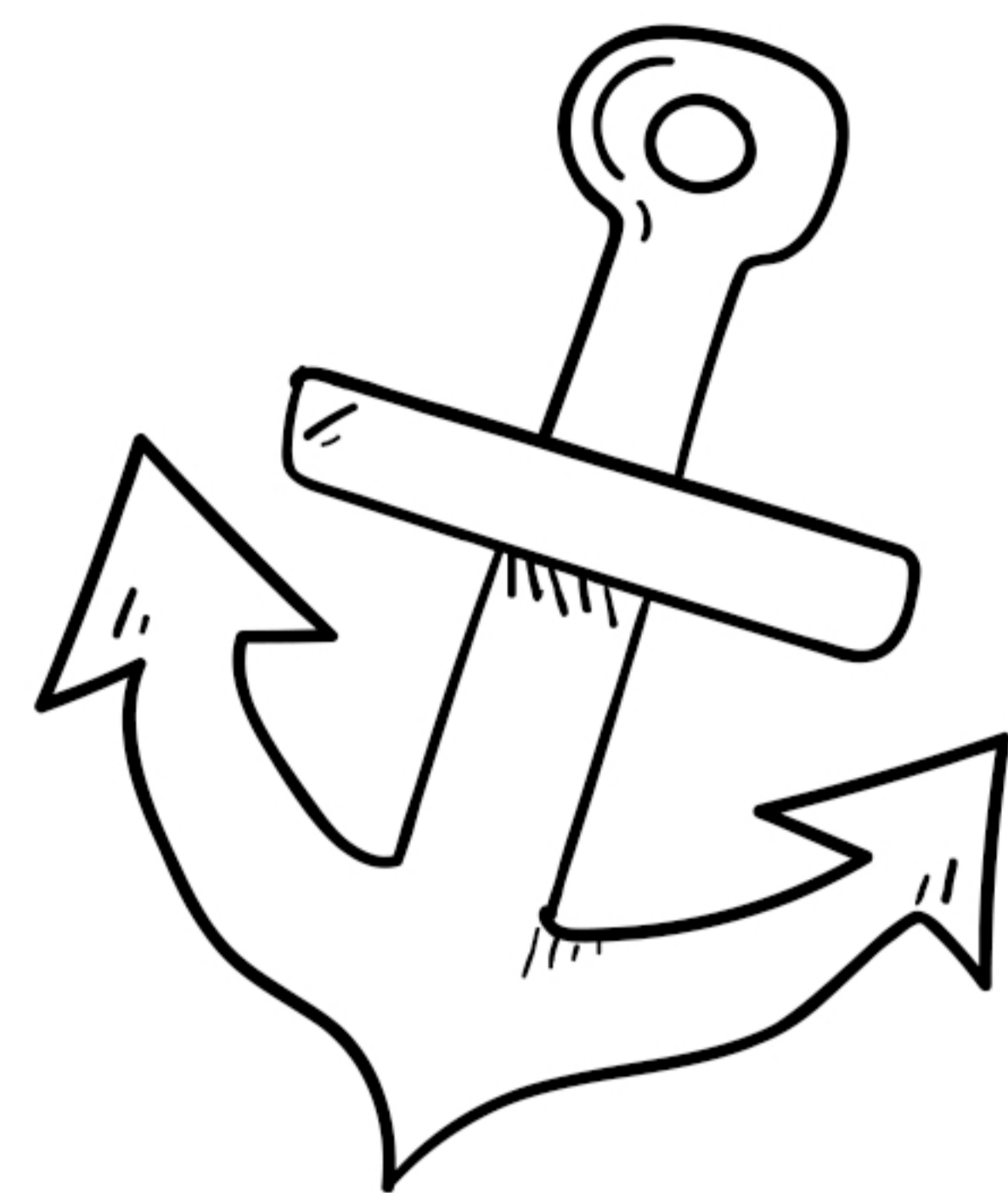

*ett ankare*

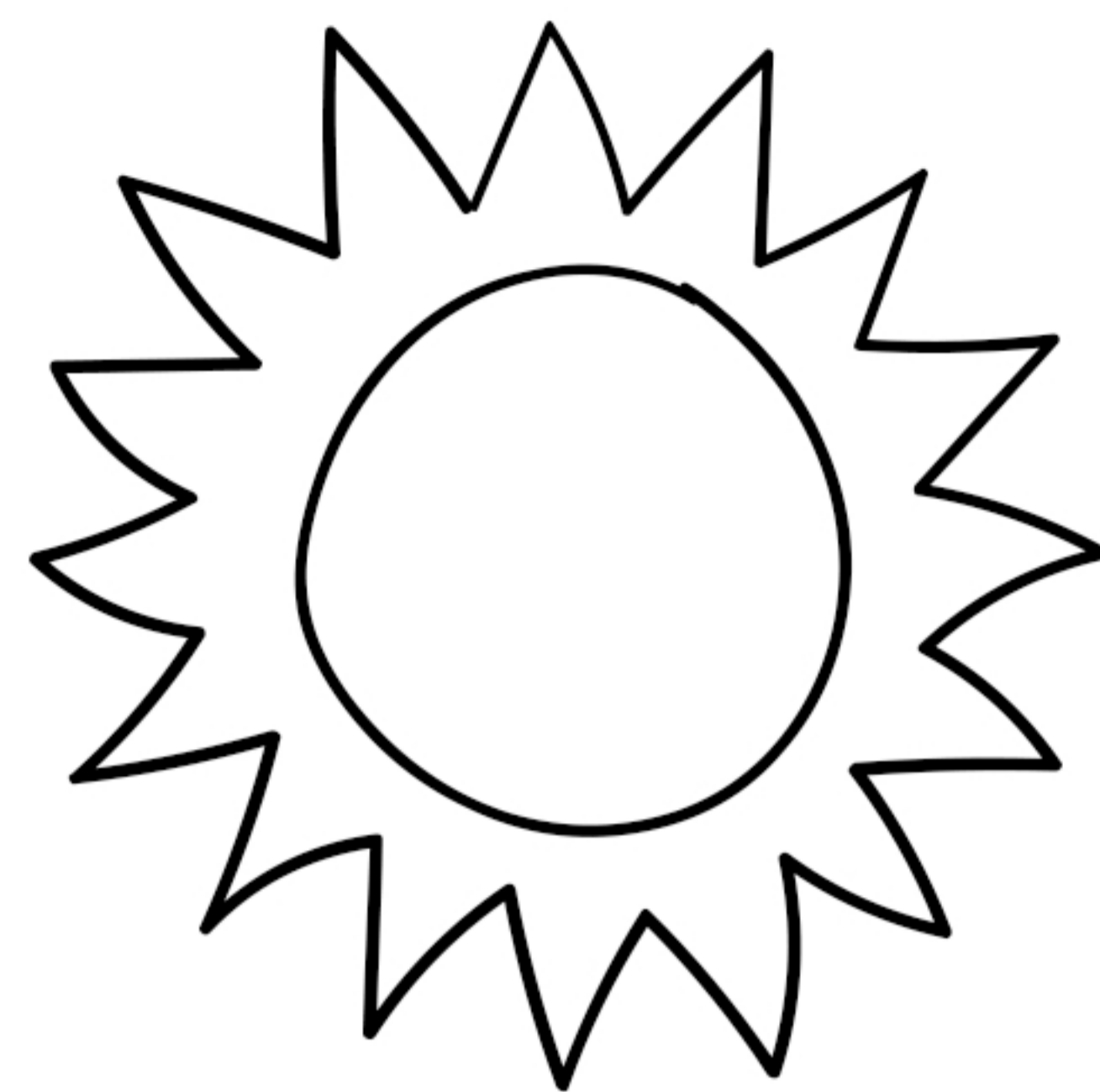

*en sol*



*en flaska handsprit*

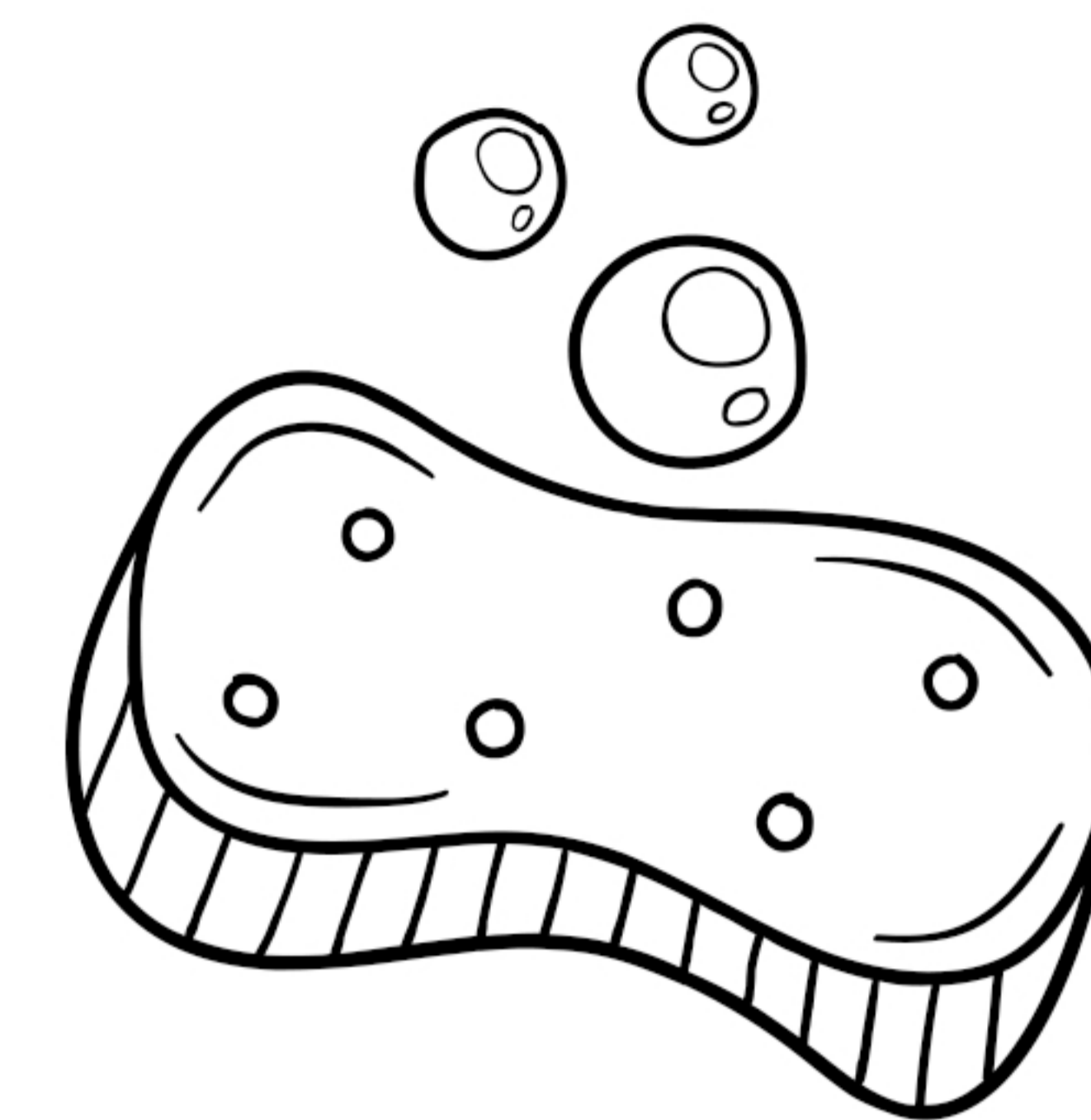

*en tvål*



*en spegel*

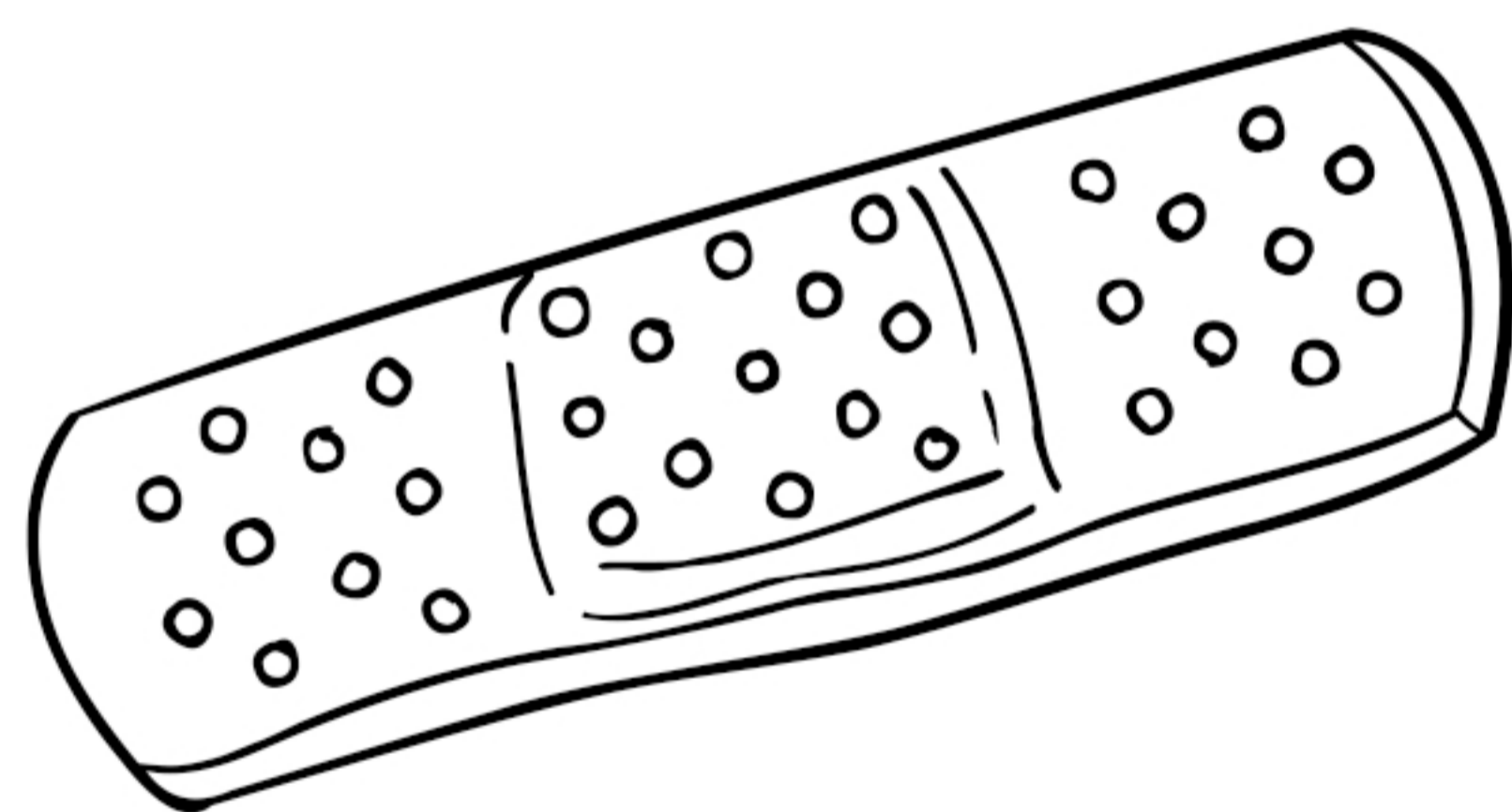

*ett plåster*

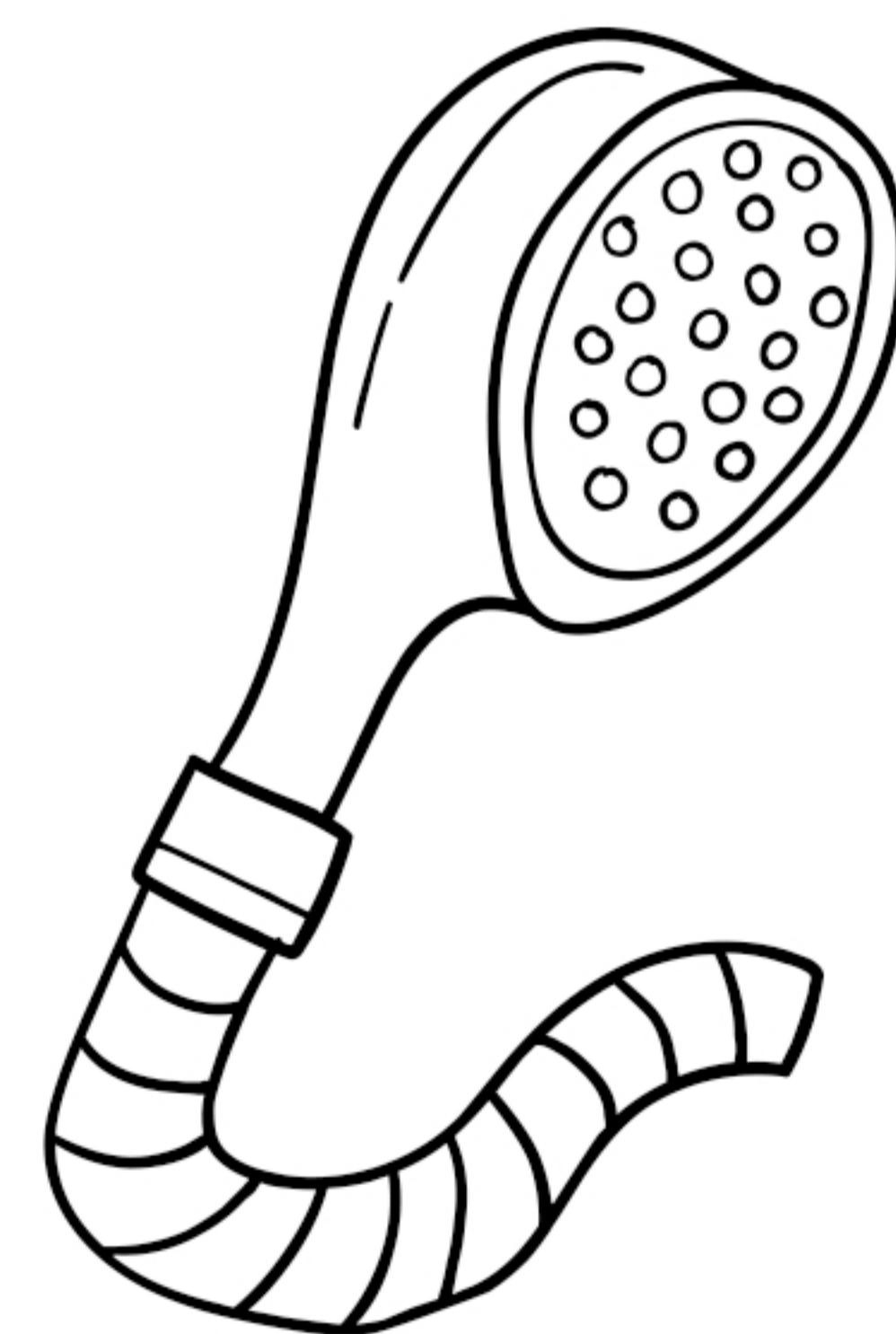

*en handdusch*

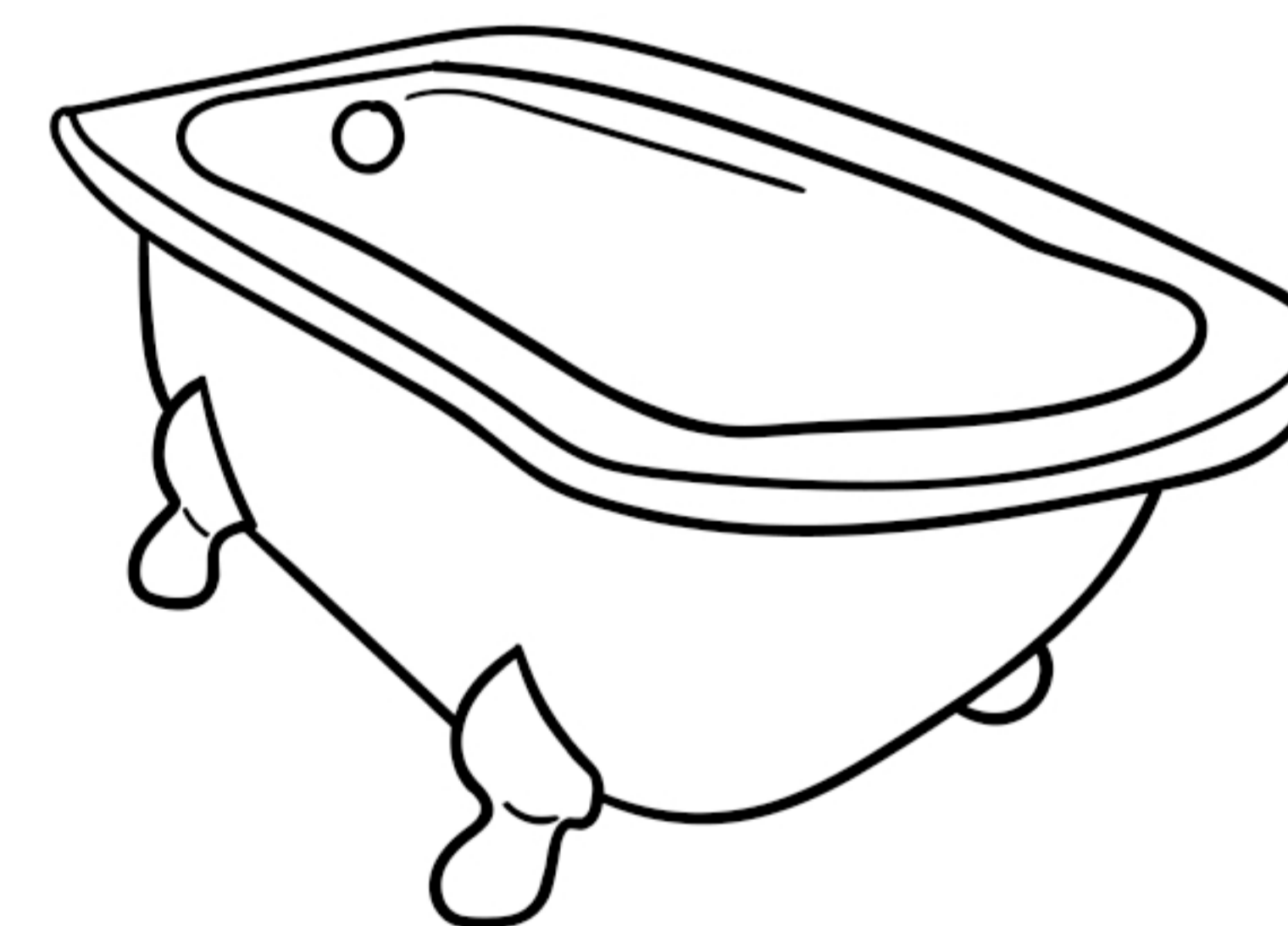

*ett badkar*

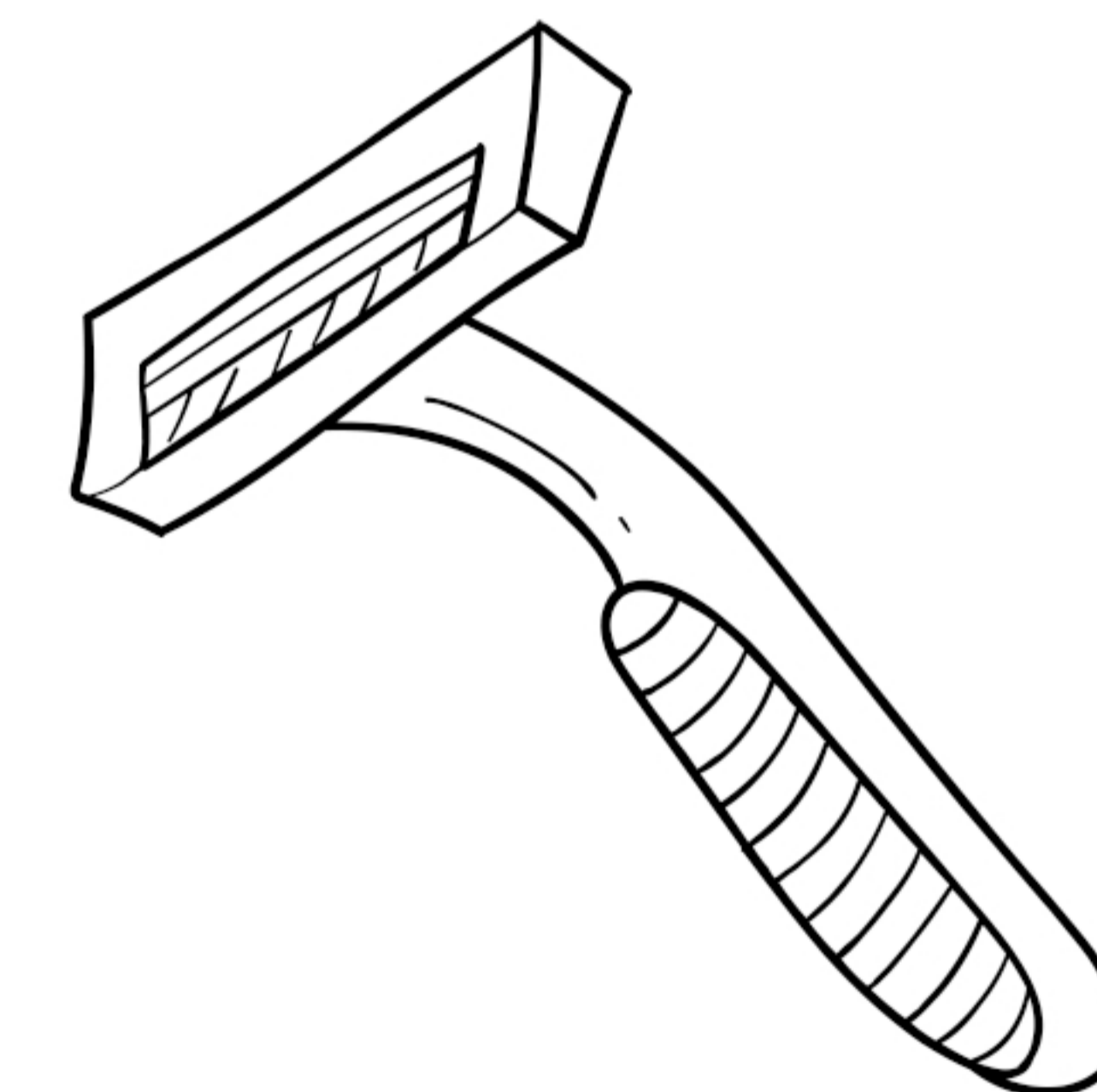

*en rakhyvel*

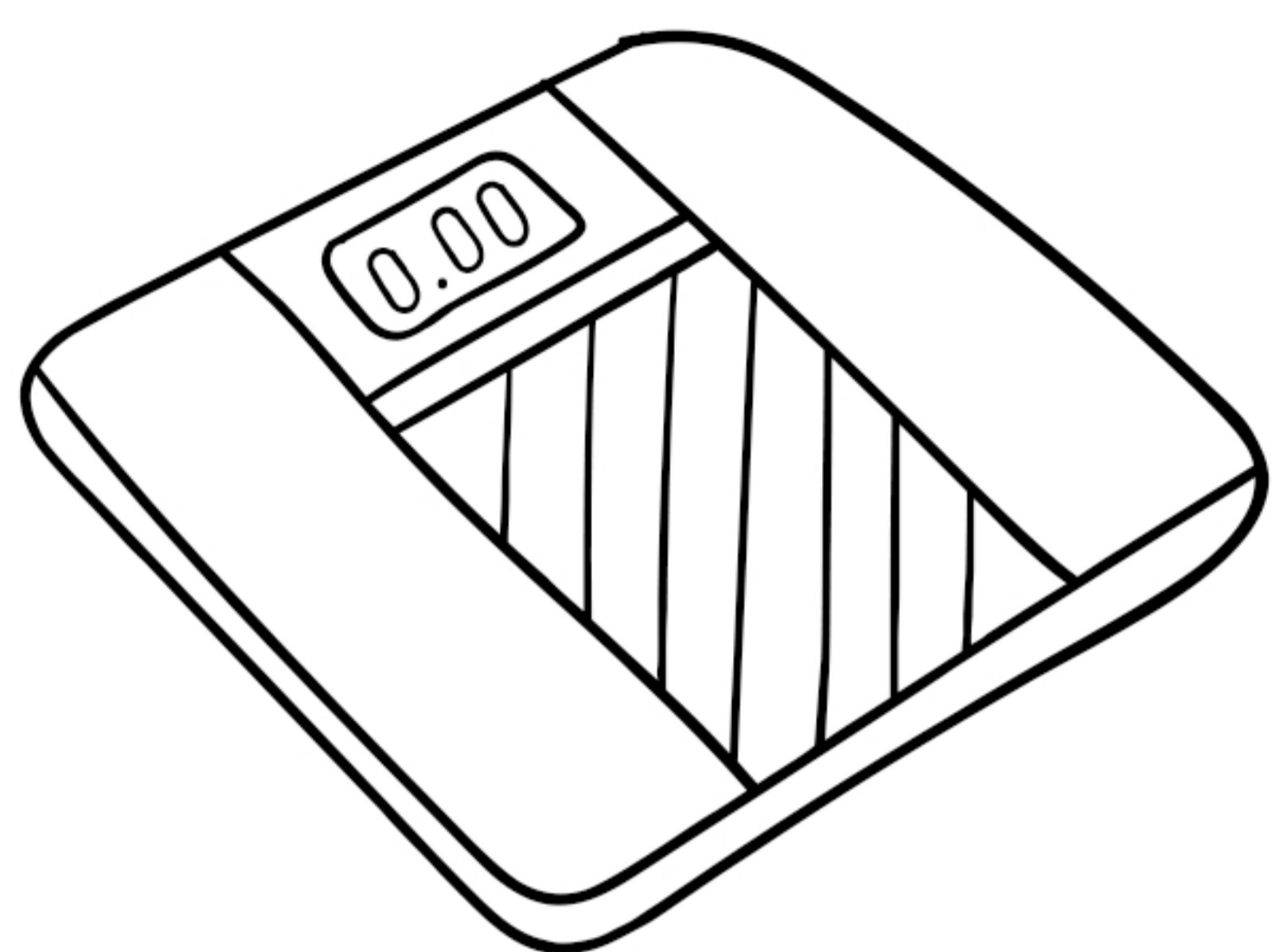

*en våg*

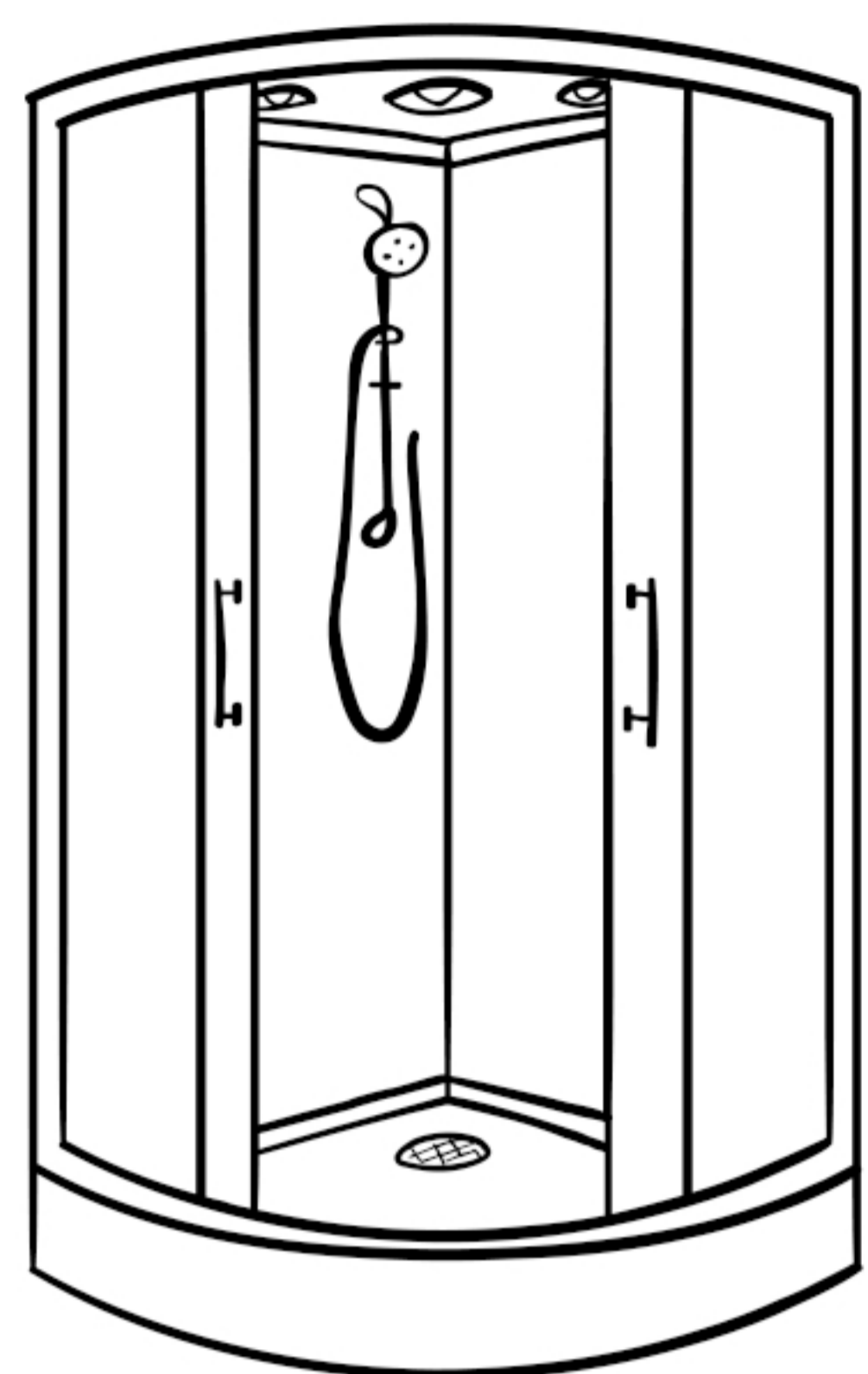

*en dusch*

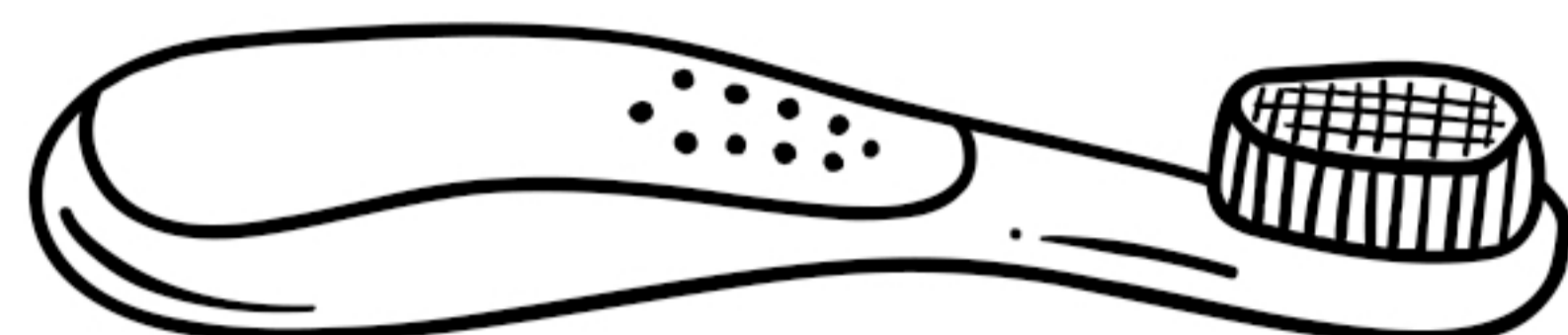

*en tandborste*

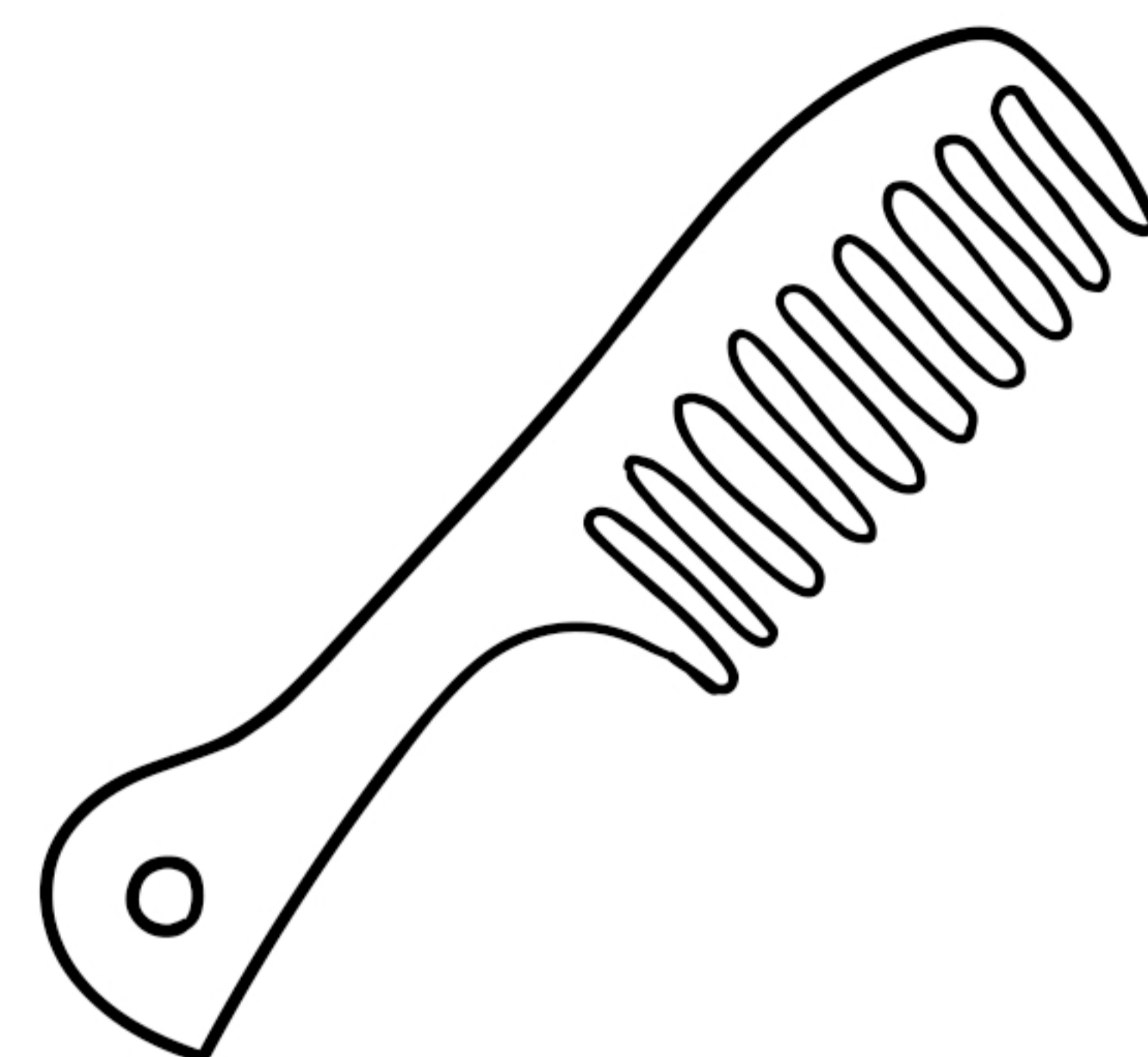

*en kam*

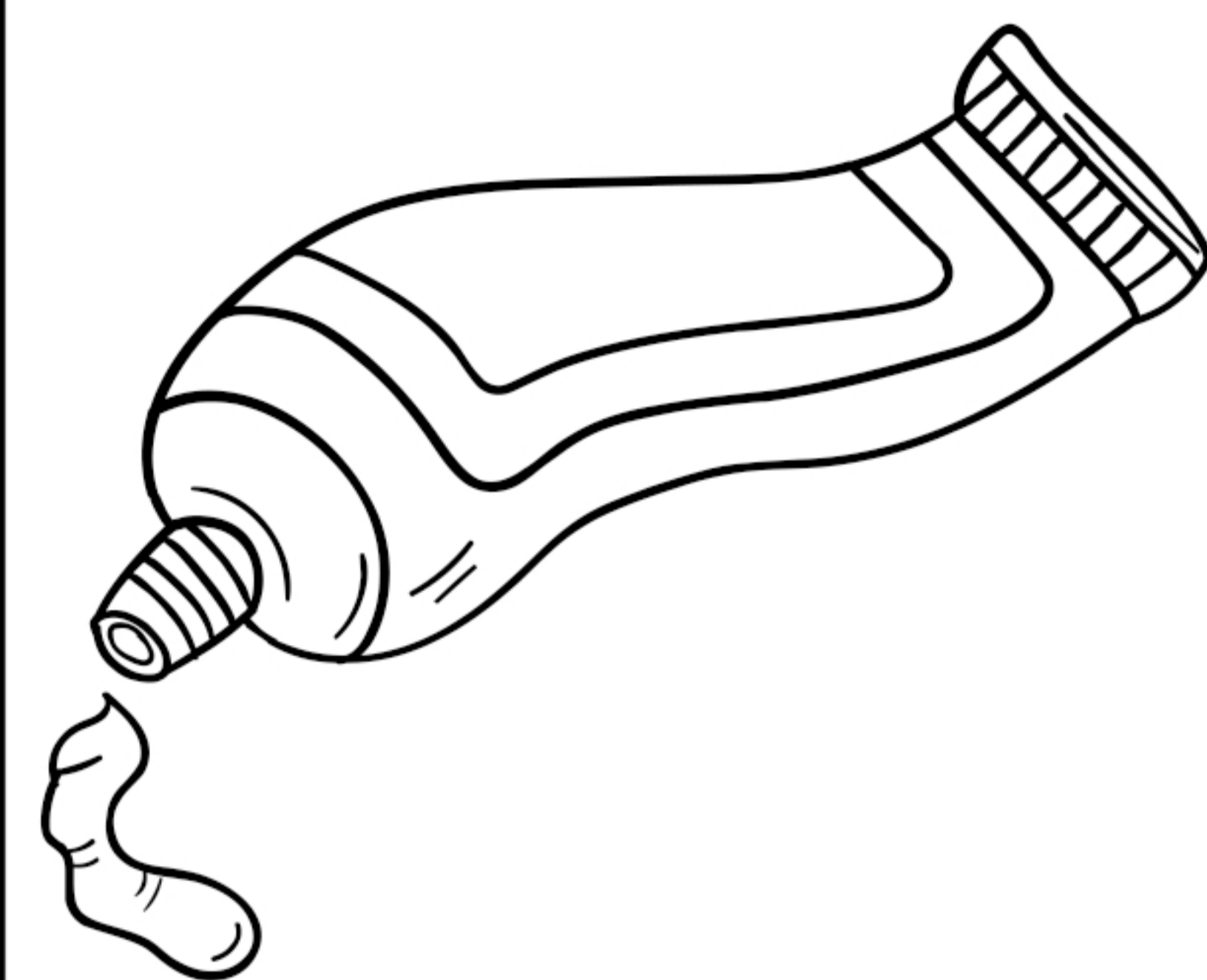

*en tandkrämstüb*



*en hårtork*

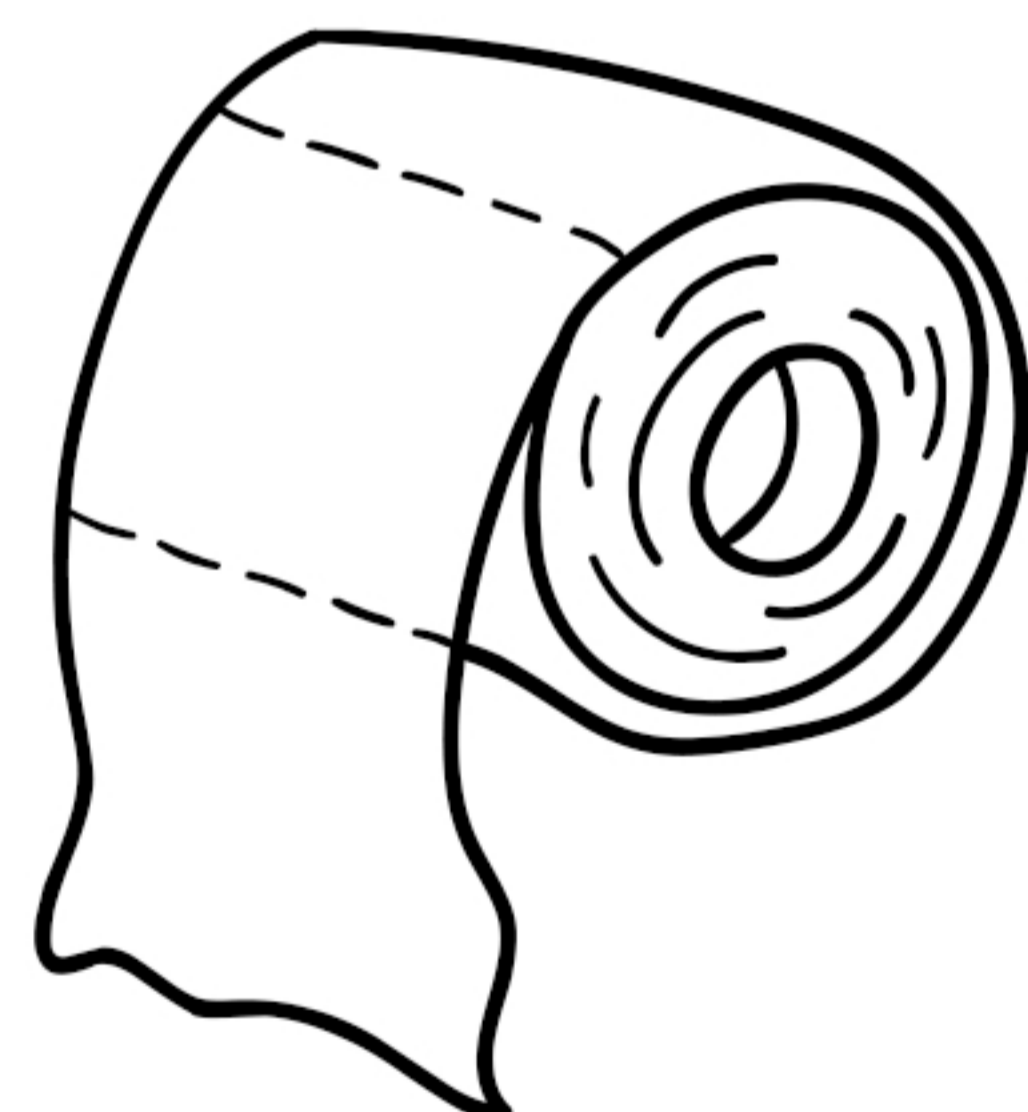

*toalettpapper*

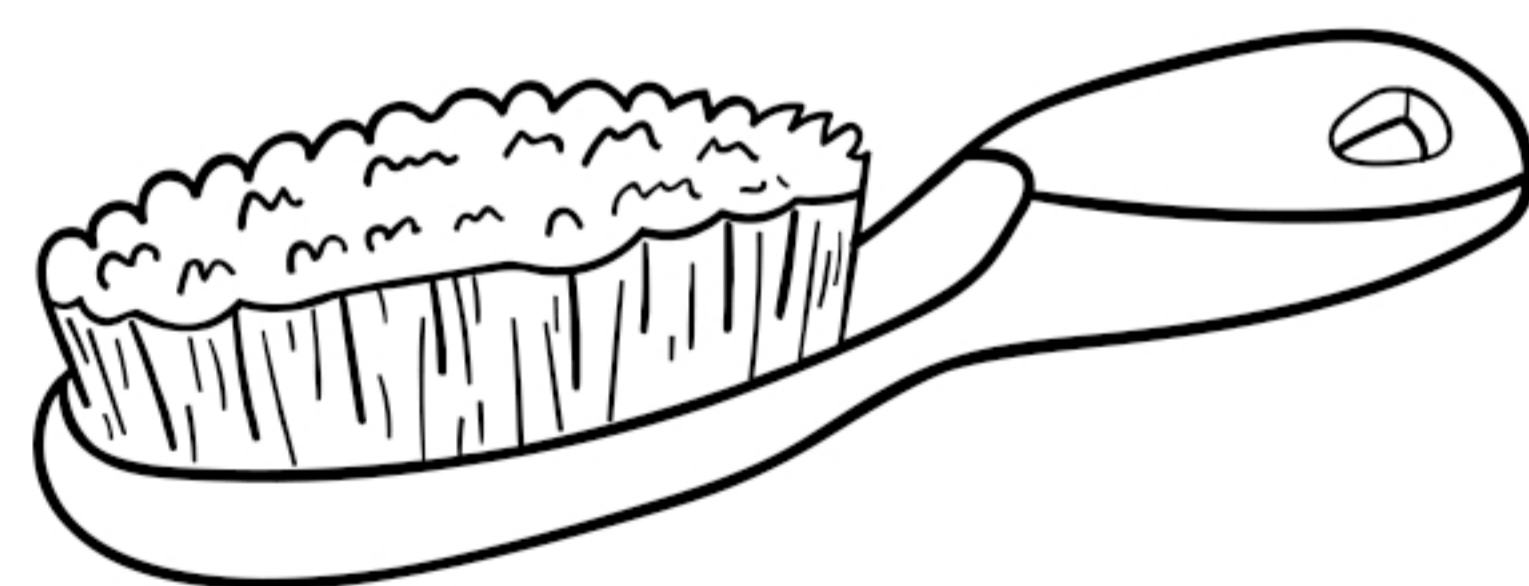

*en hårborste*

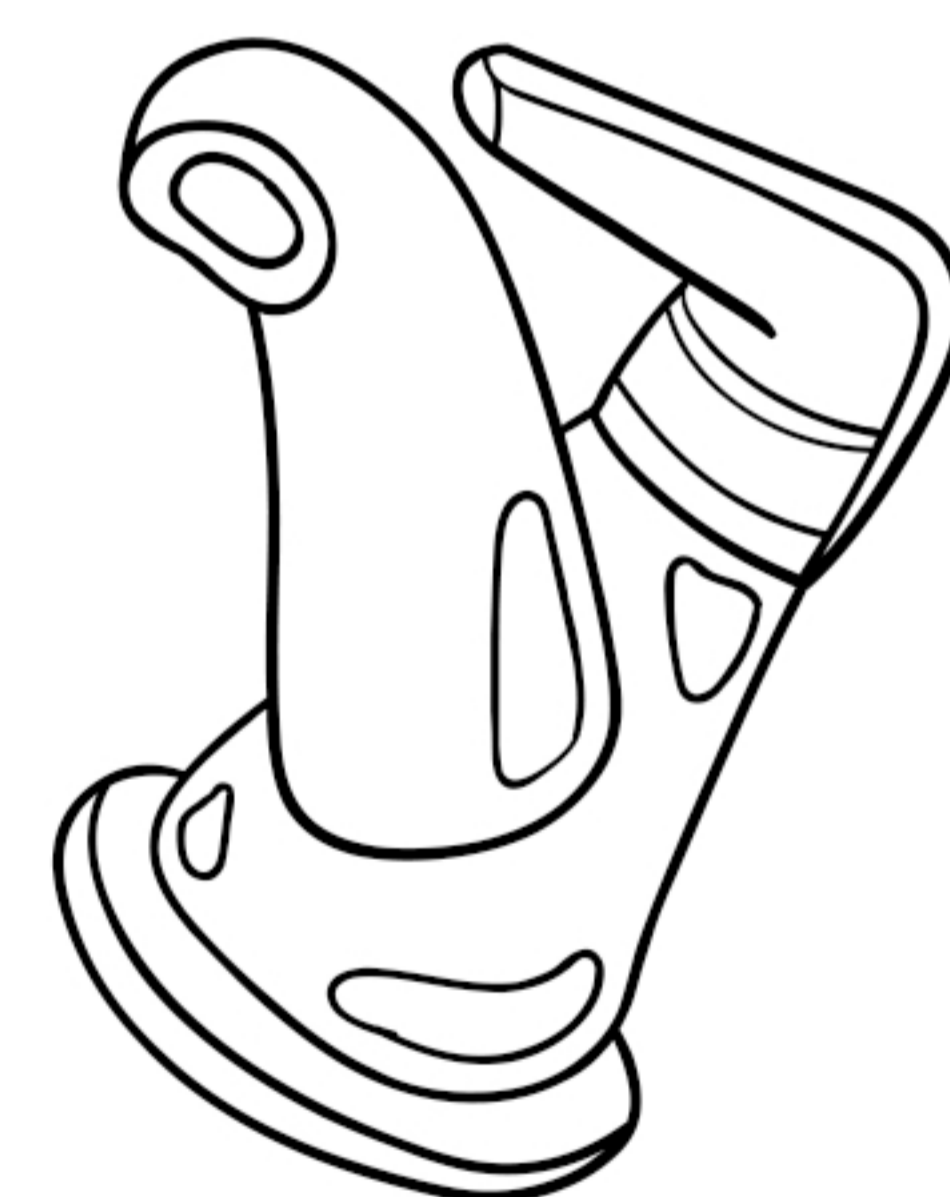

*en vattenkran*

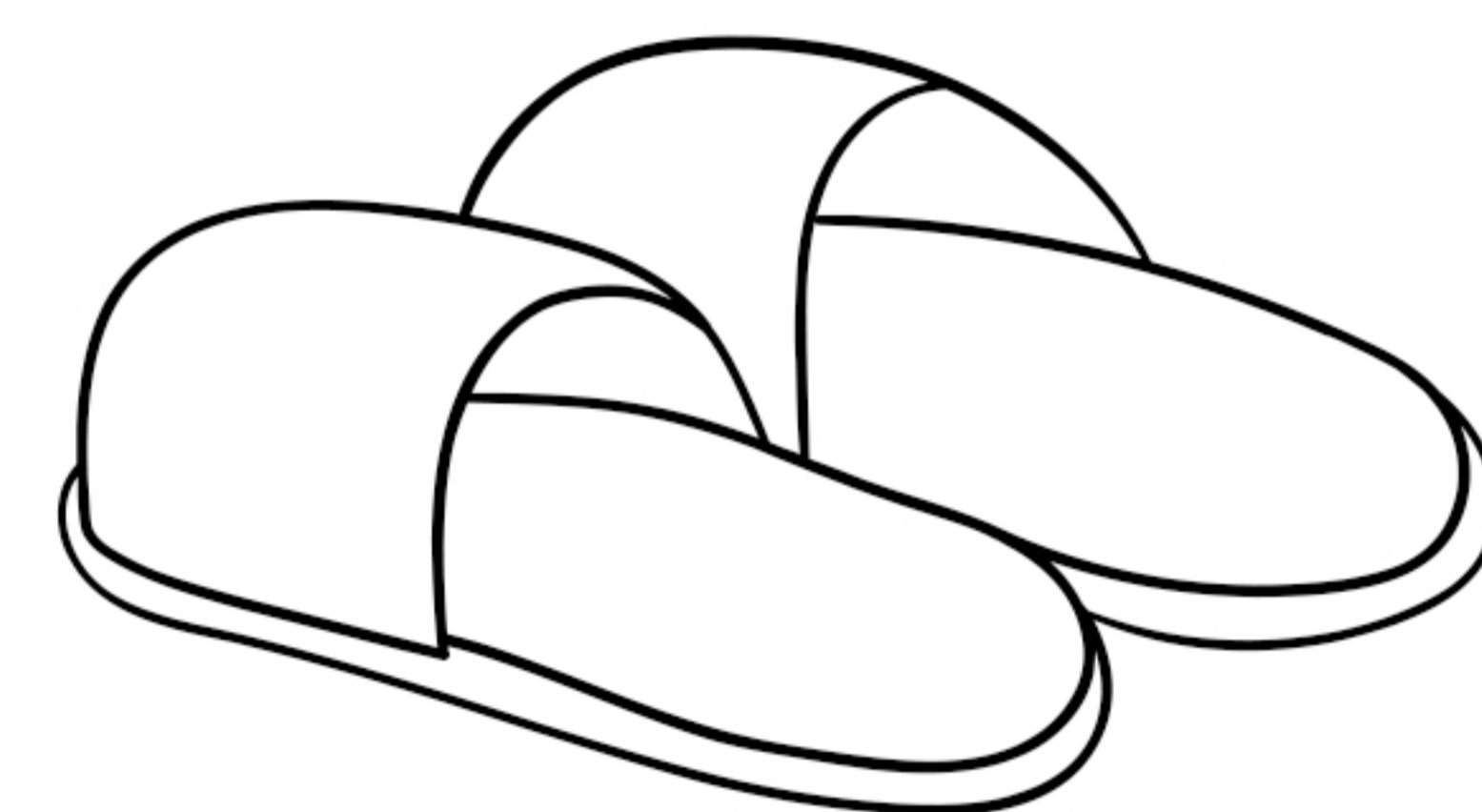

*ett par tofflor*



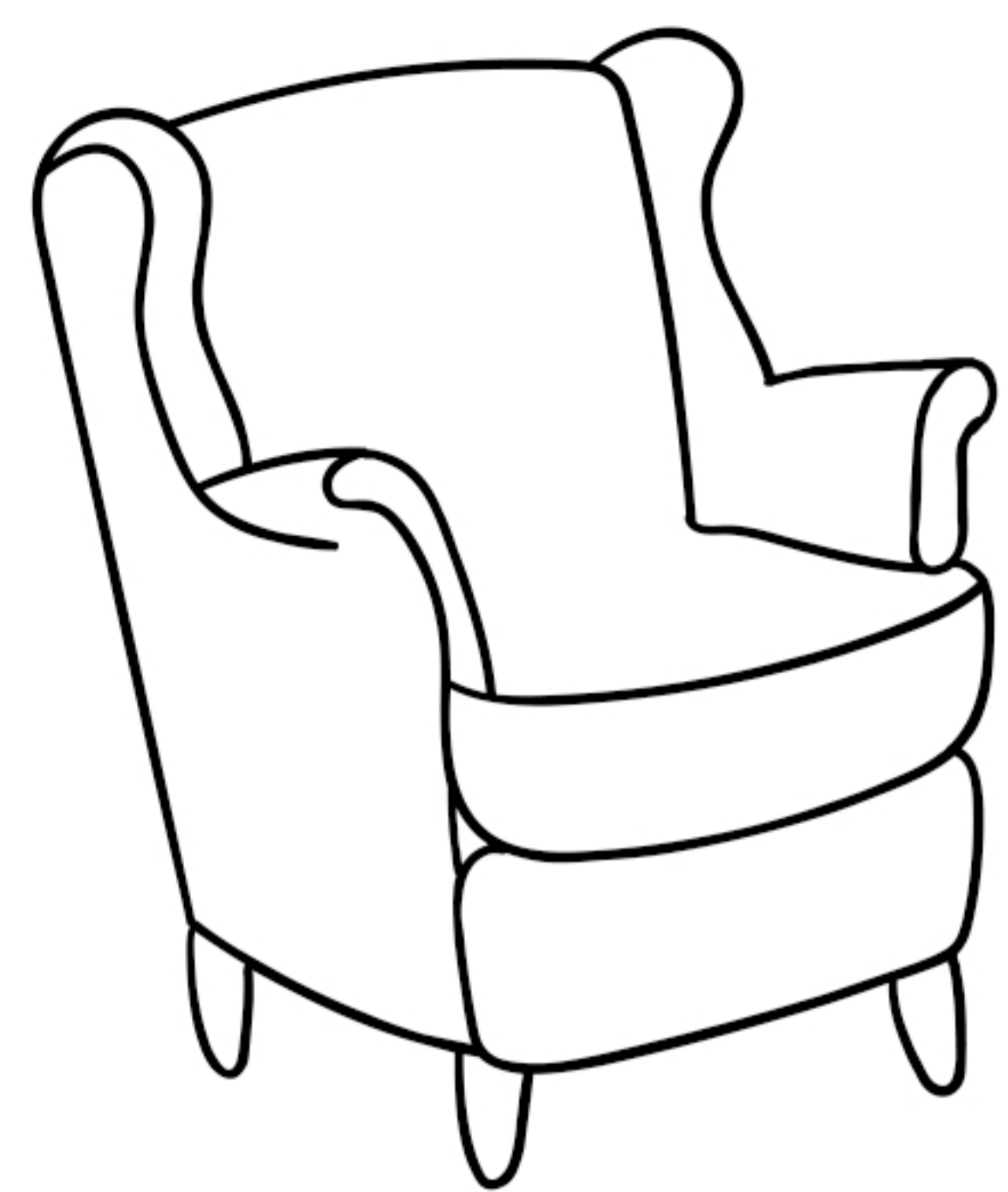

*en fåtölj*

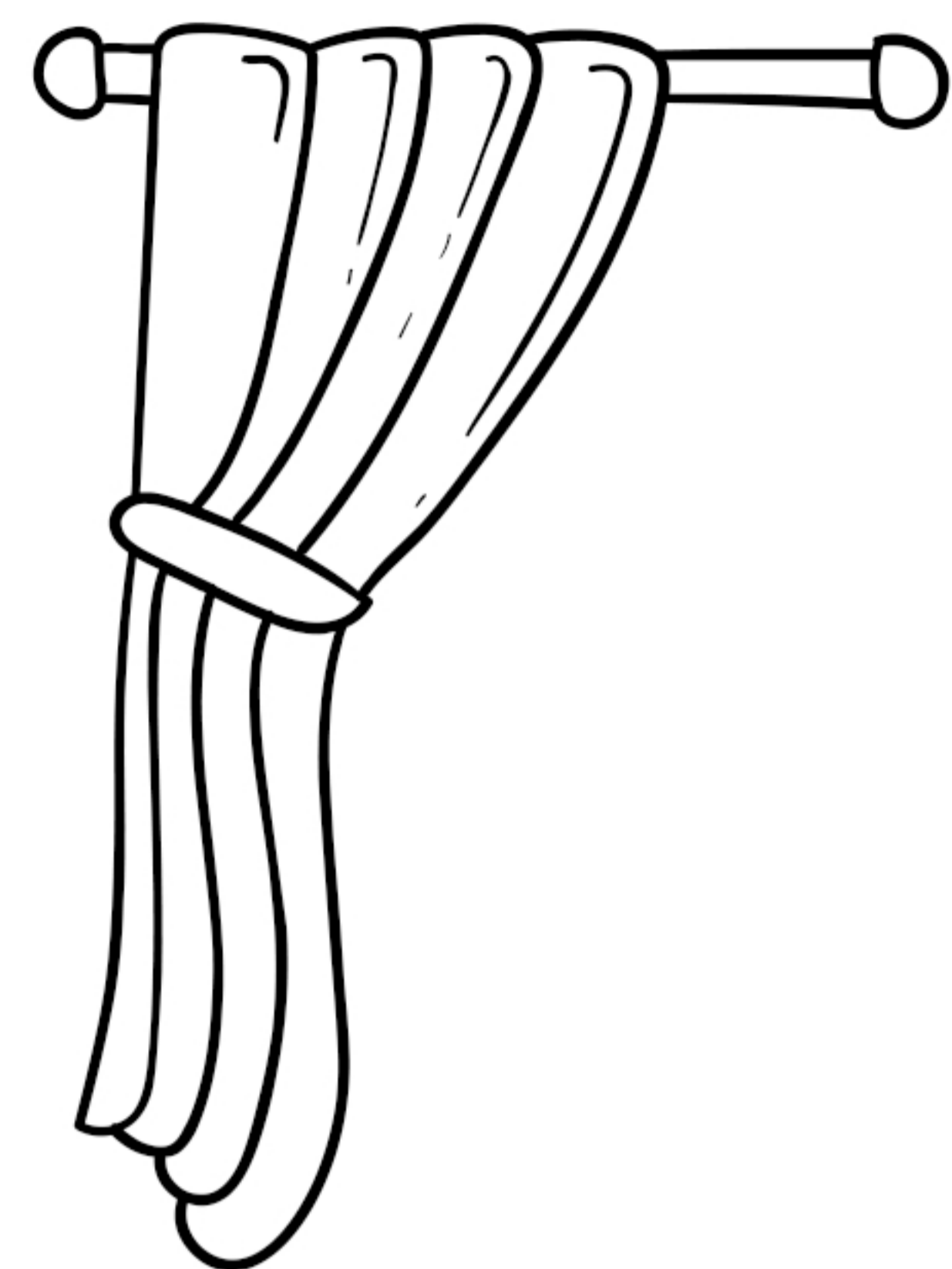

*en gardin*

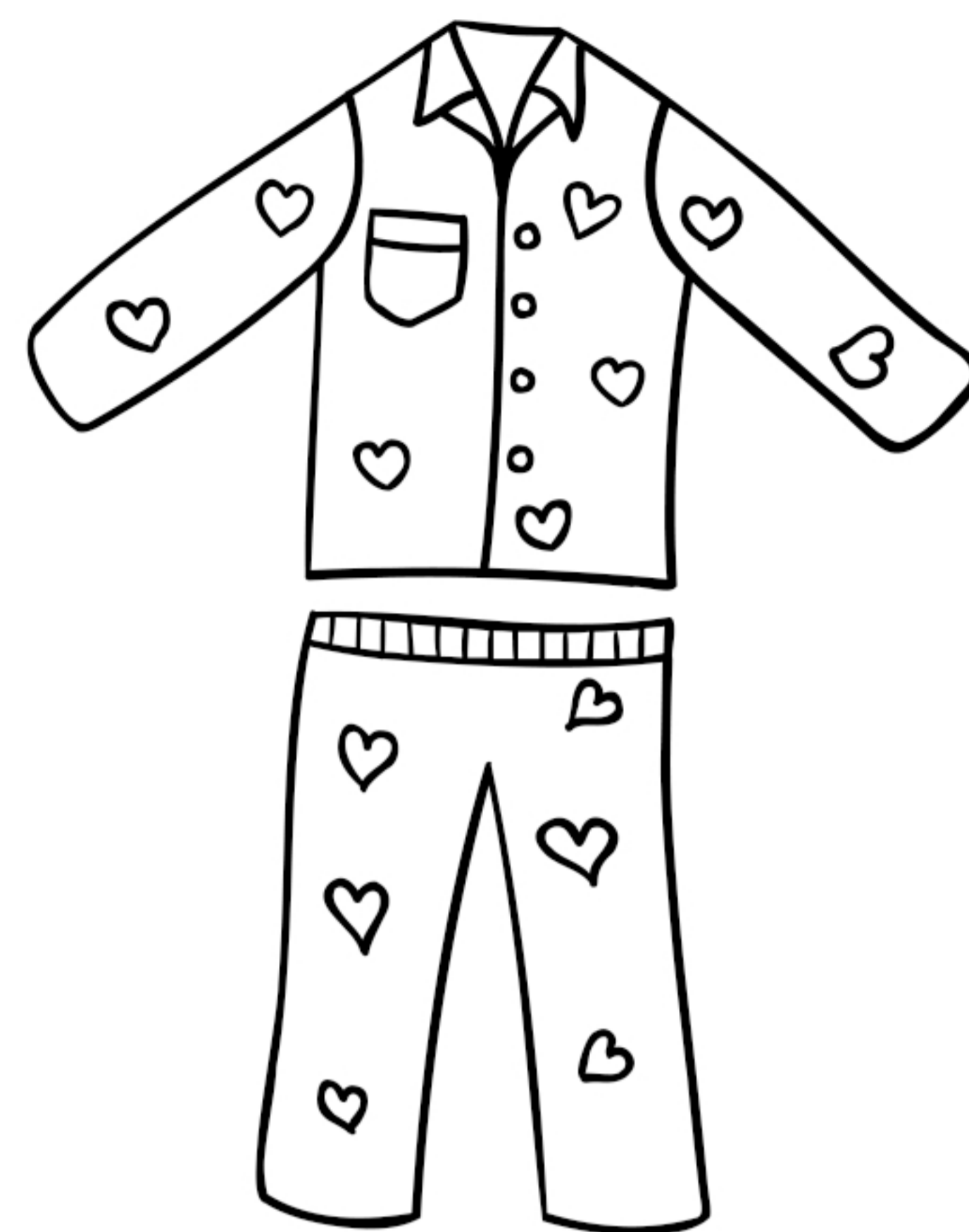

*en pyjamas*

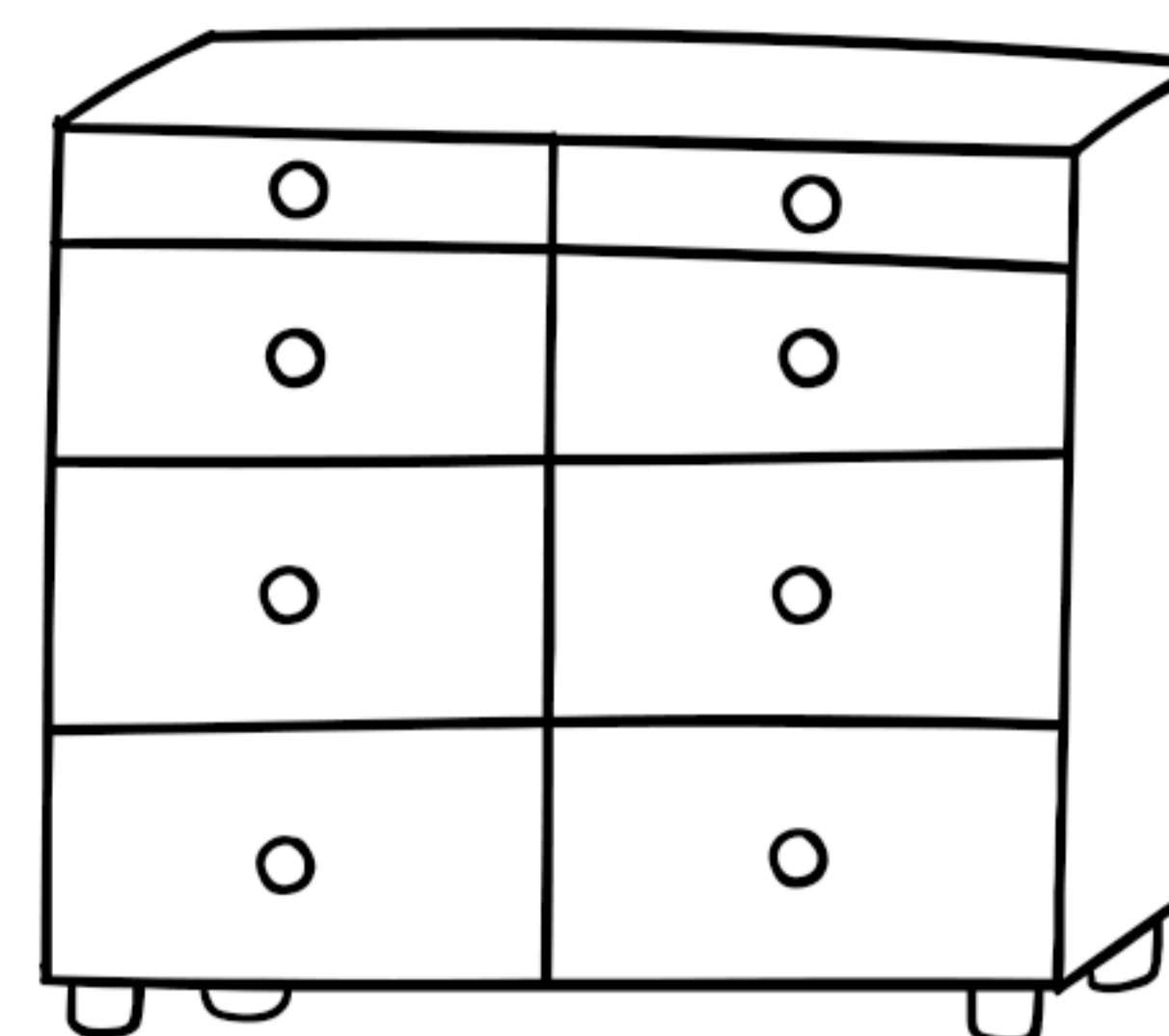

*en byrå*

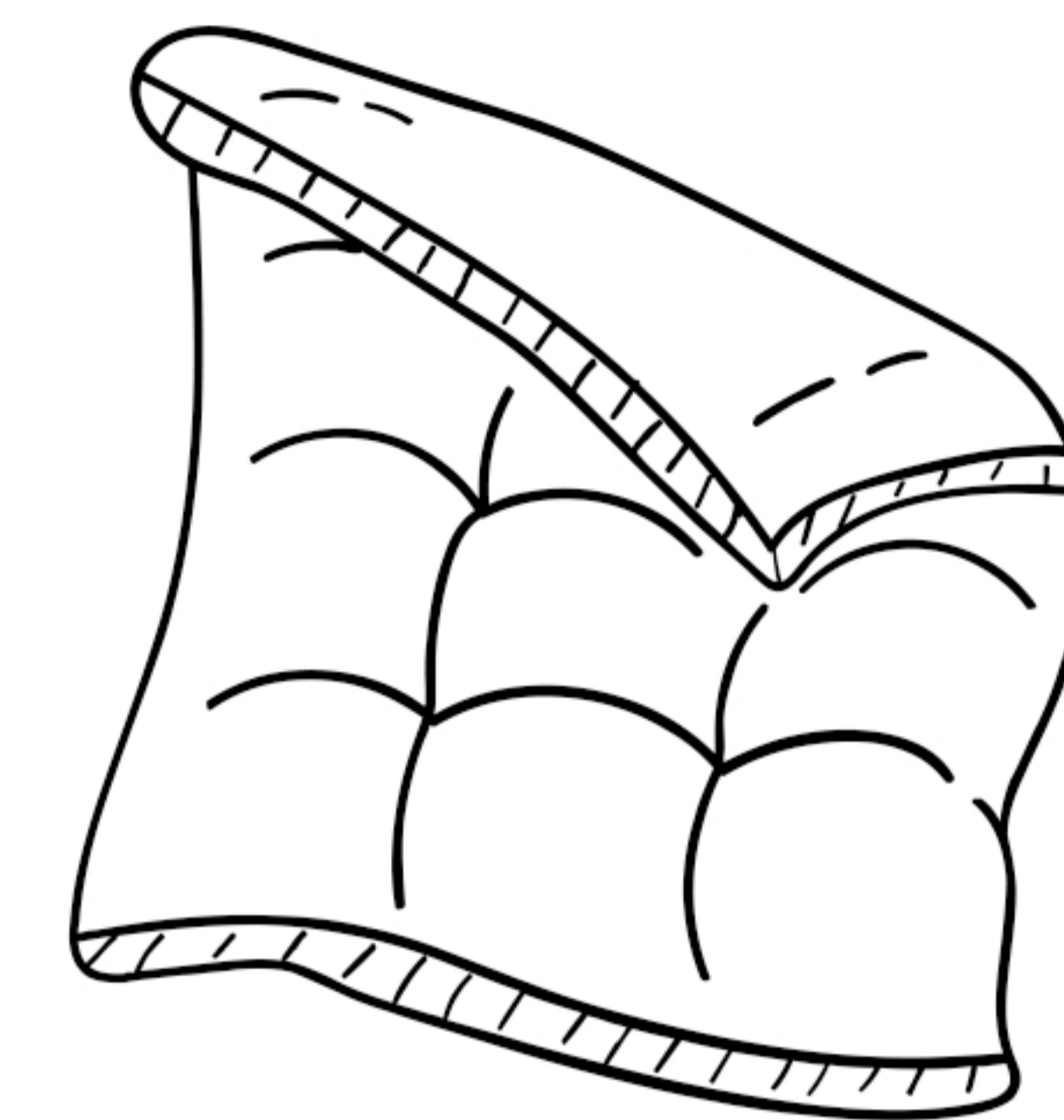

*ett täcke*

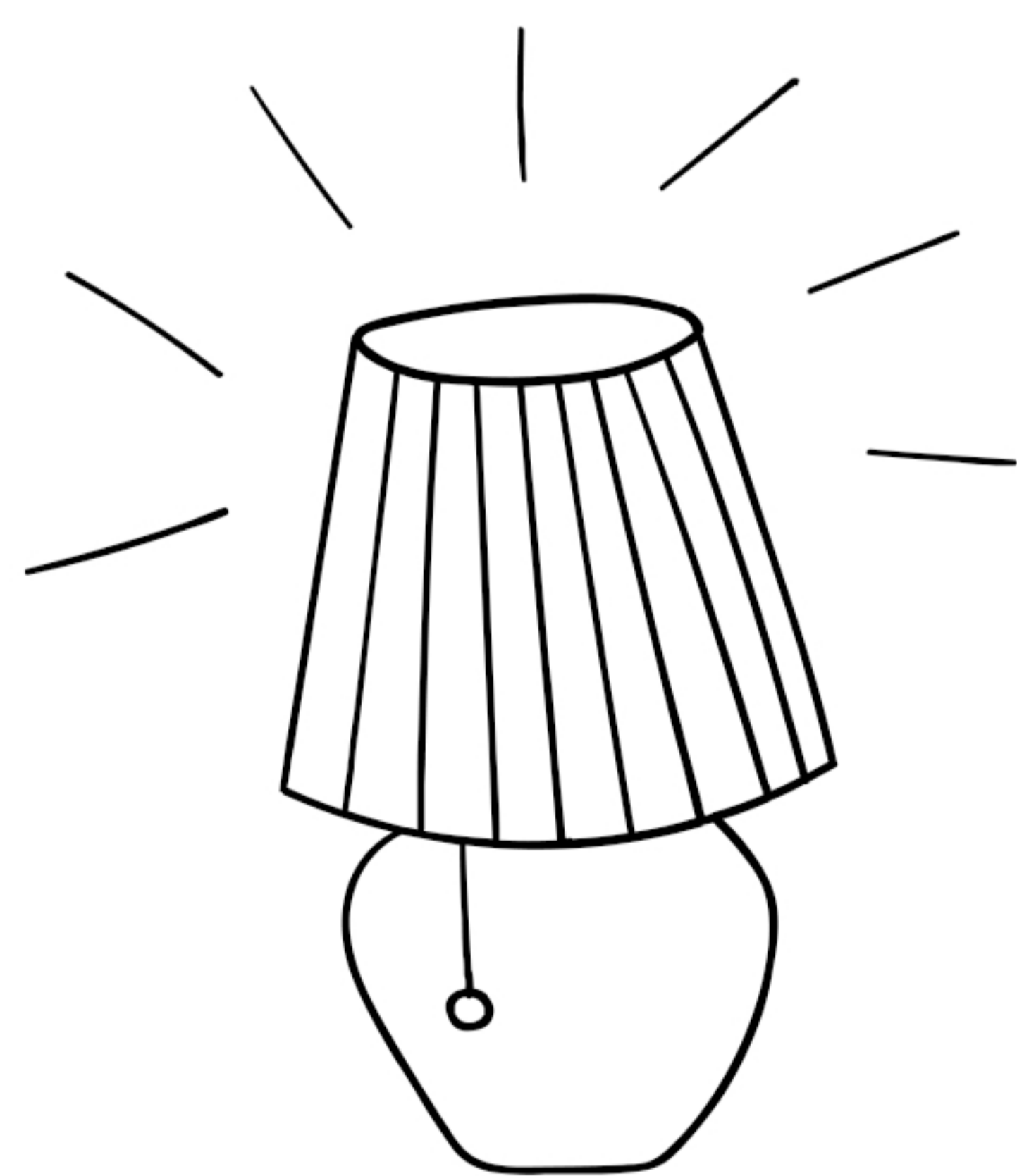

*en sänglampa*

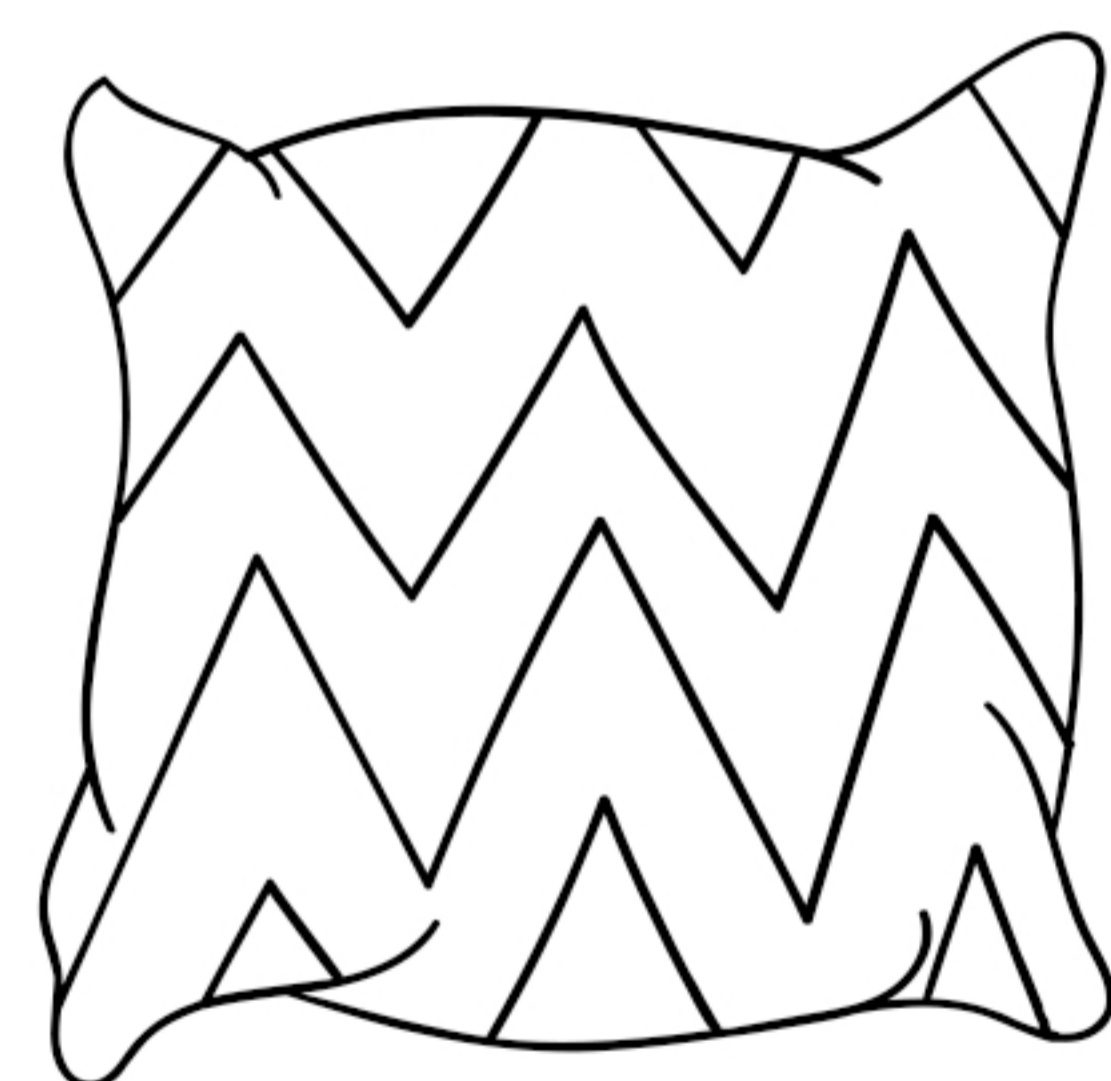

*en kudde*



*en sänghylla*



*en toalett*

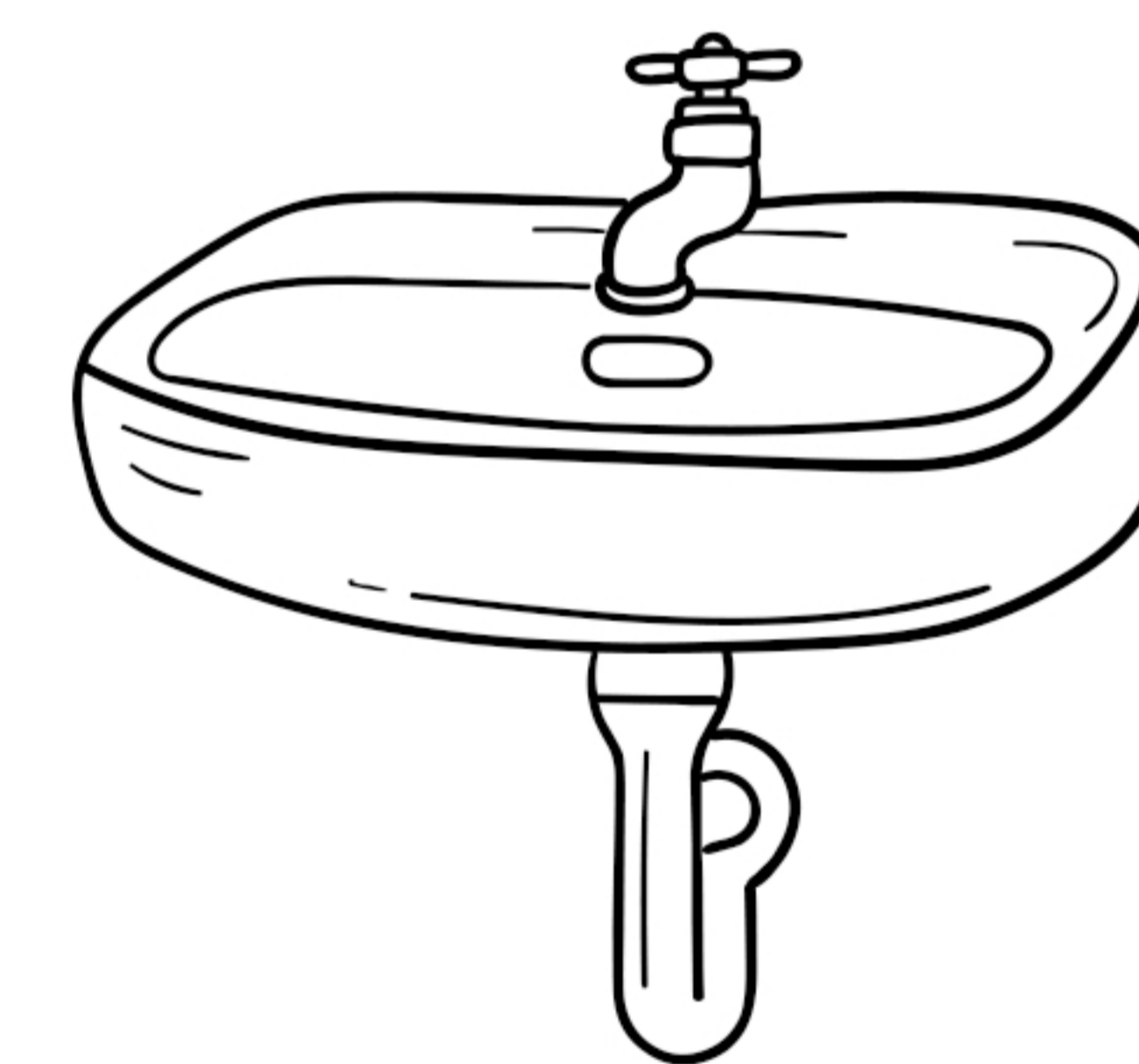

*ett handfat*

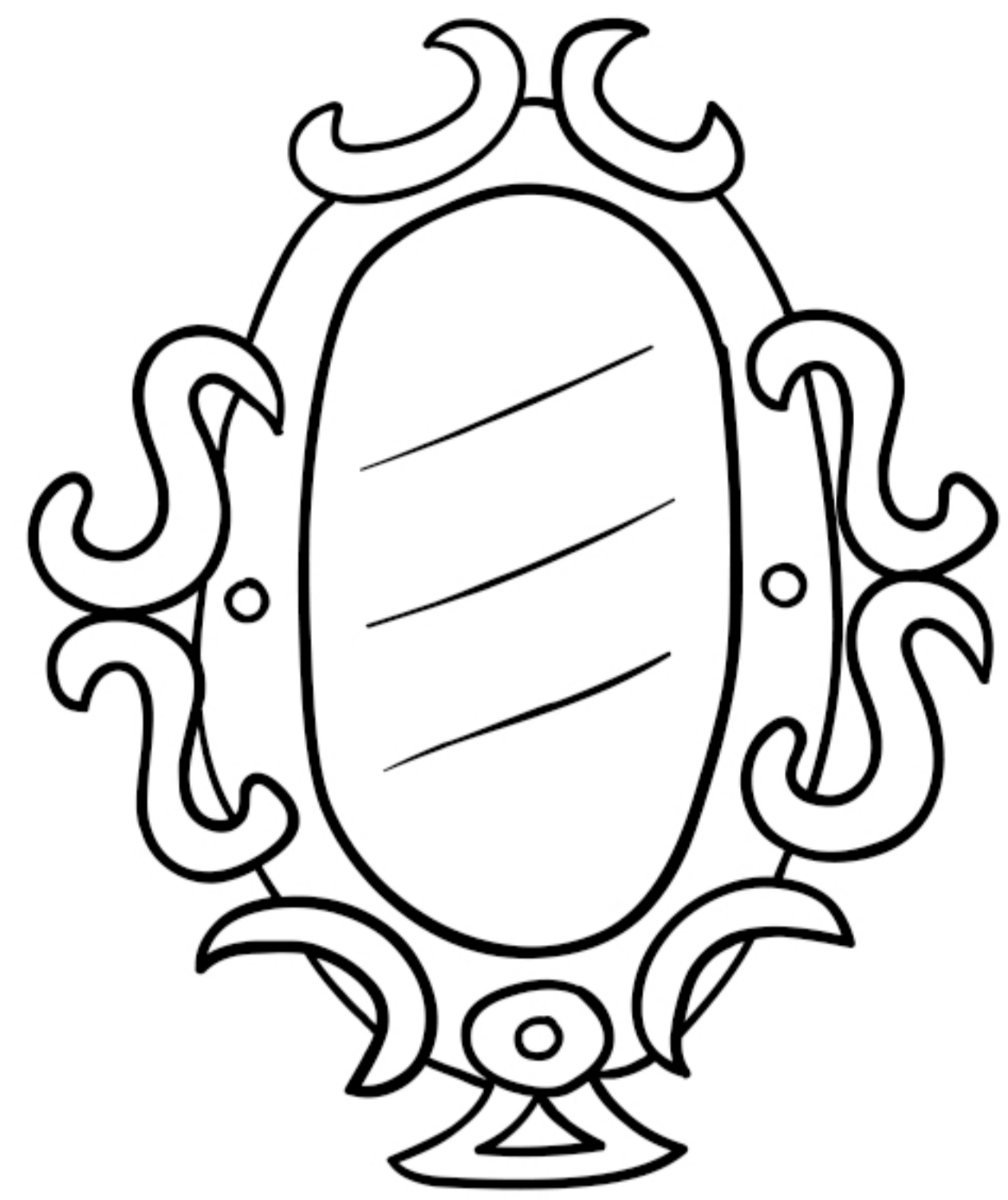

*en spegel*

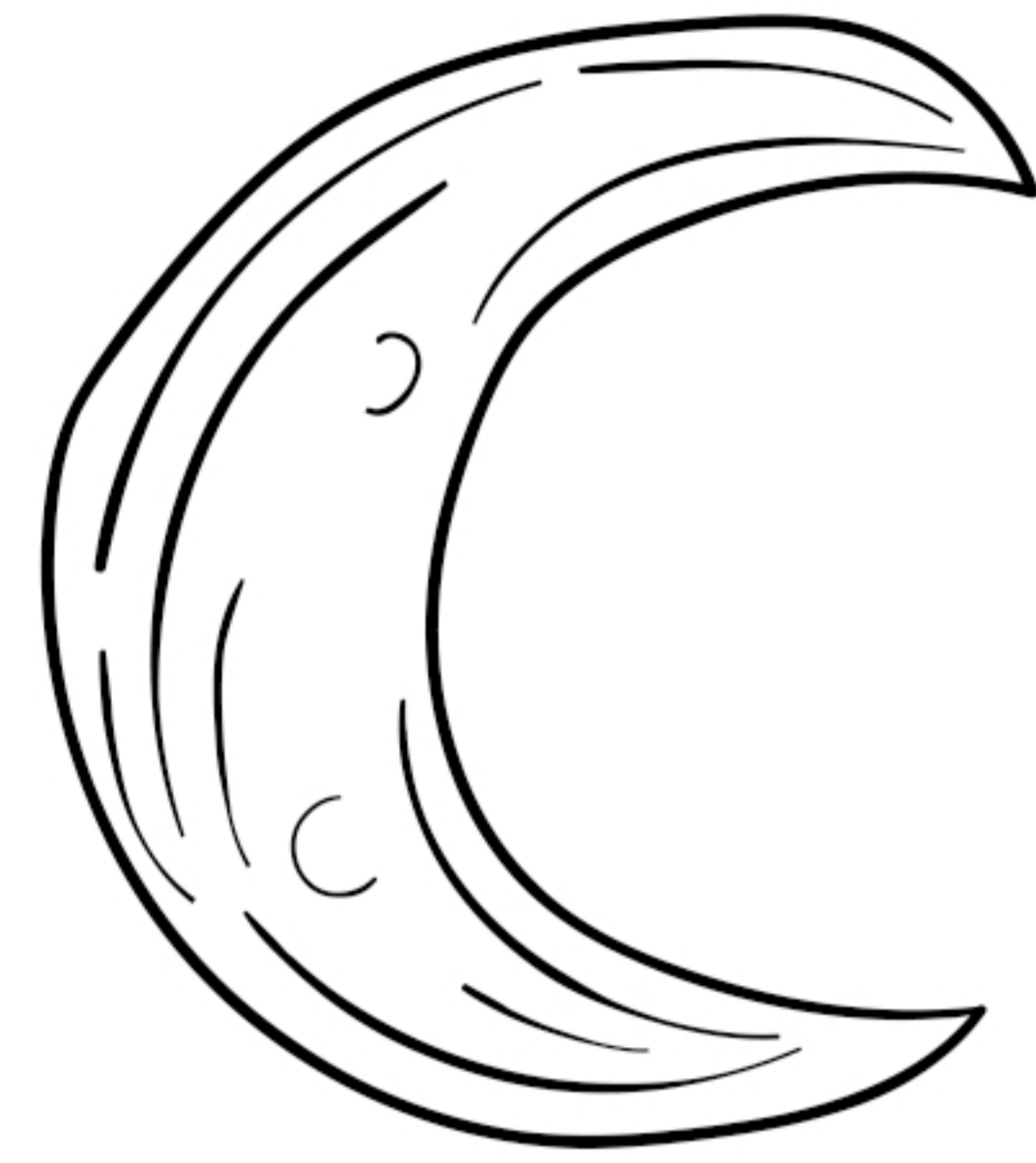

*en måne*

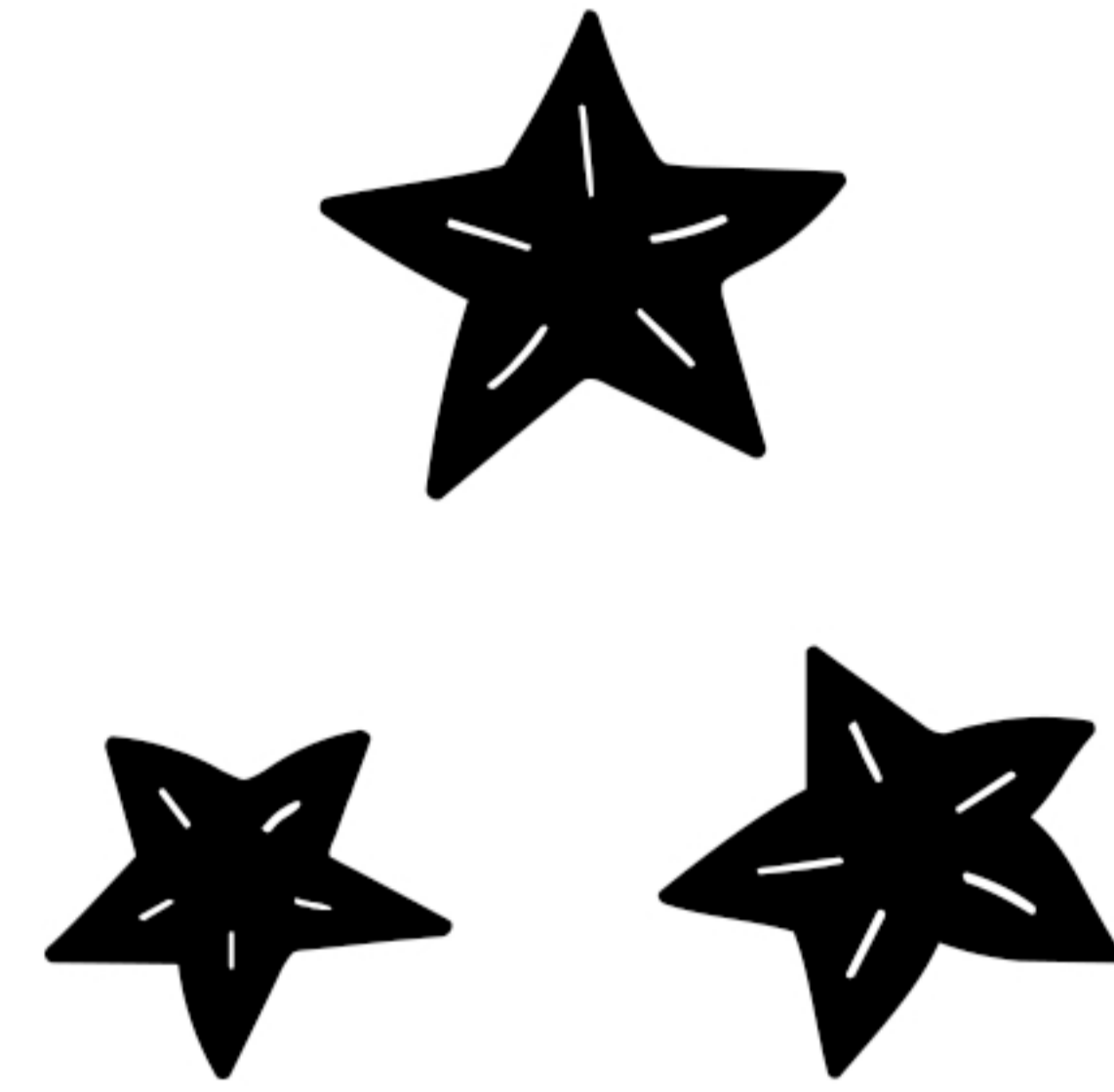

*några stjärnor*

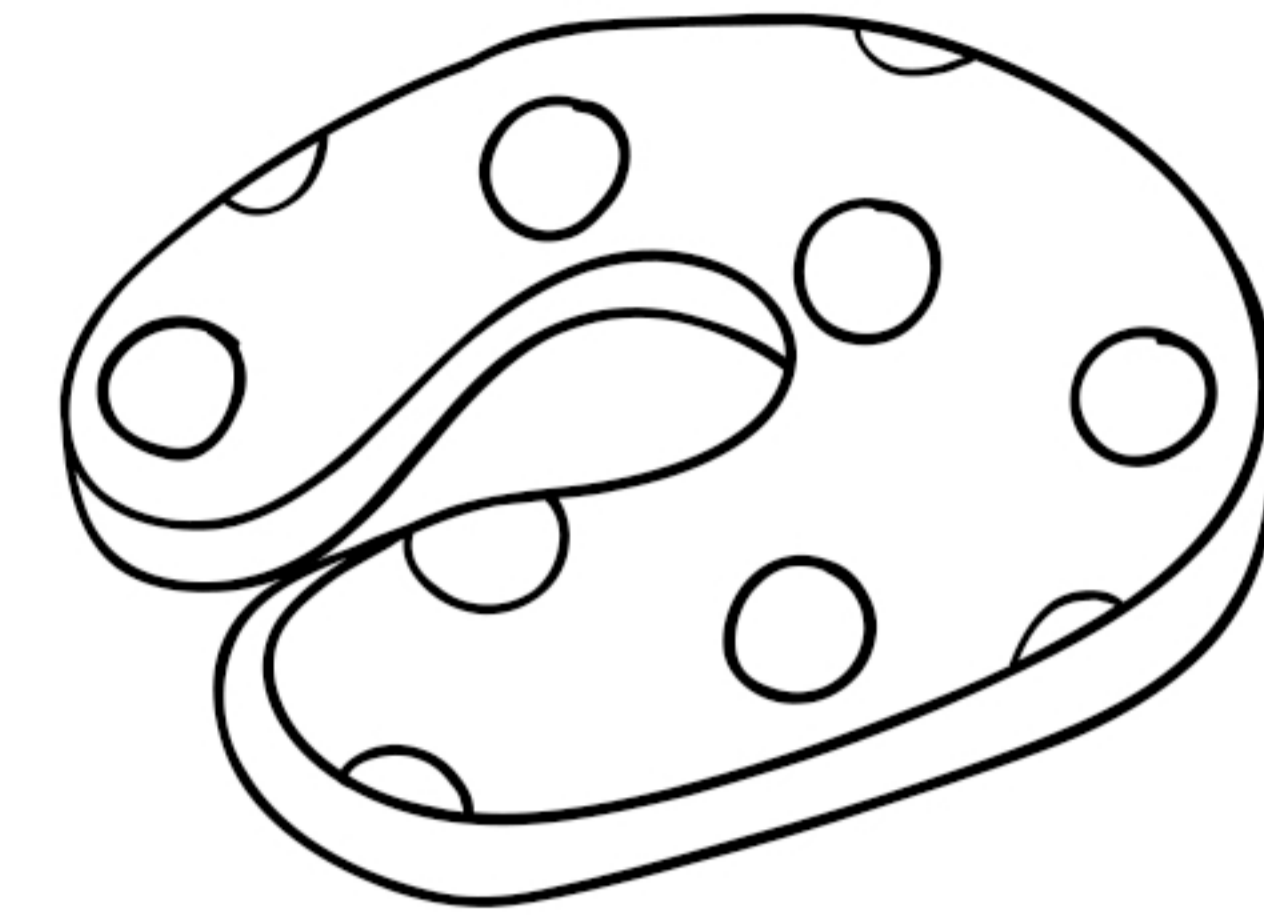

*en nackkudde*

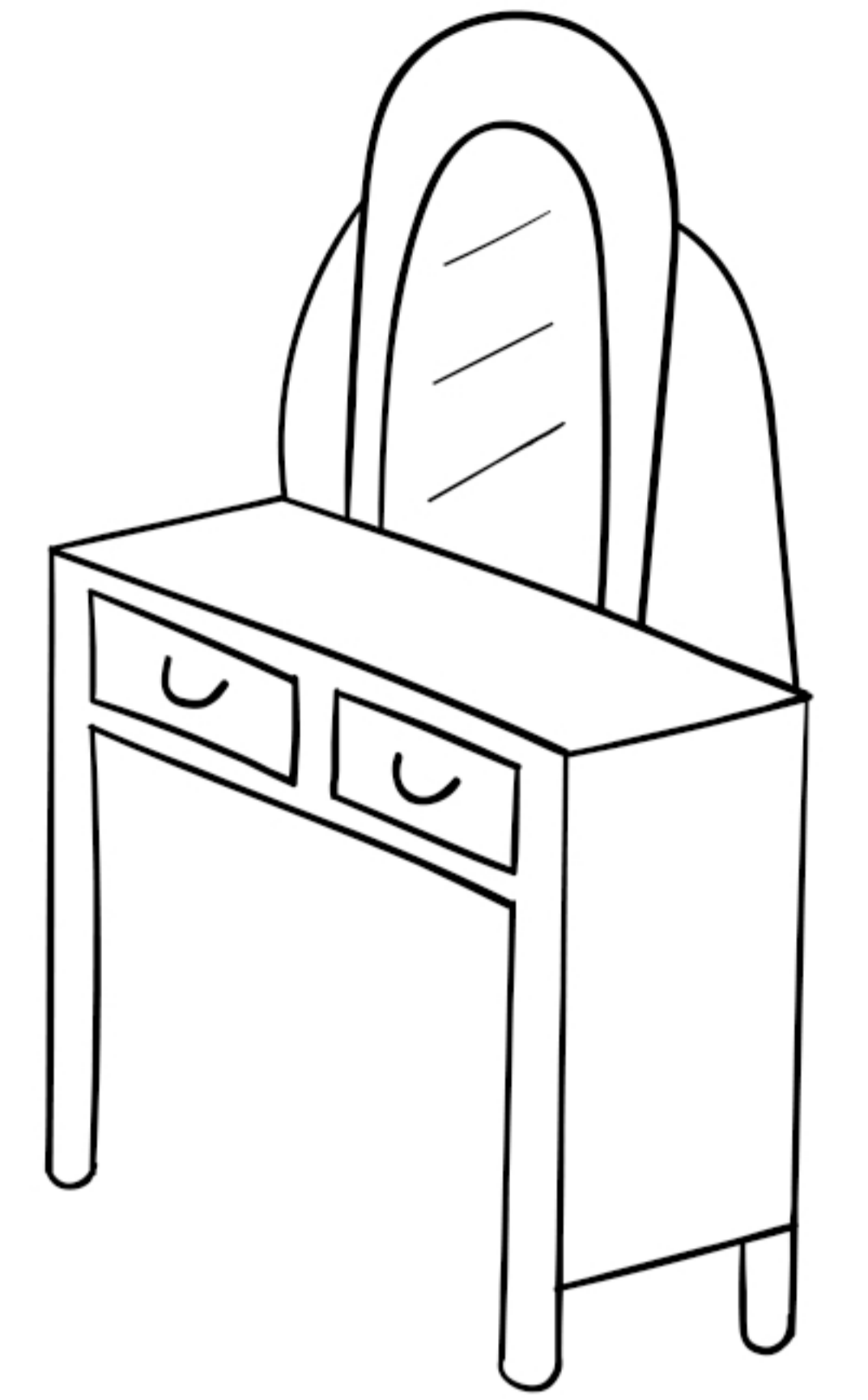

*ett sminkbord*

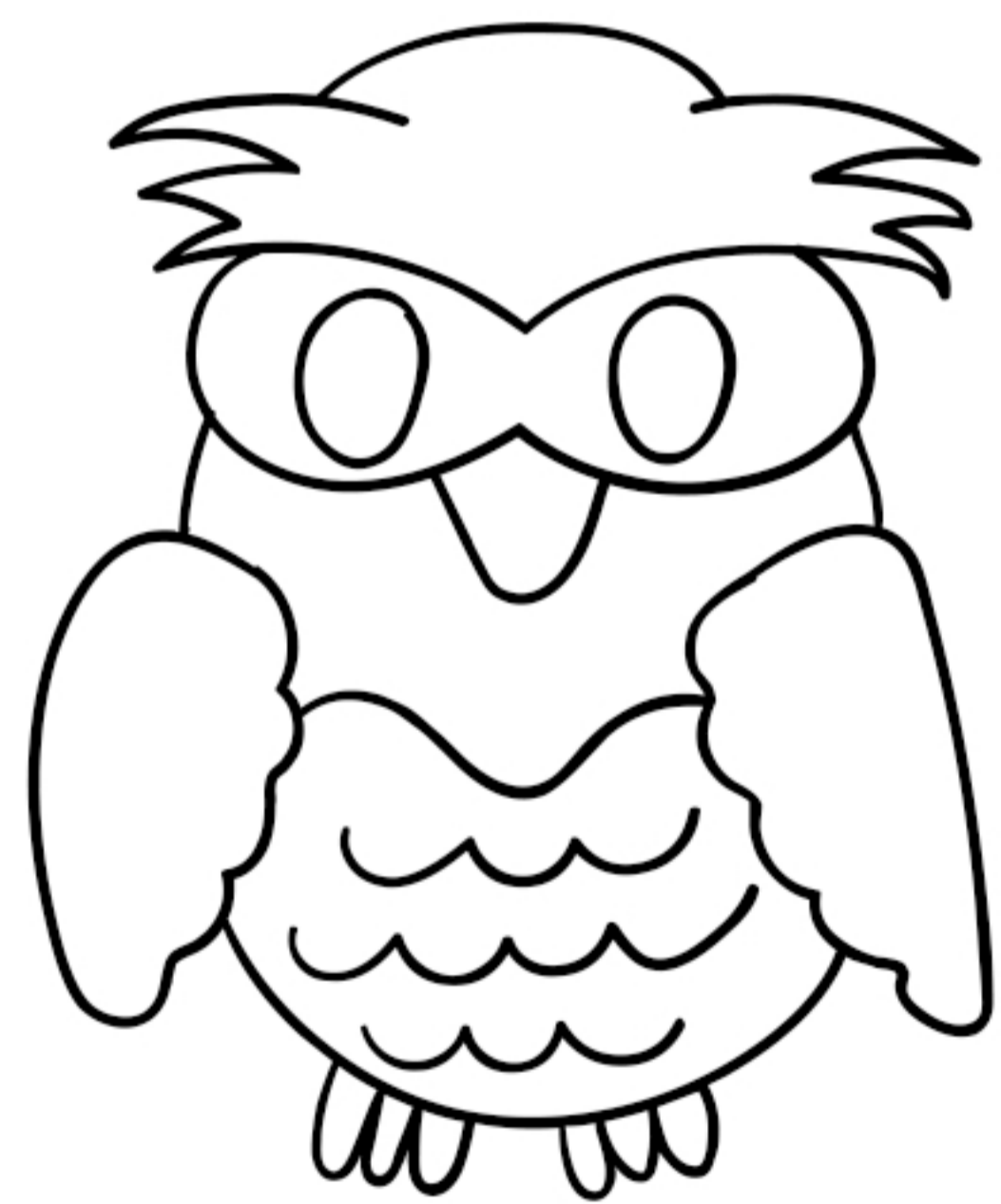

*en uggla*

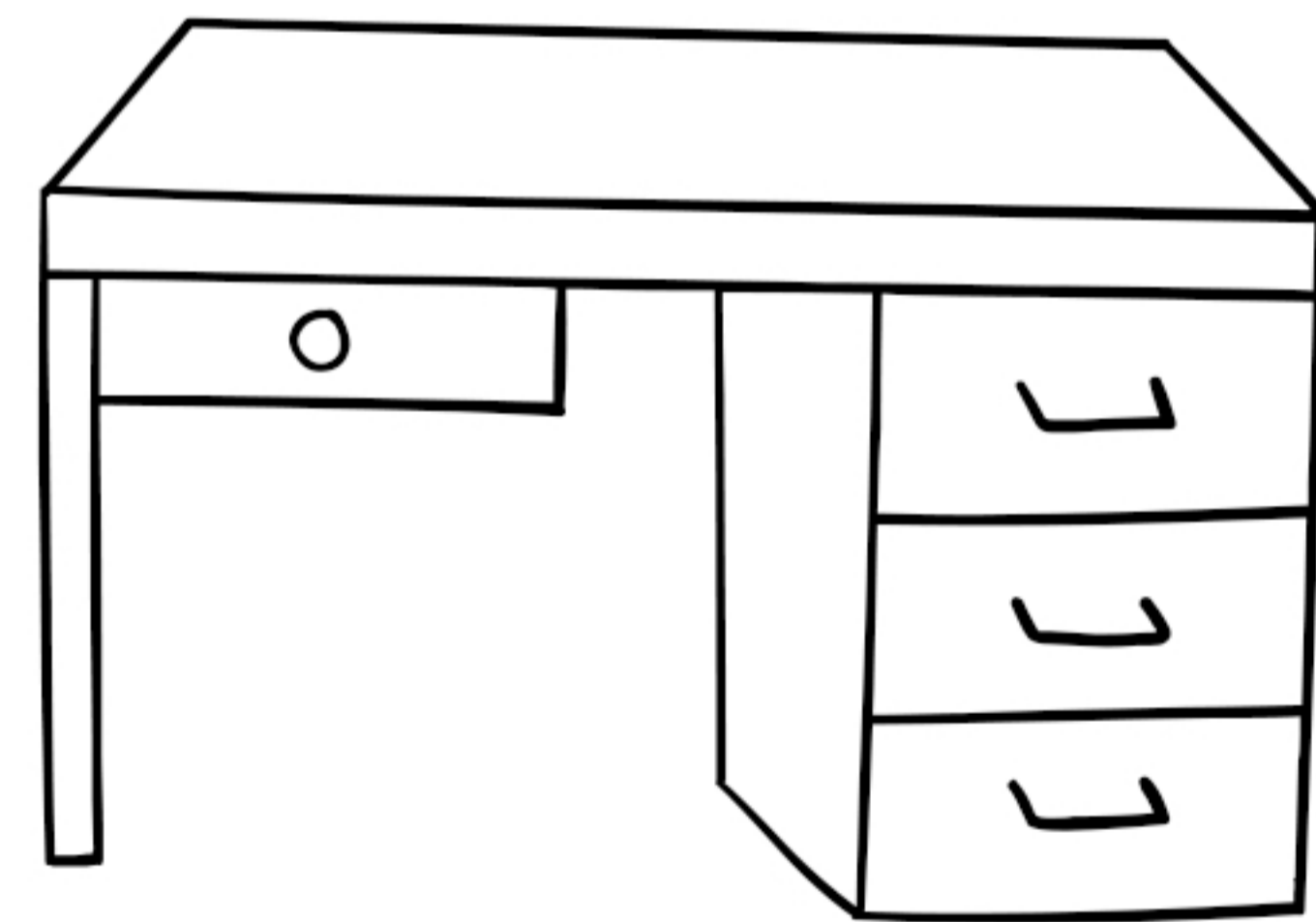

*ett skrivbord*

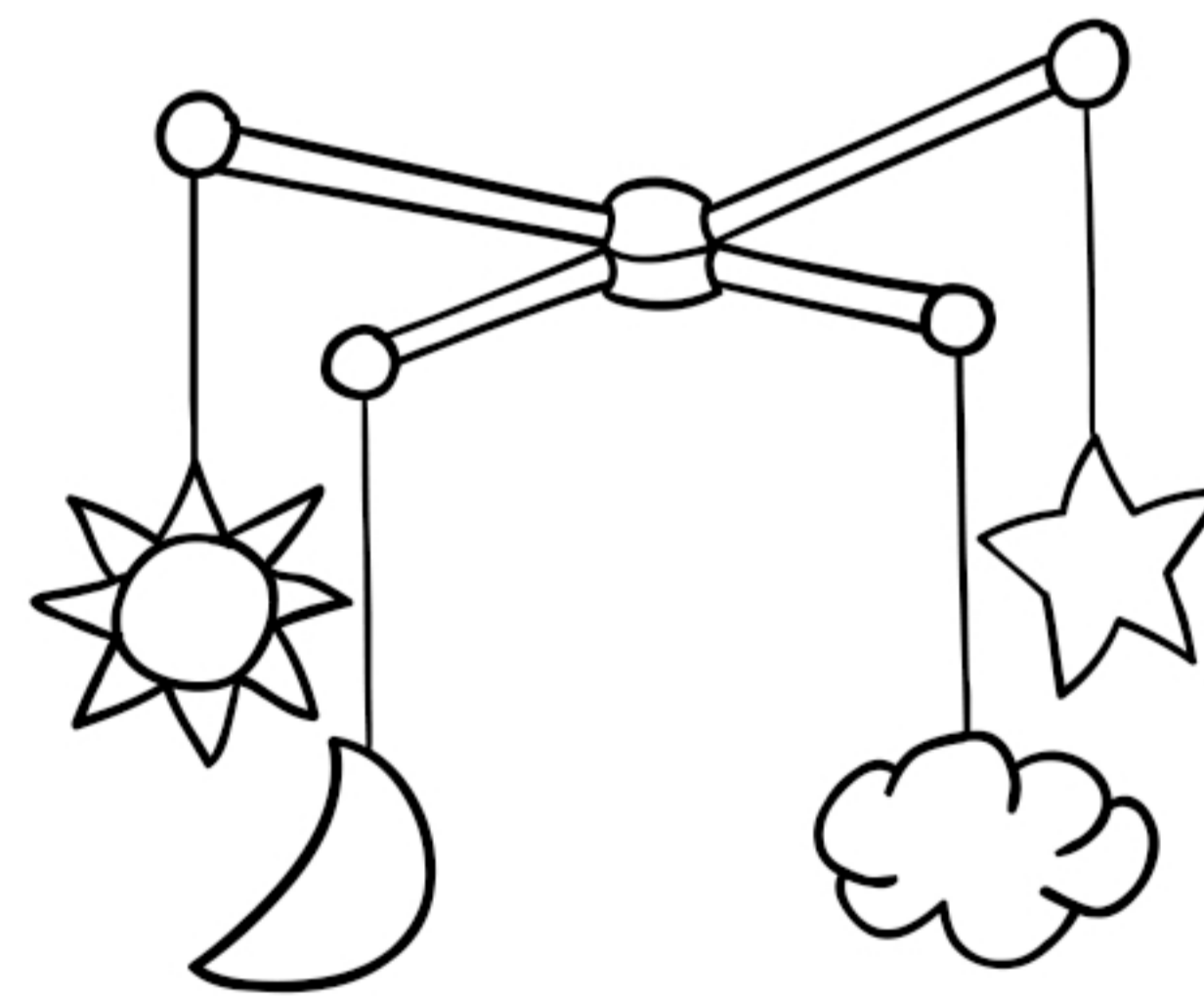

*en mobil*



*en nalle*



*en dubbelsäng*

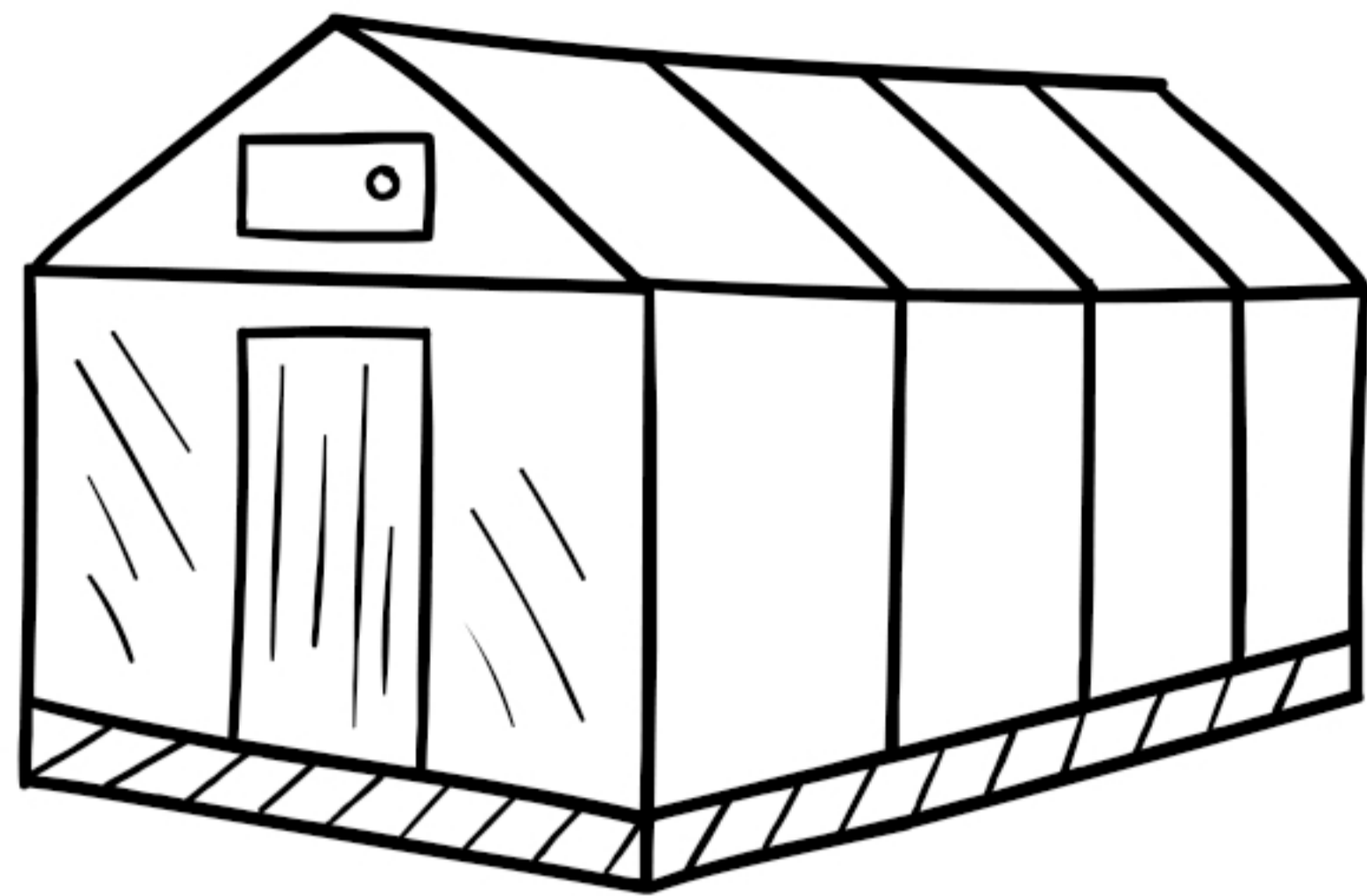

*ett växthus*



*en skottkärra*

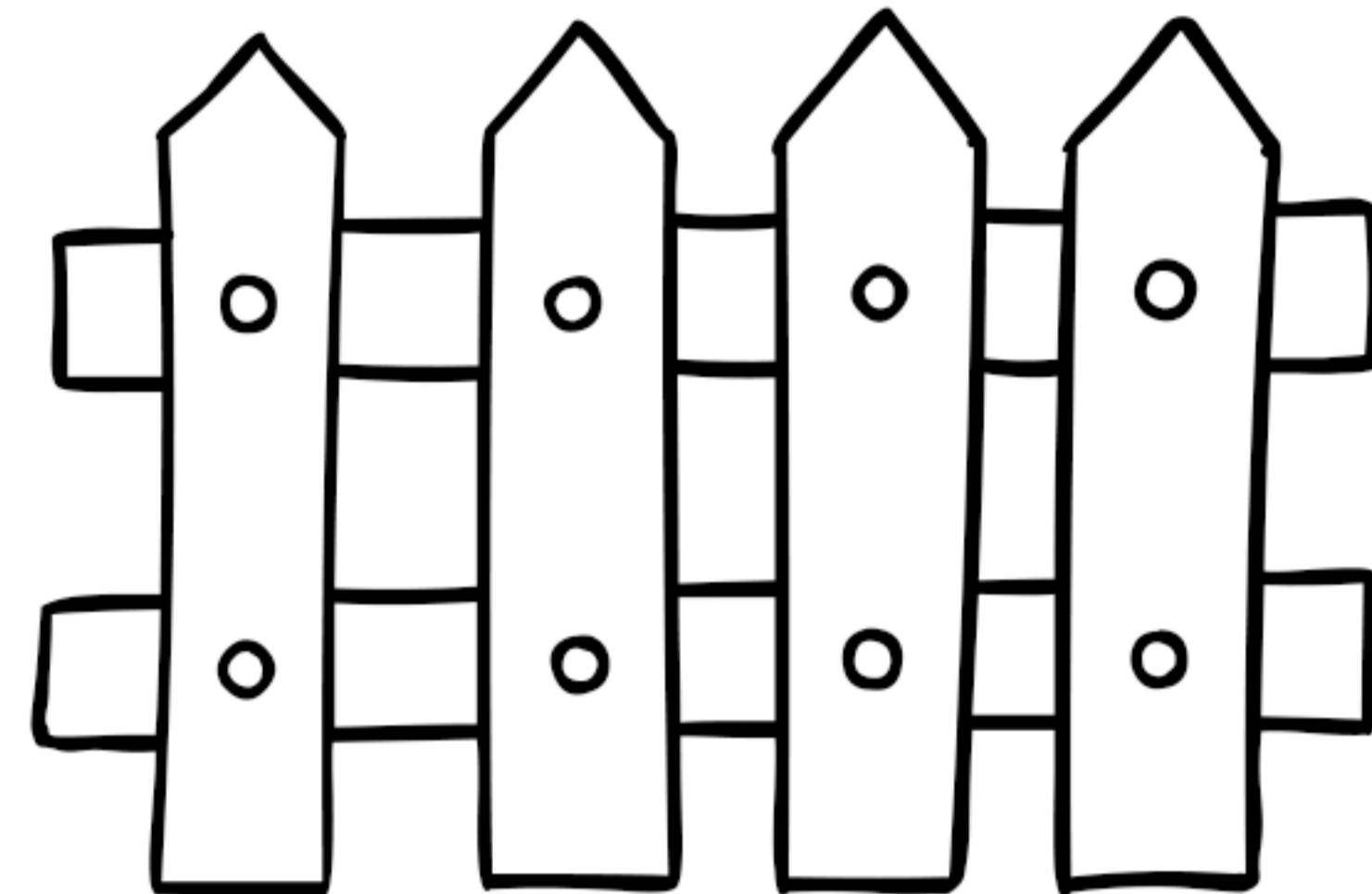

*ett staket*

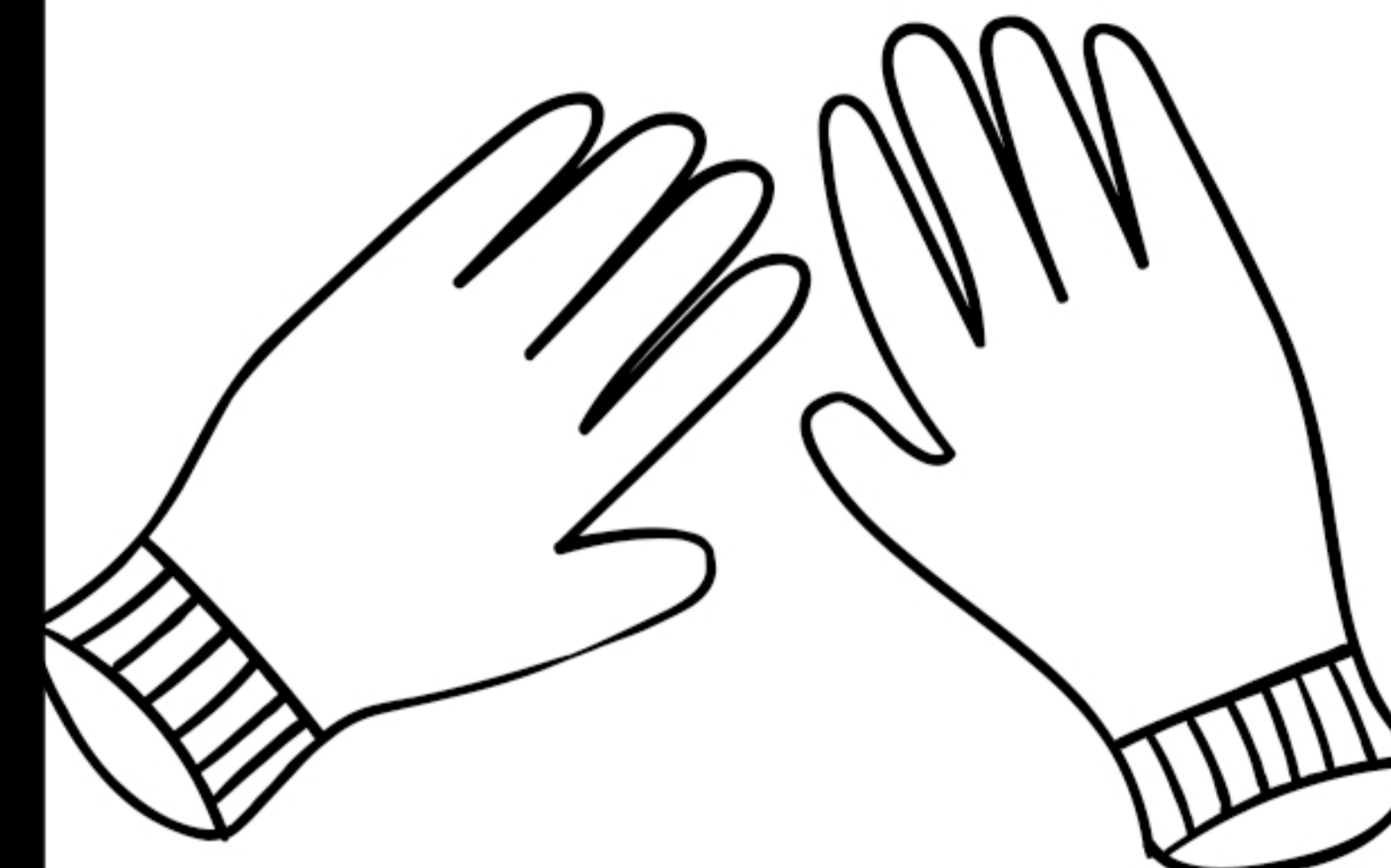

*ett par handskar*

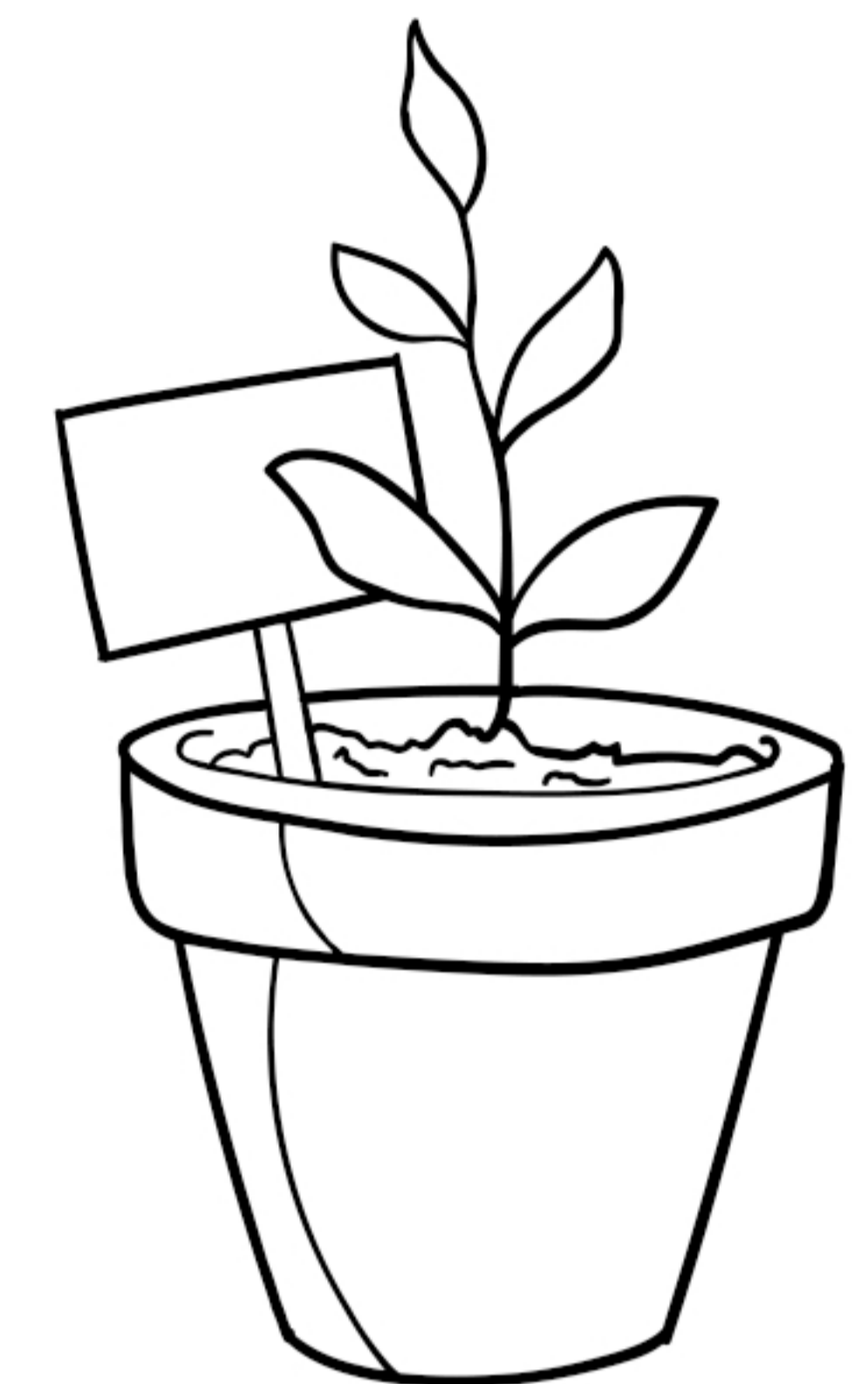

*en stickling*

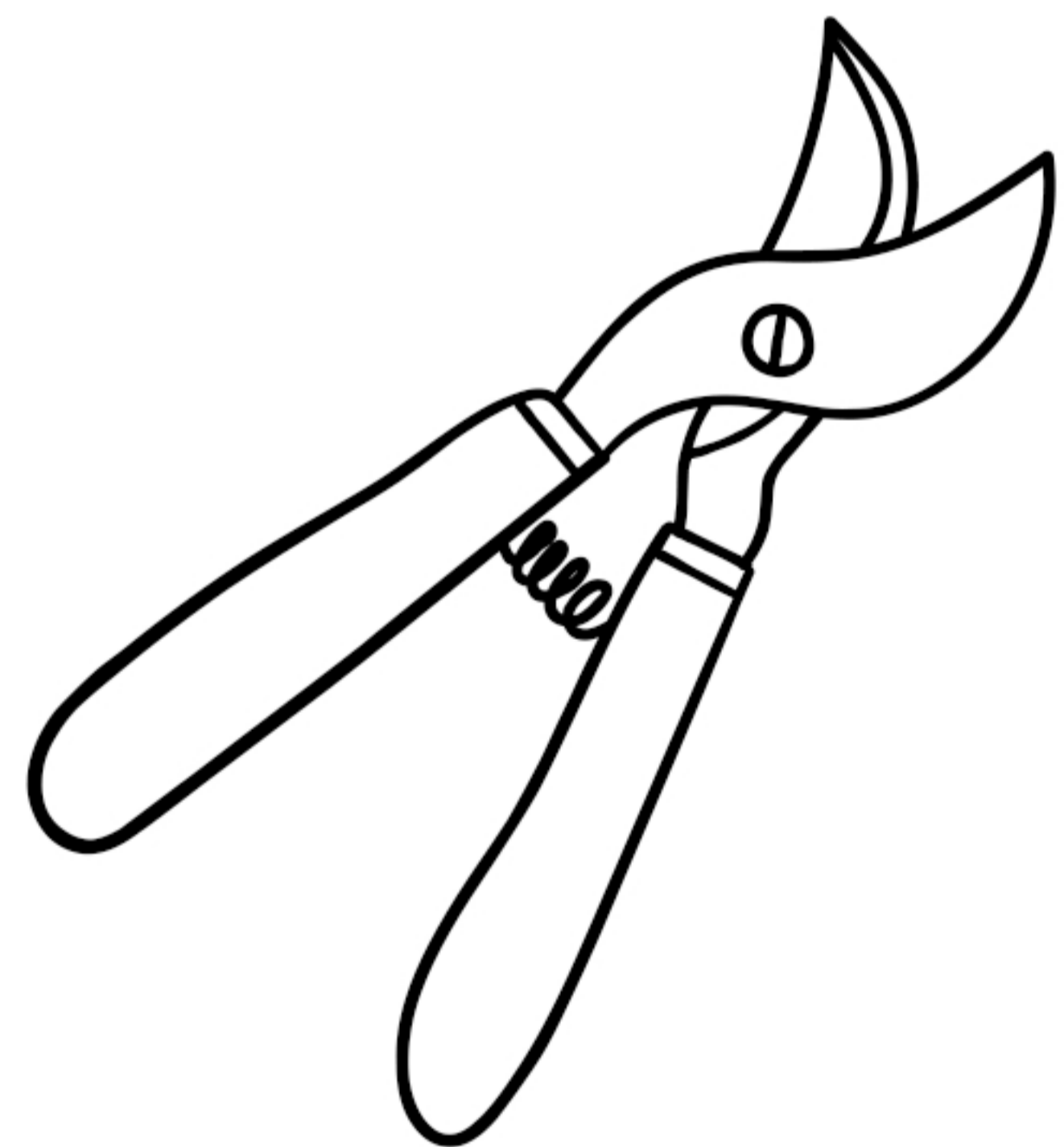

*en sekator*

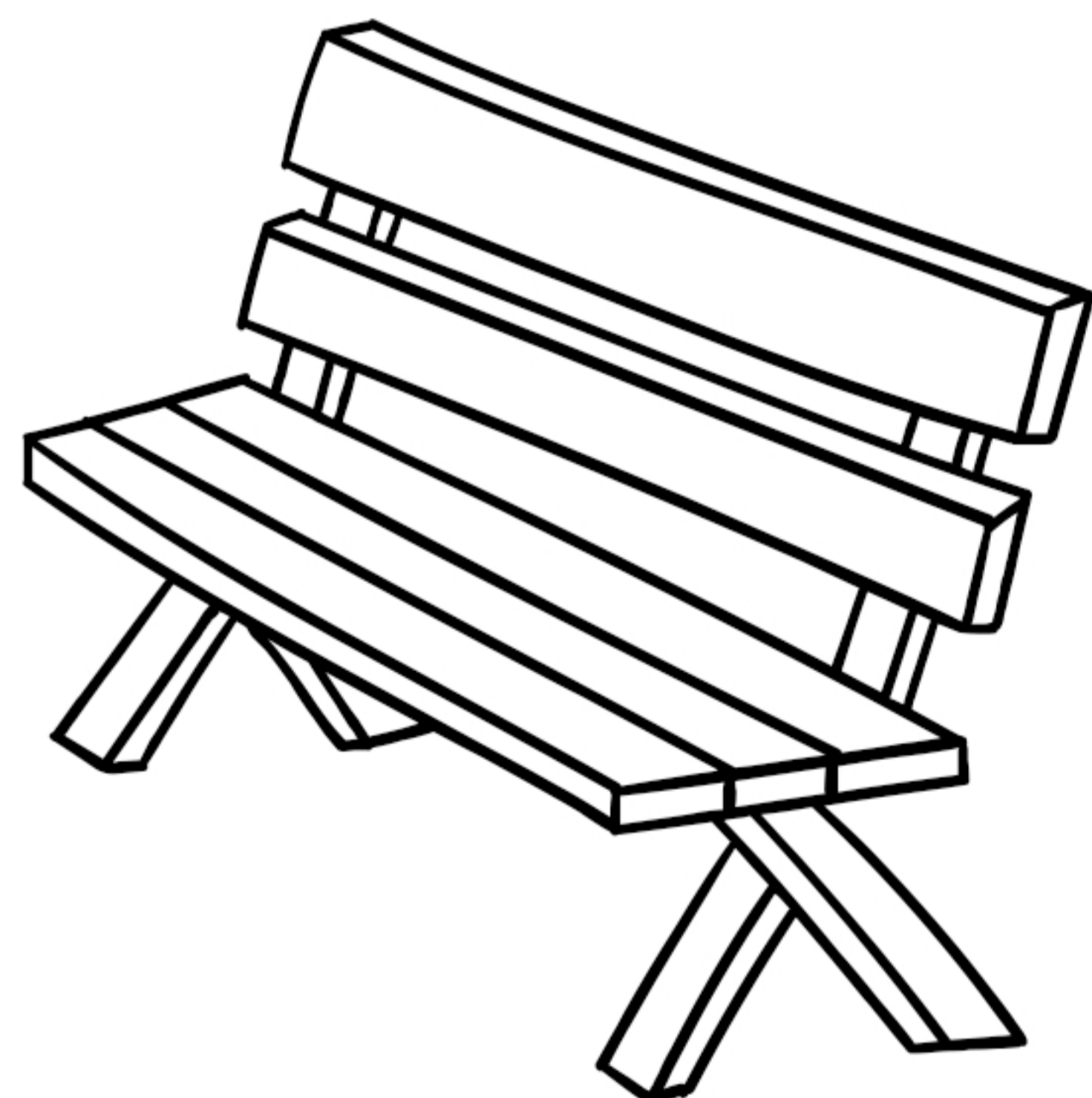

*en trädgårdssoffa*

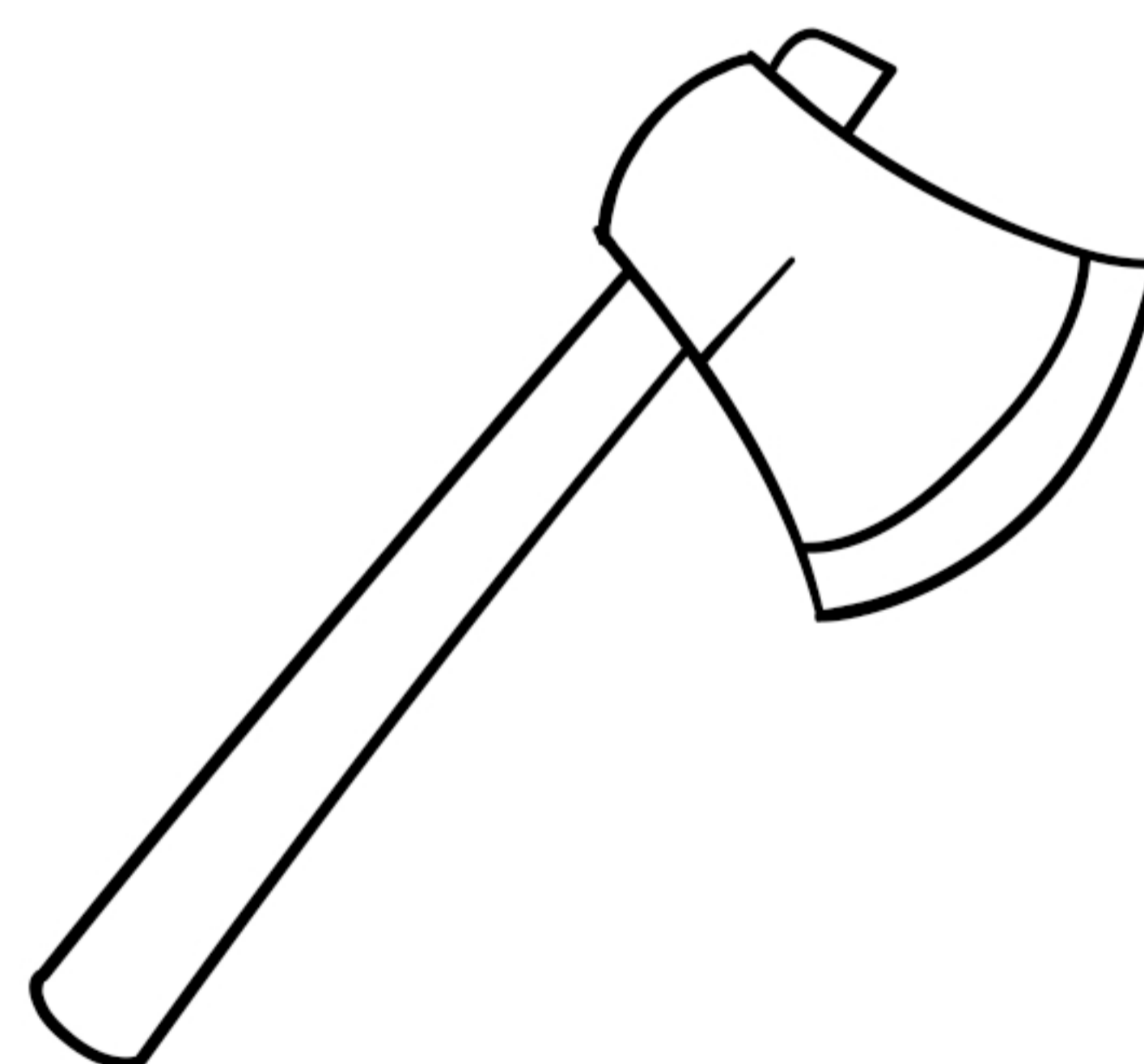

*en yxa*

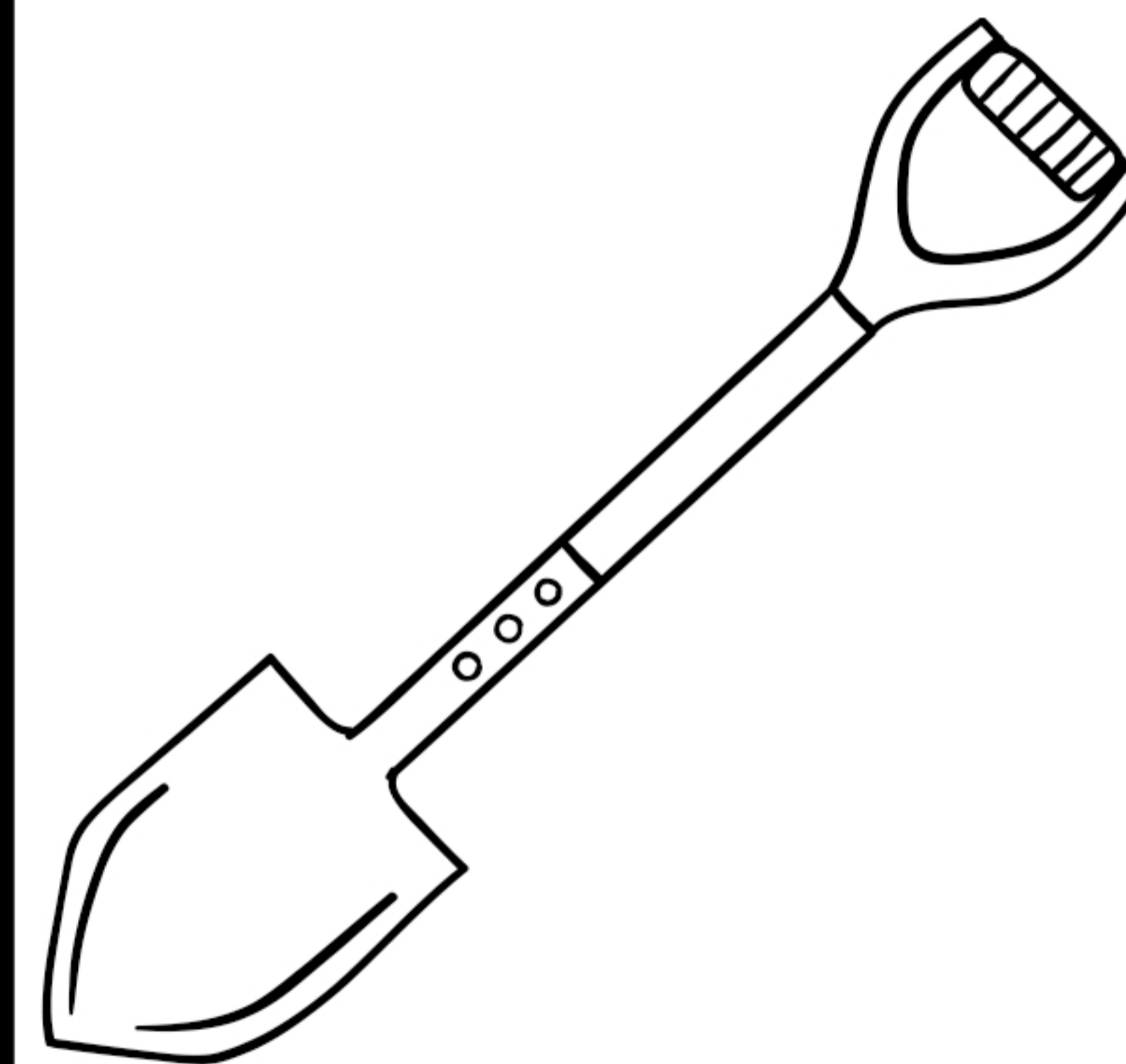

*en spade*

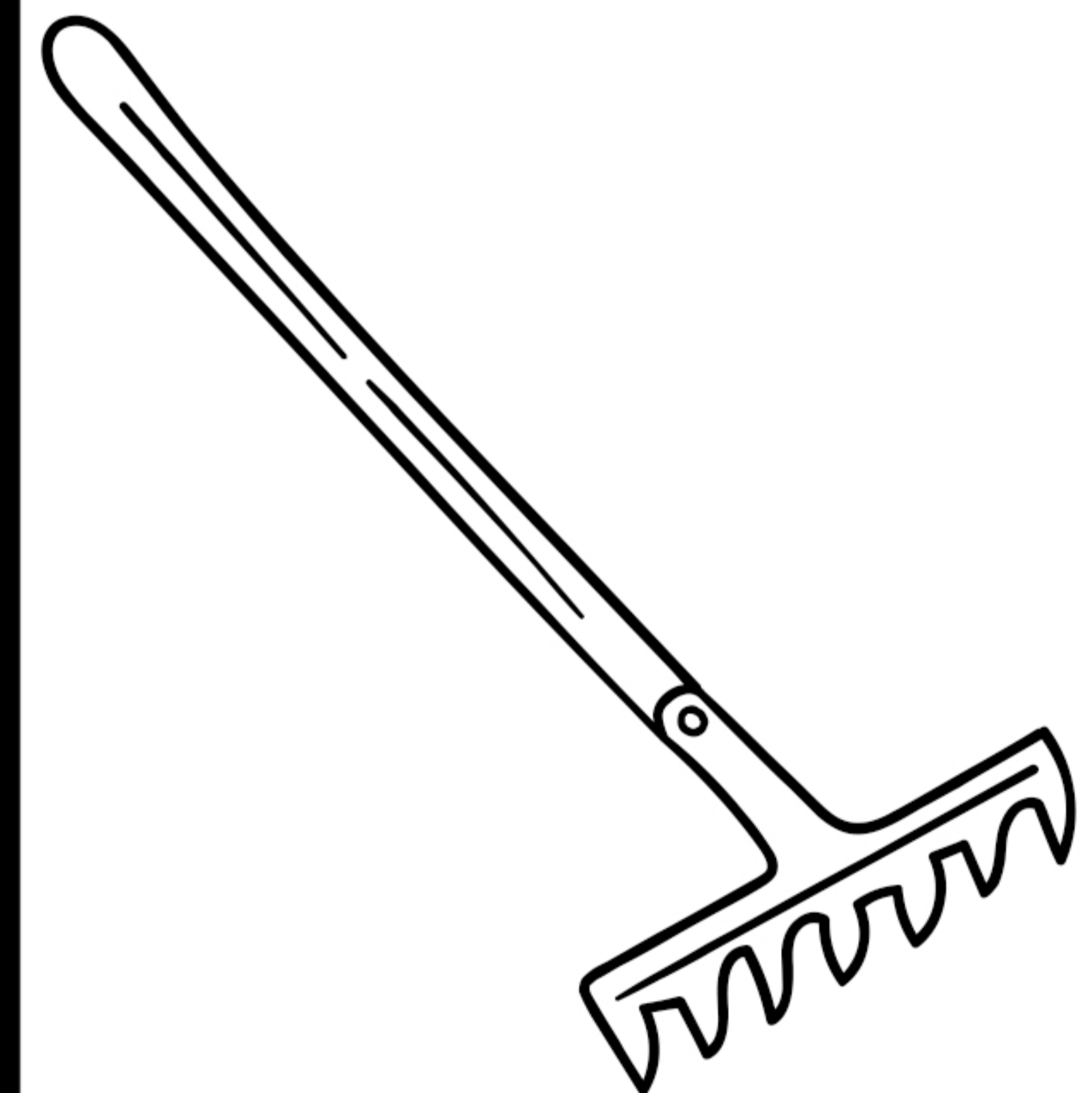

*en kratta*

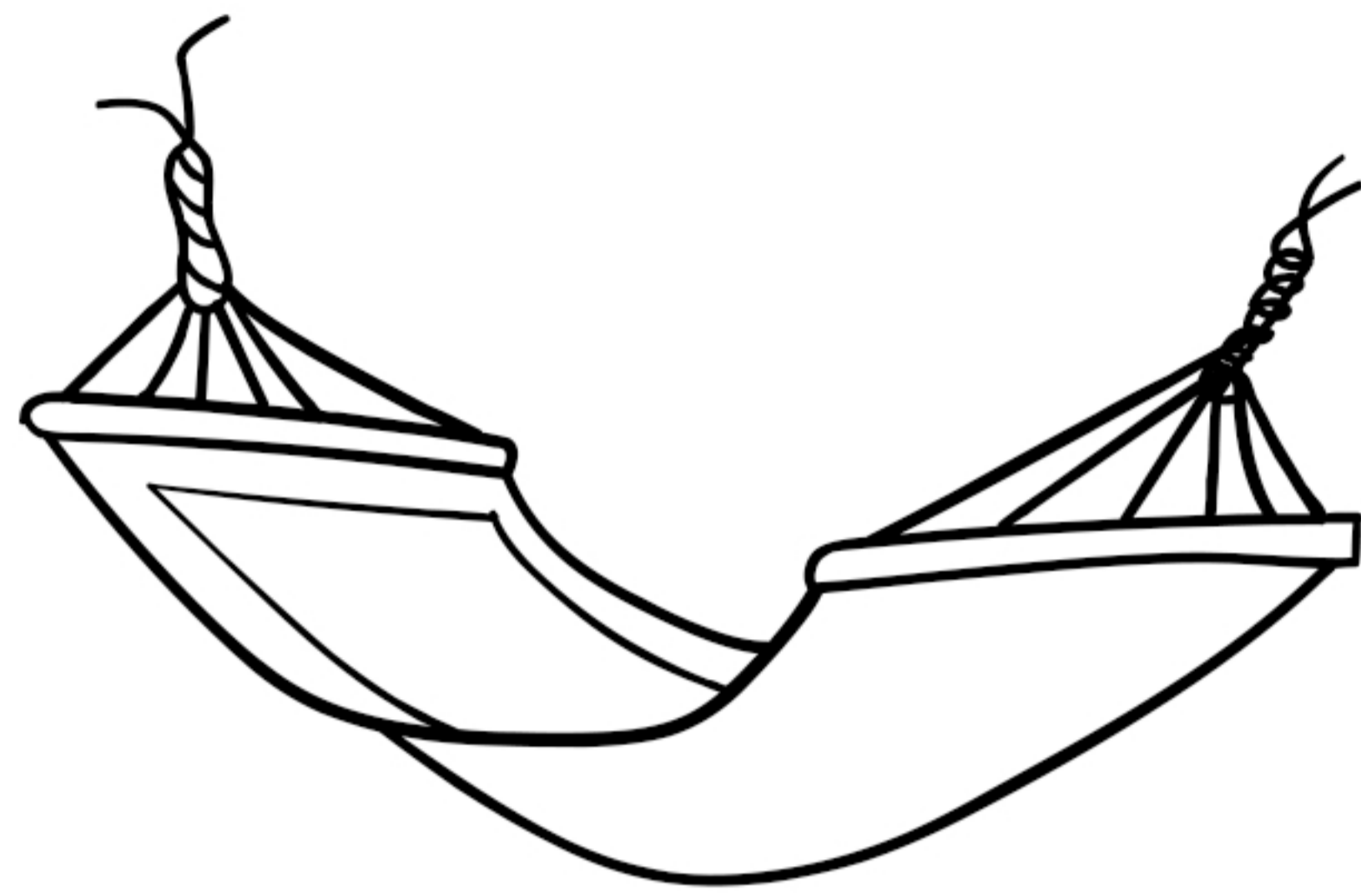

*en hängmatta*

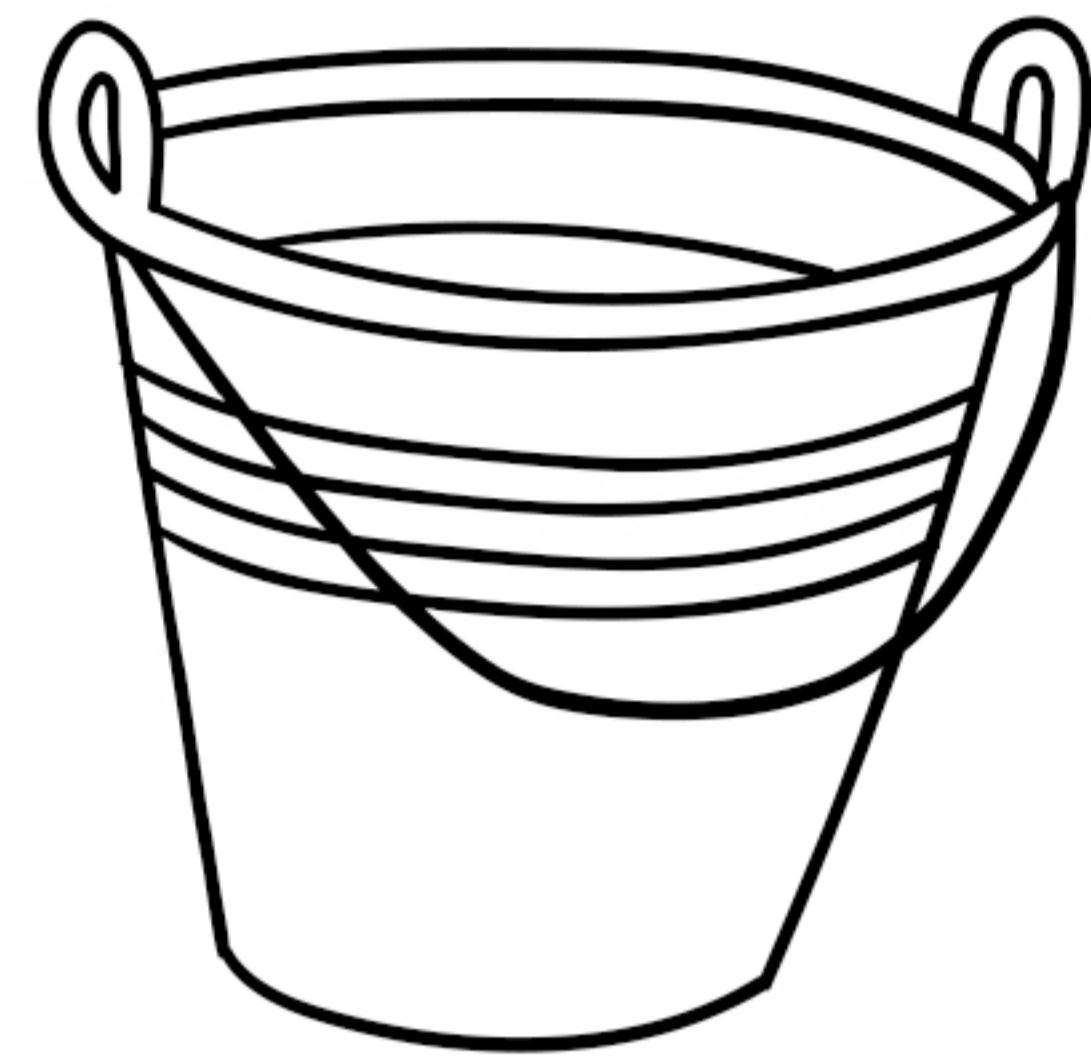

*en hink*

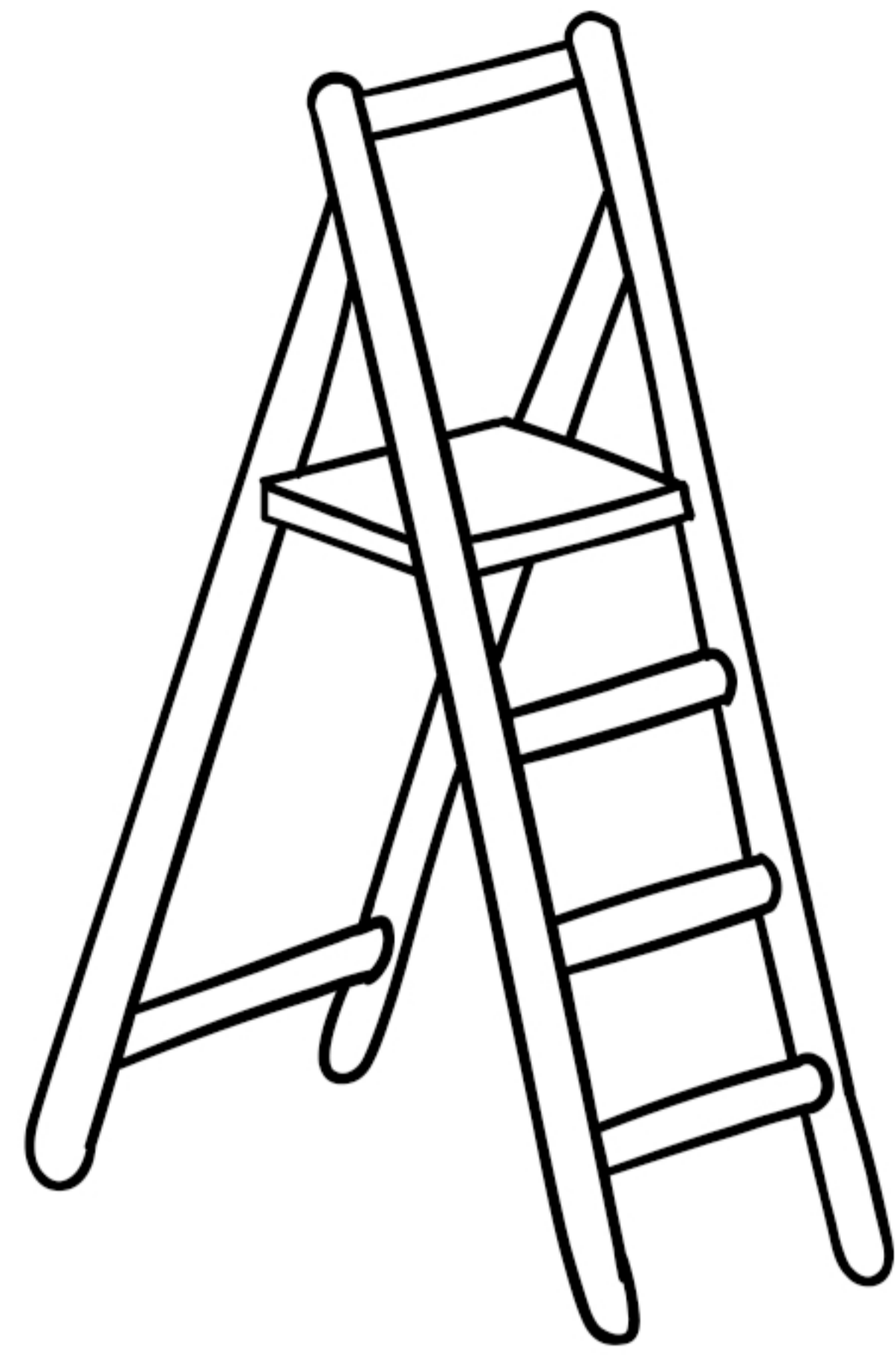

*en stege*

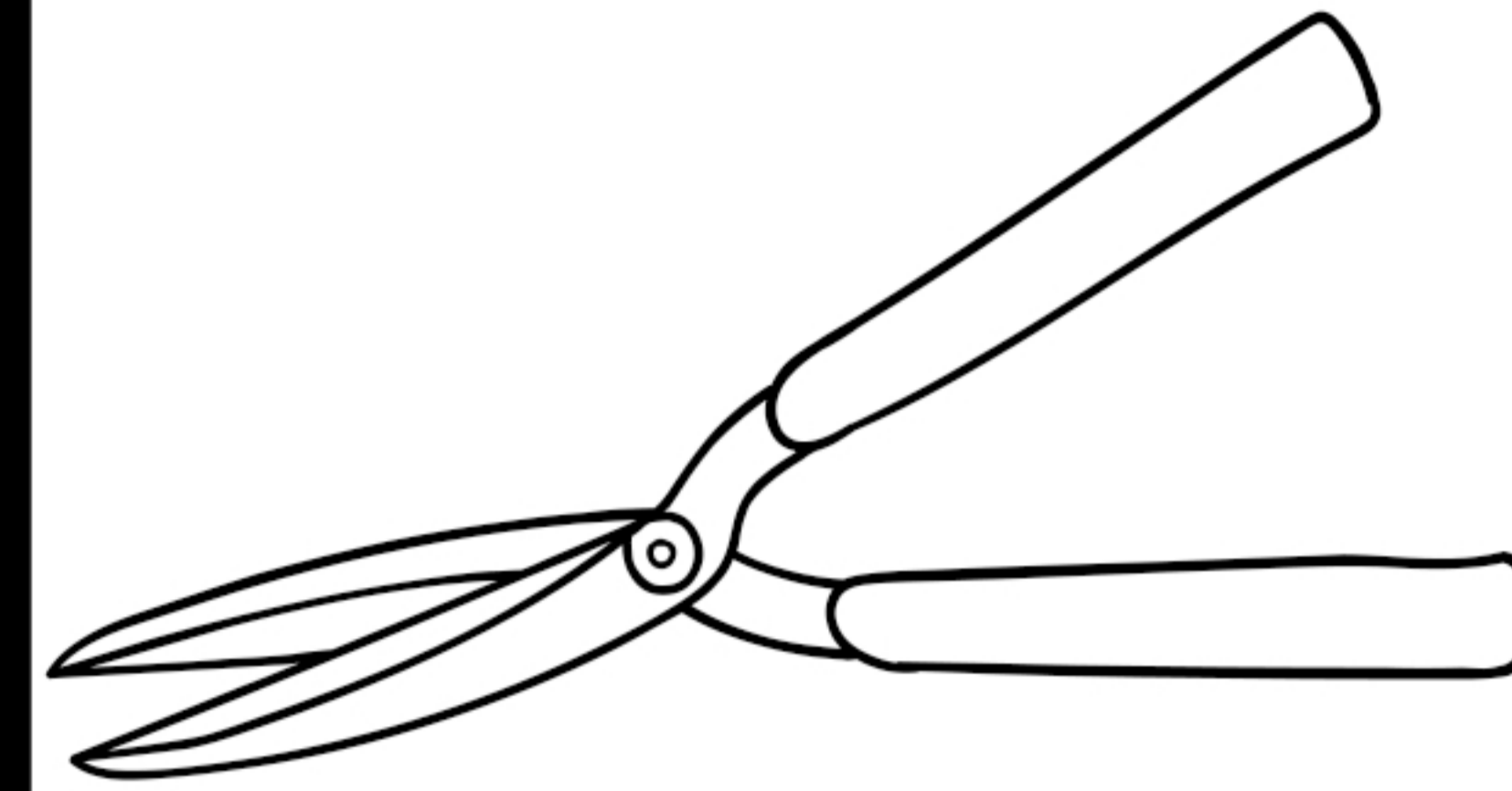

*en häcksax*



*en fågelholk*

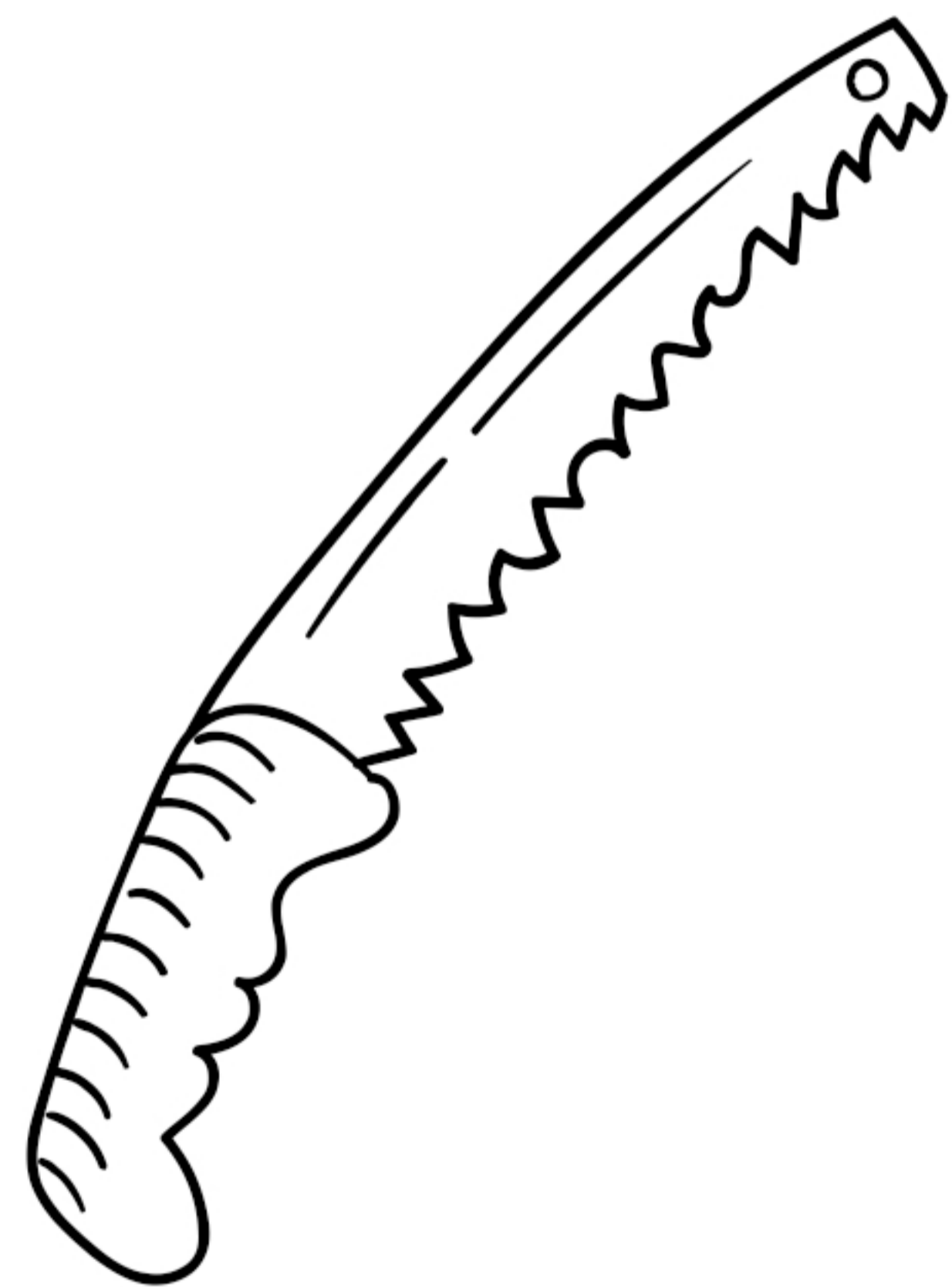

*en grensåg*

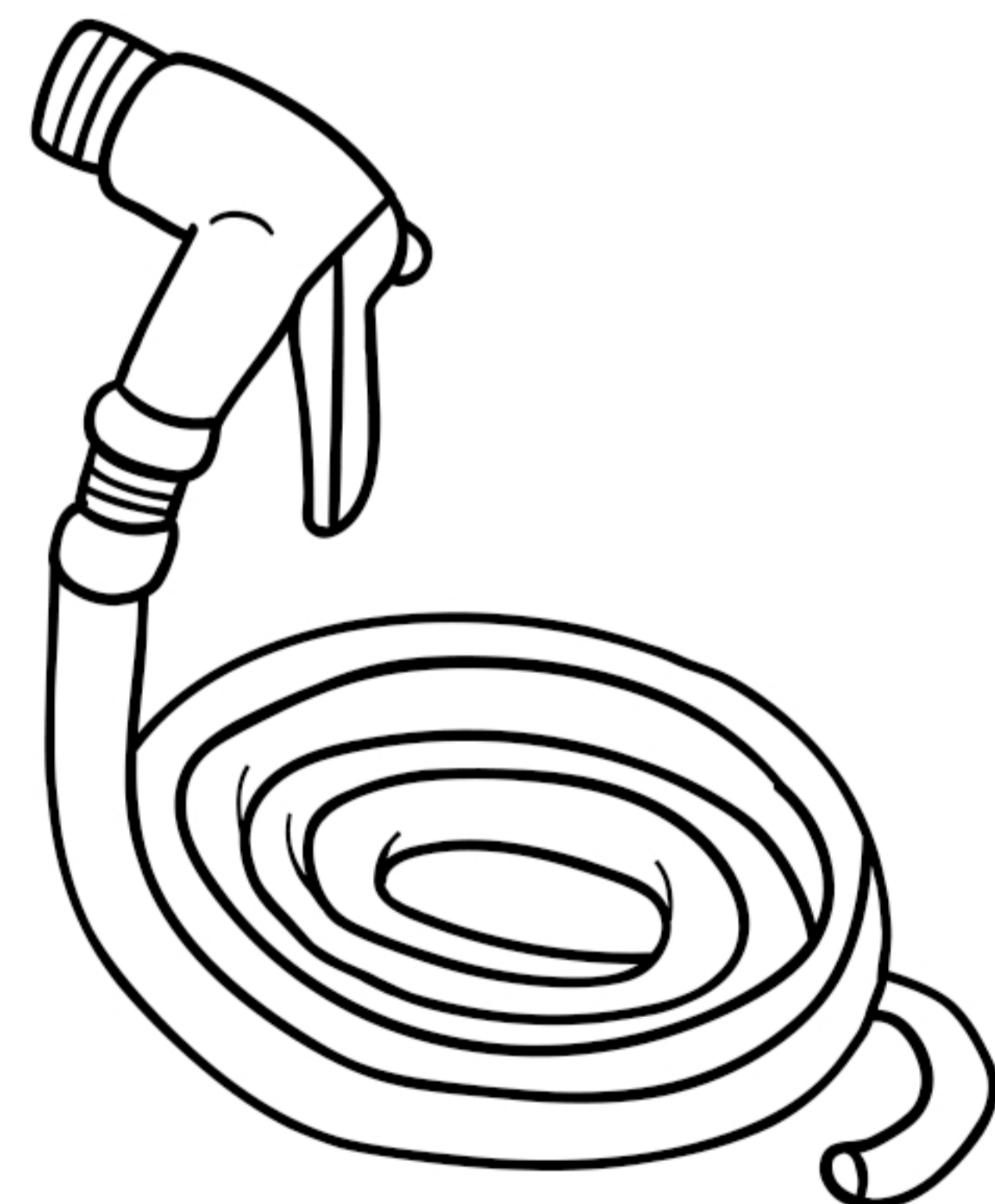

*en vattenslang*

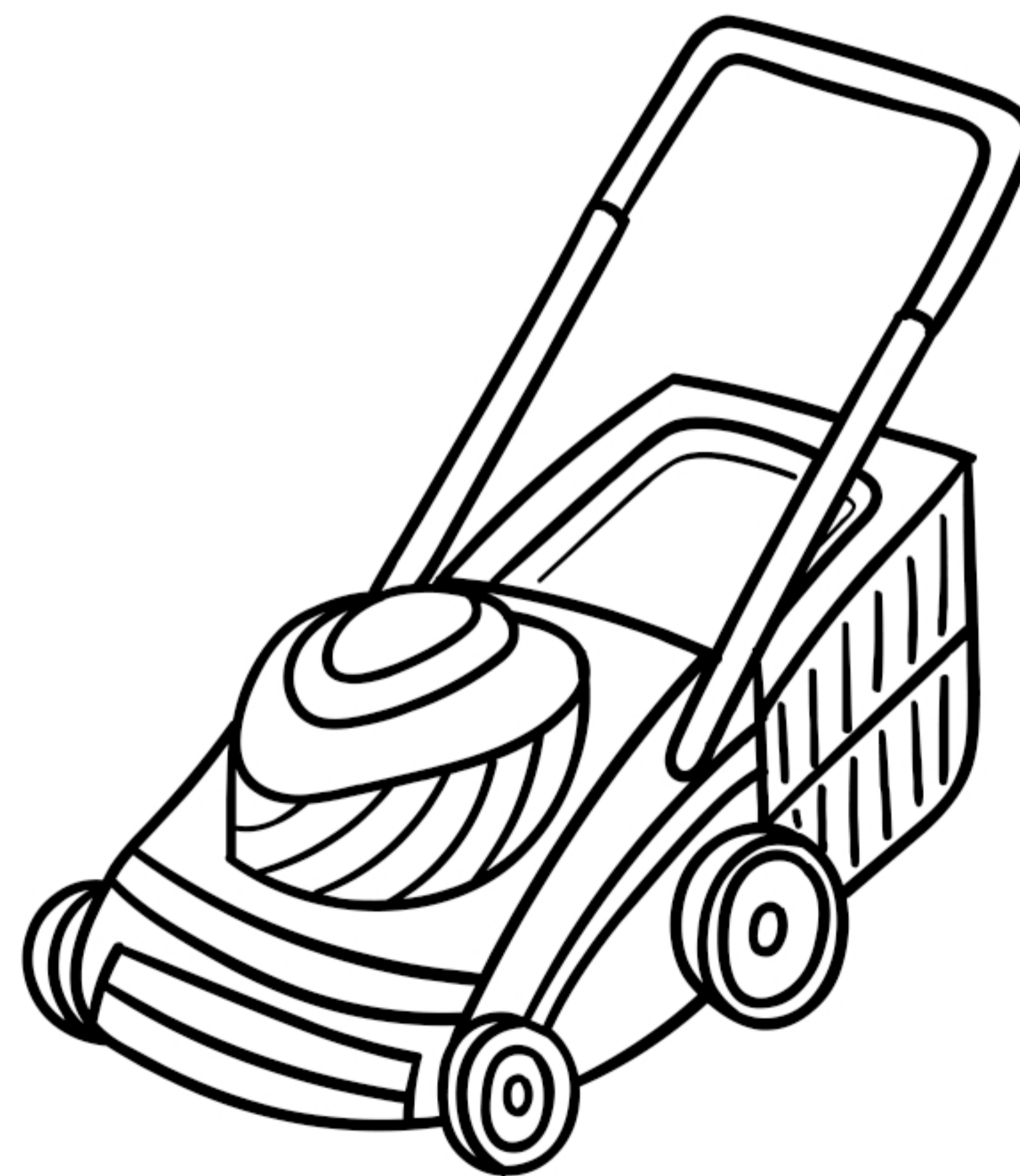

*en gräsklippare*

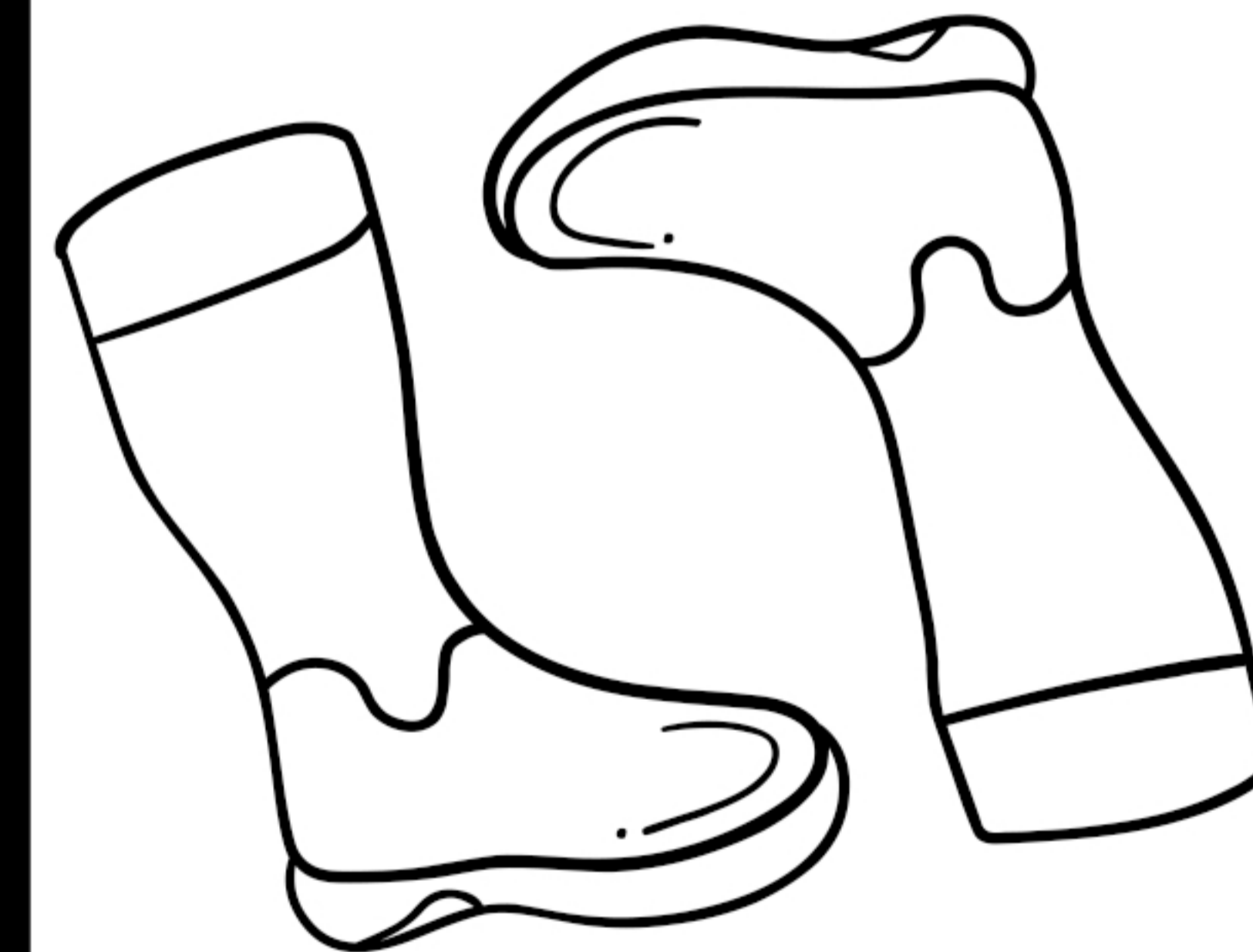

*ett par stövlar*

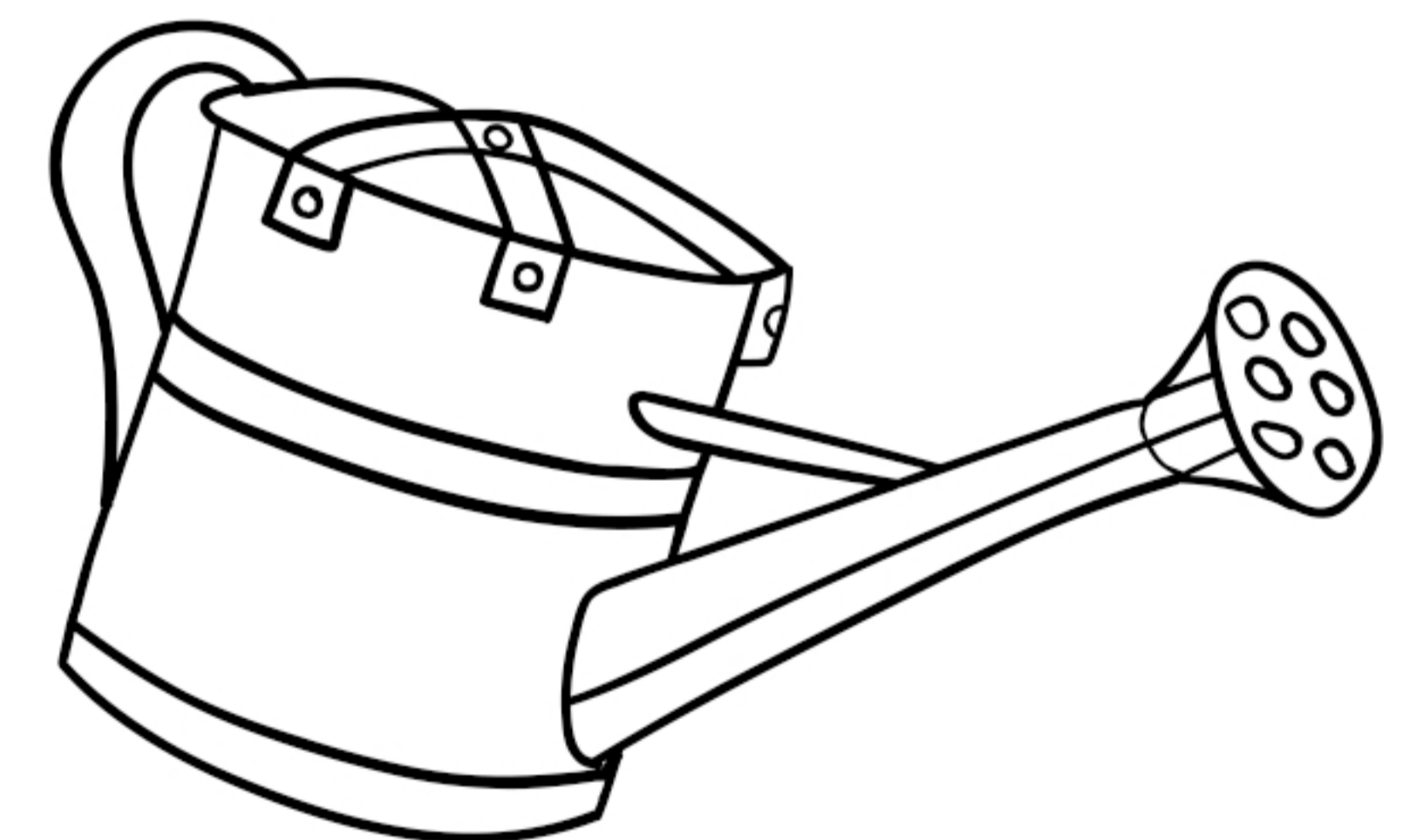

*en vattenkanna*

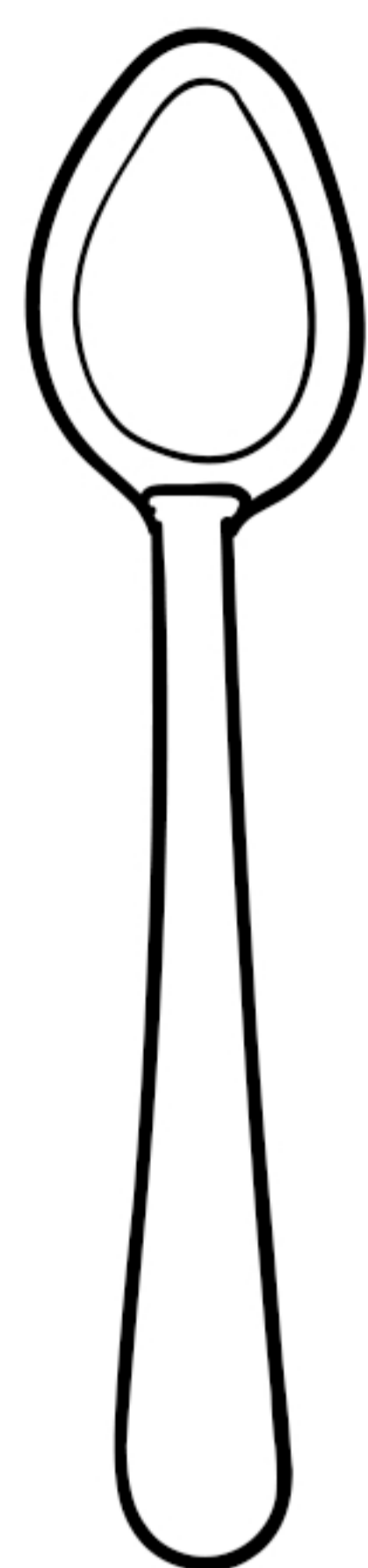

*en träsked*



*ett litermått*

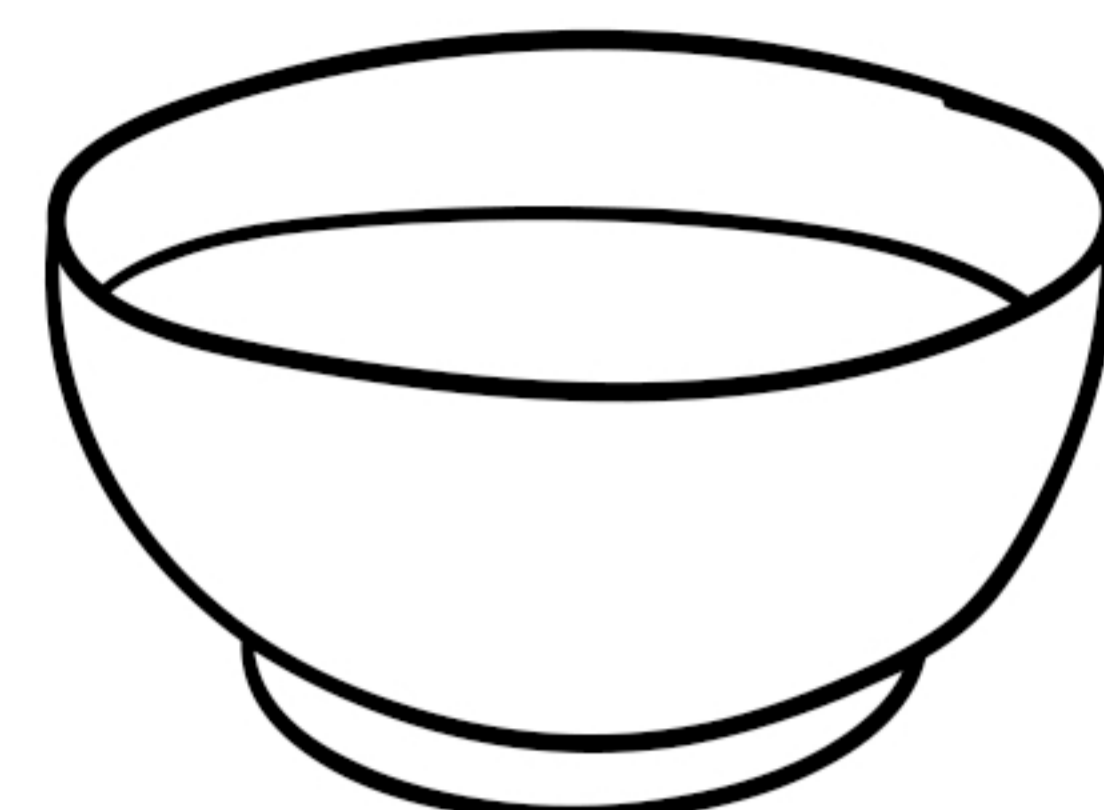

*en bunke*

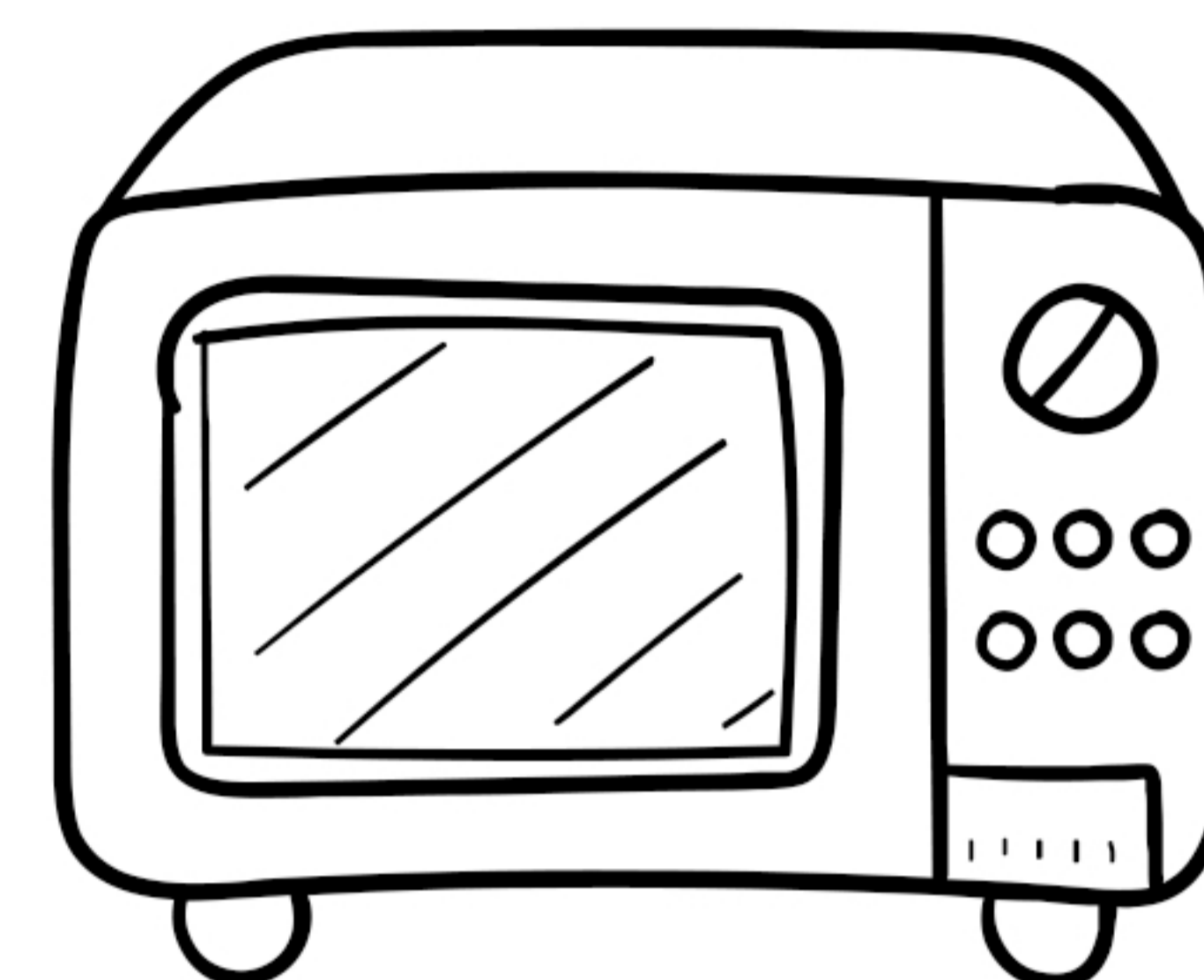

*en mikro*

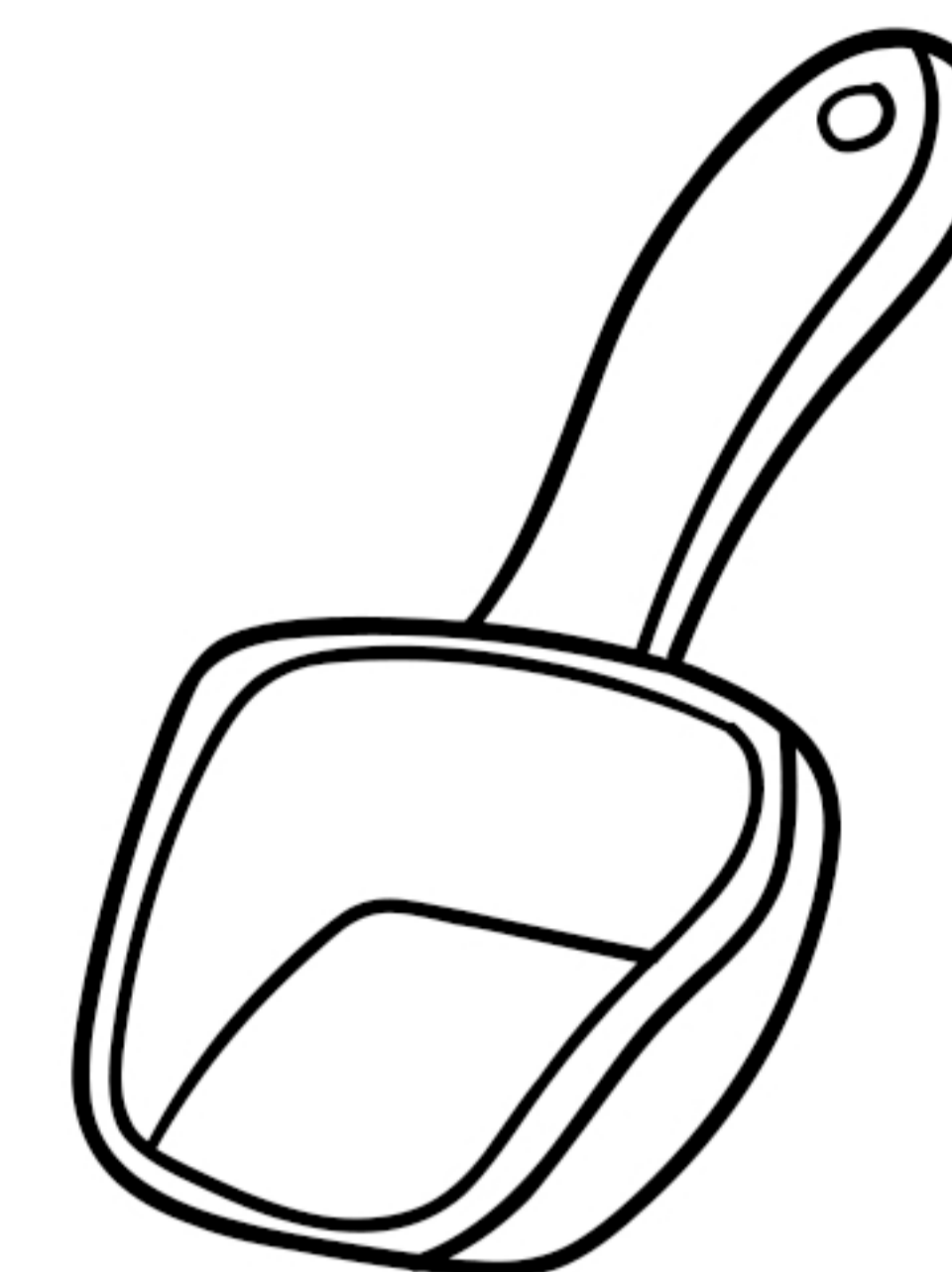

*en skopa*

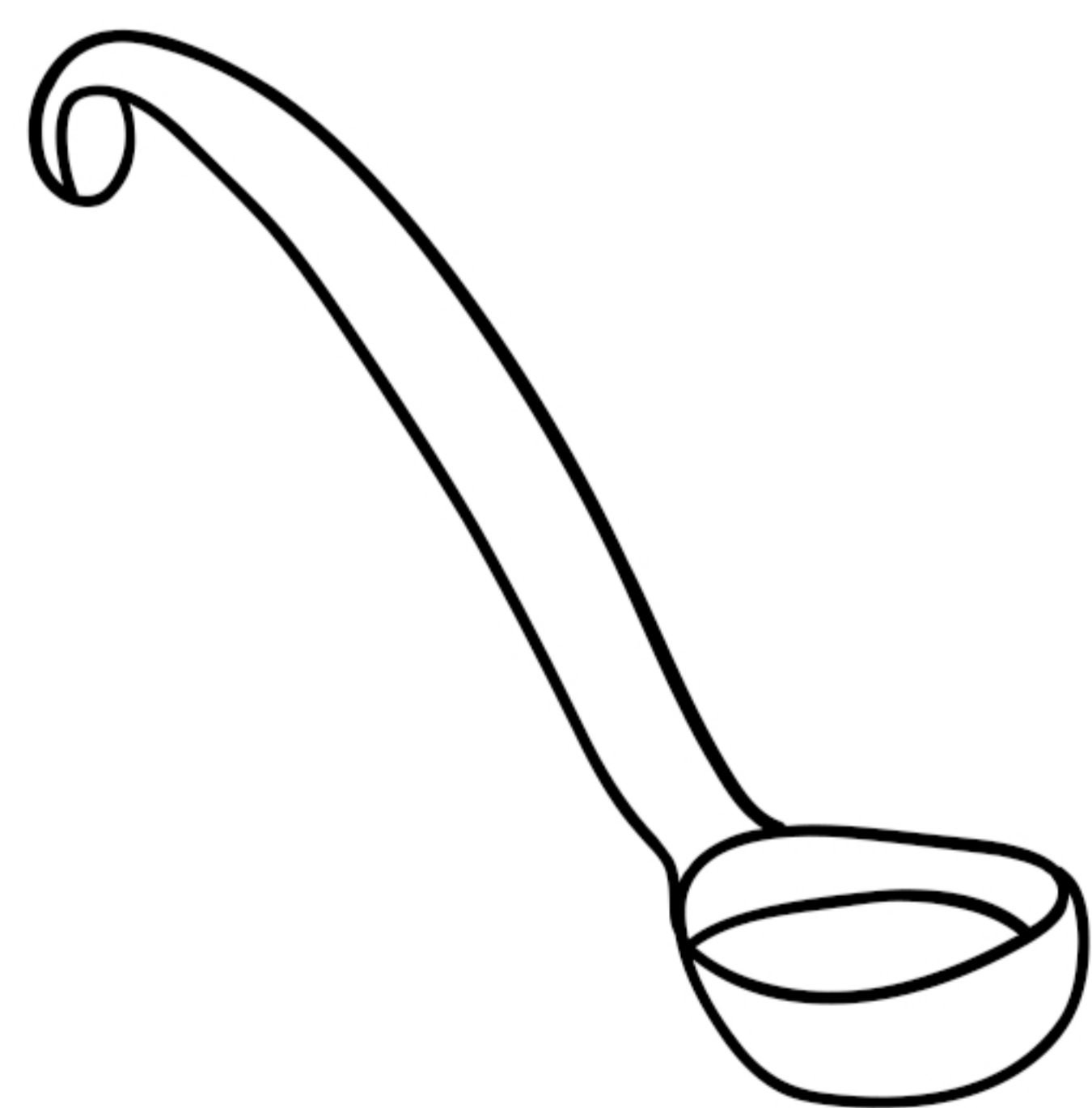

*en soppsked*

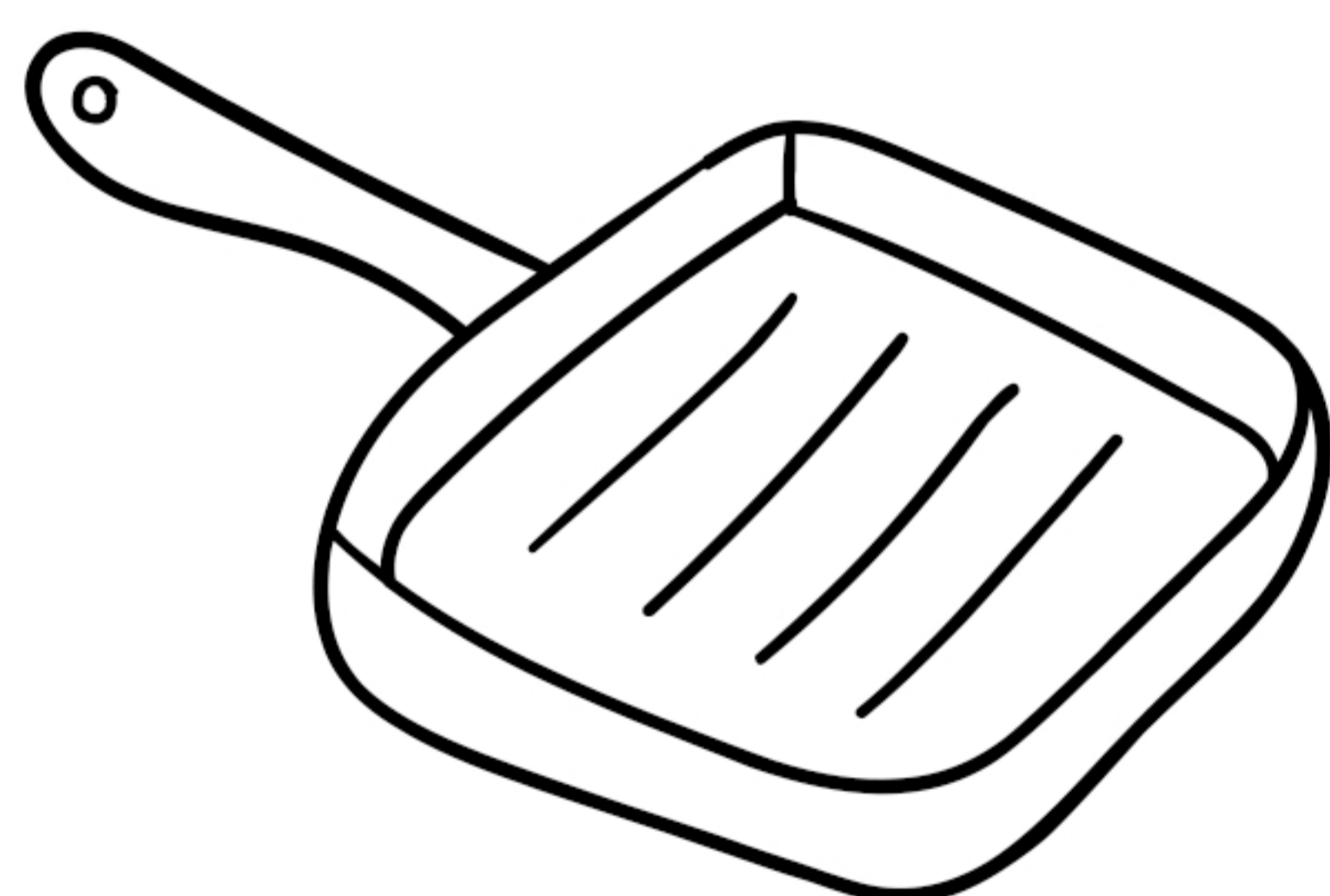

*en grillpanna*

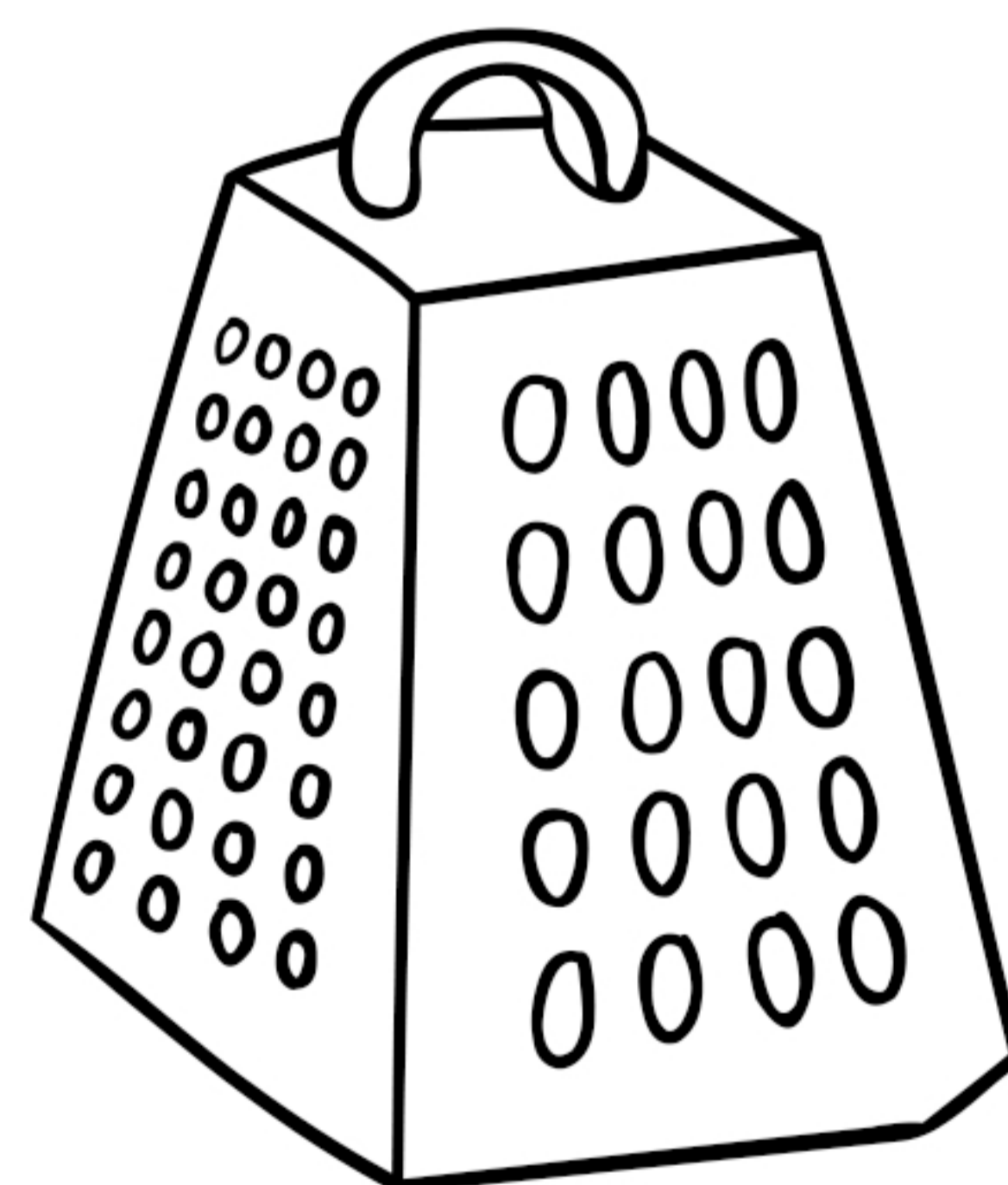

*ett rivjärn*

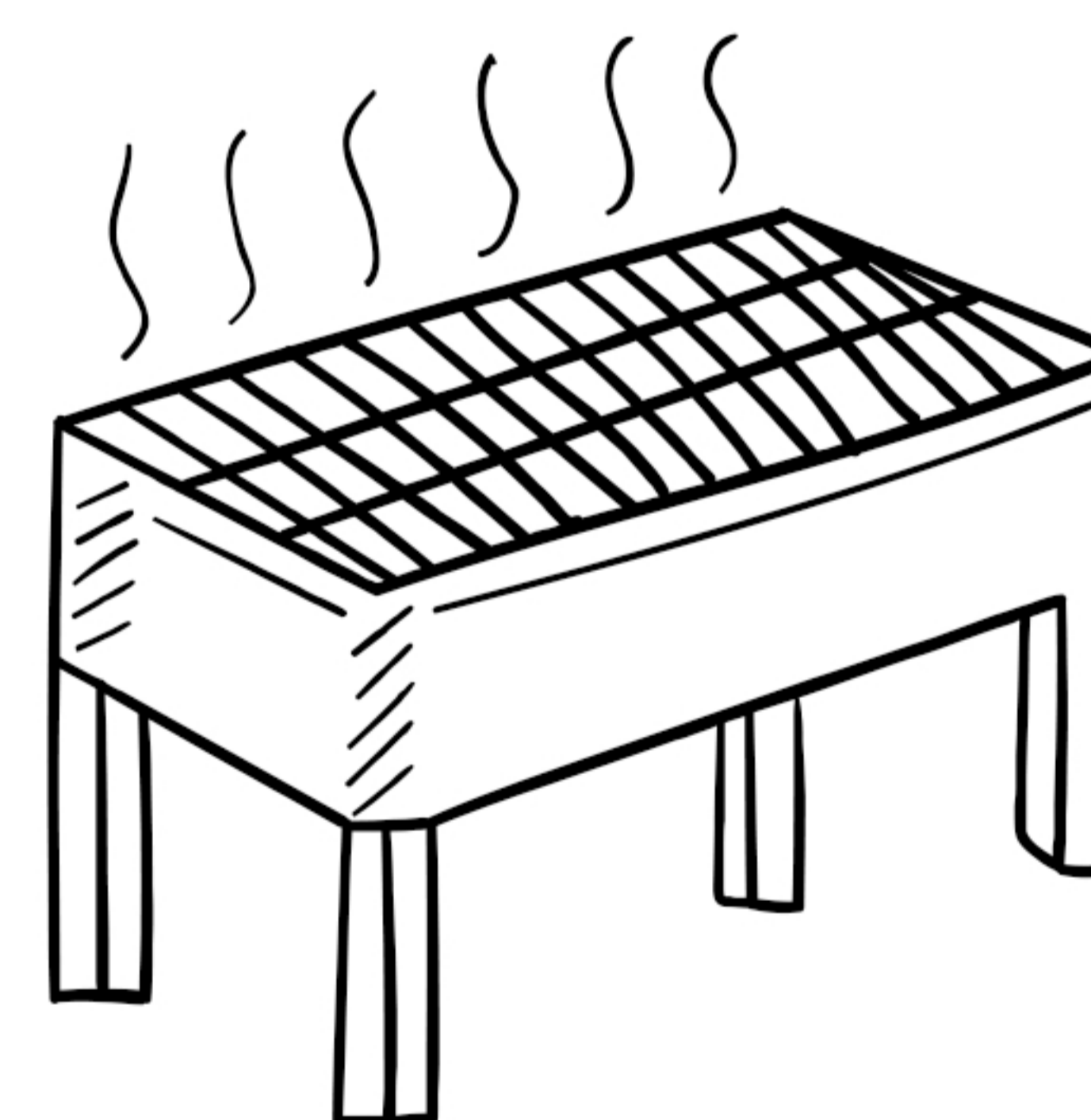

*en grill*

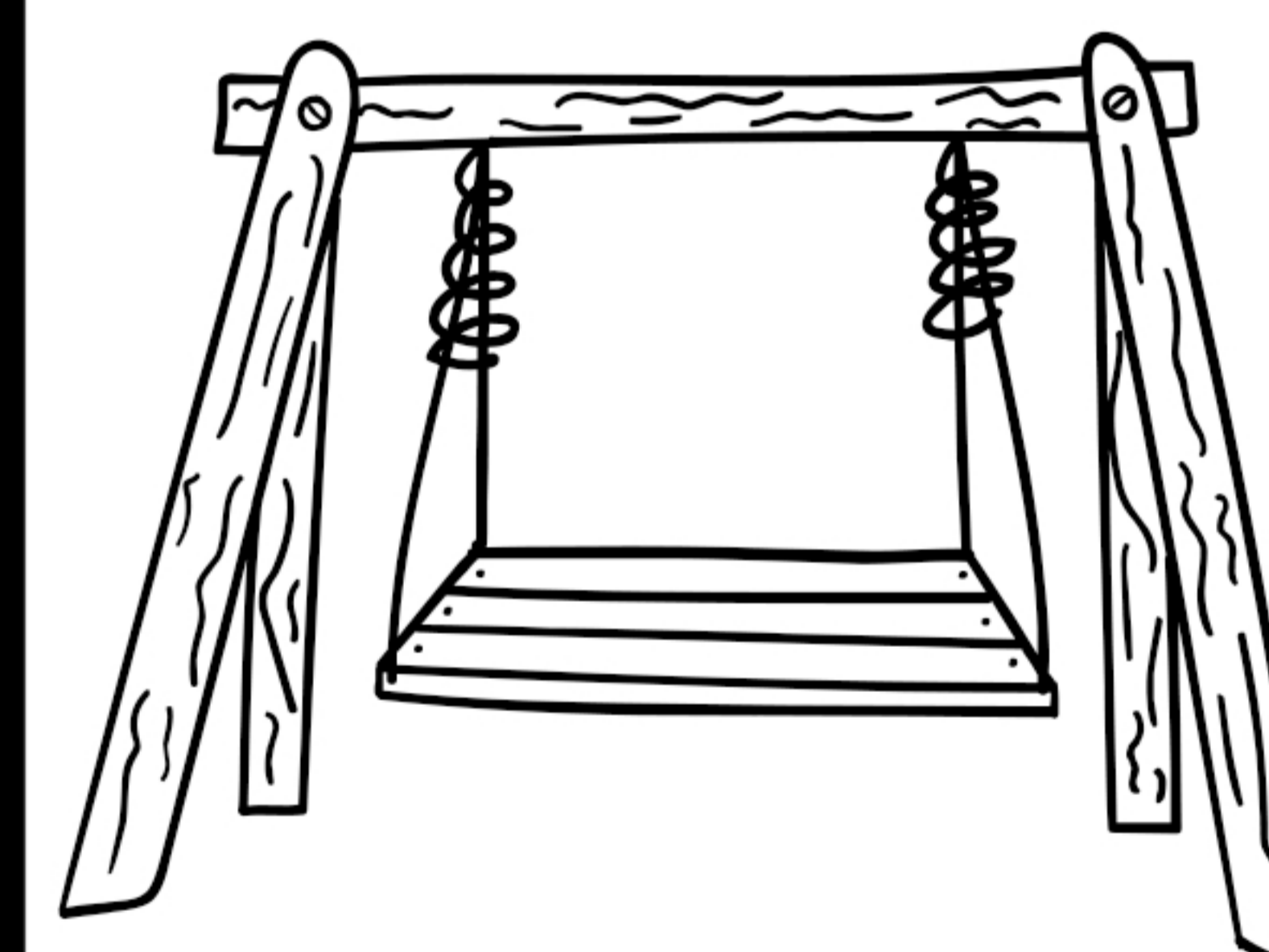

*en gunga*

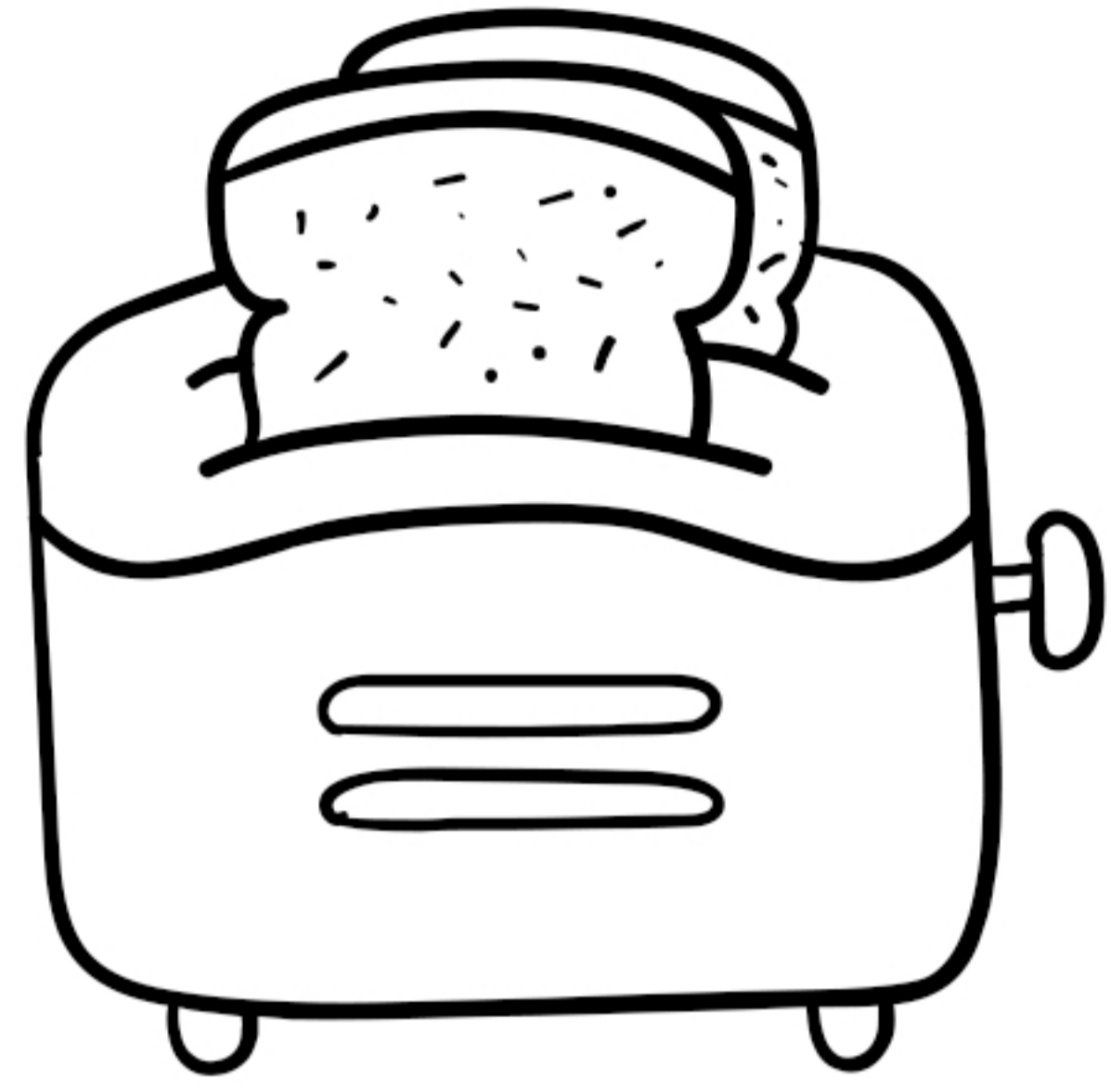

*en brödrost*

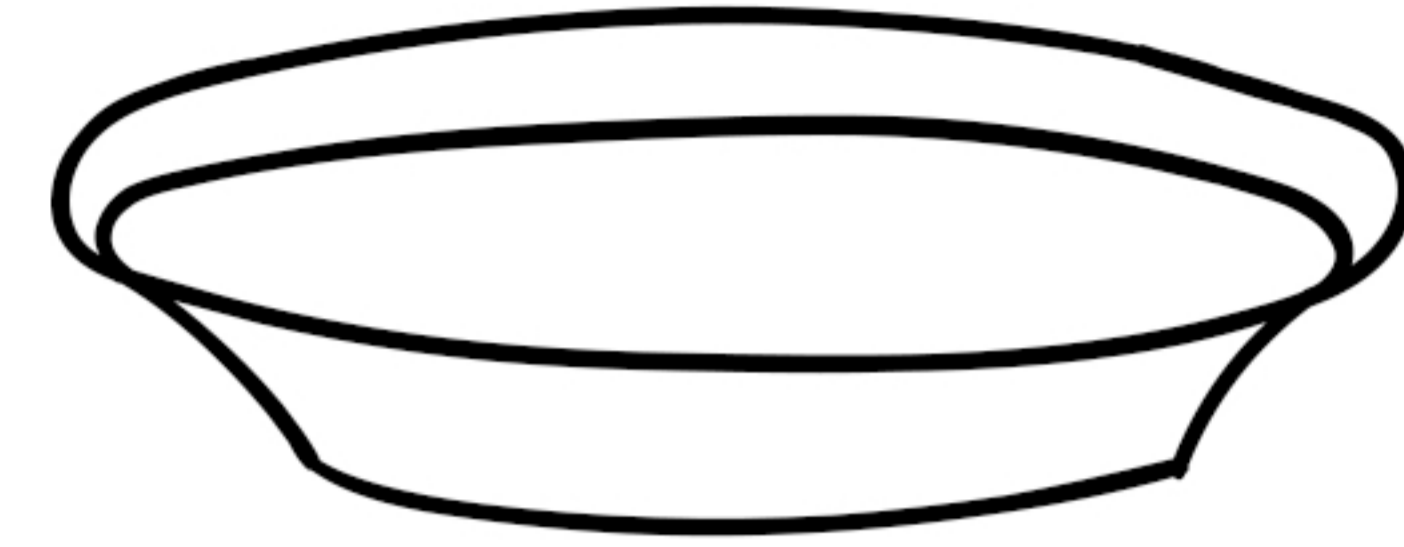

*en skål*

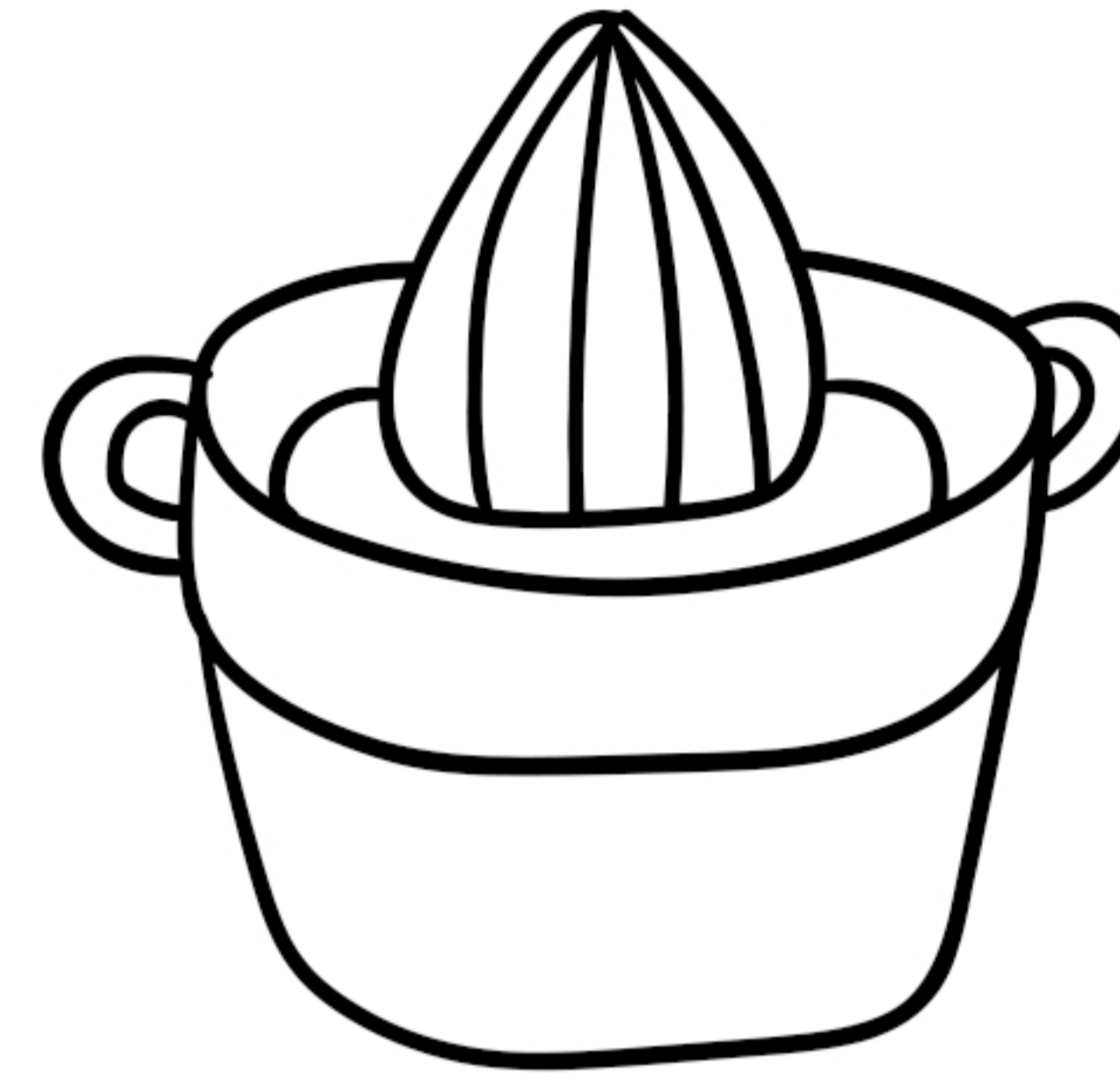

*en citruspress*

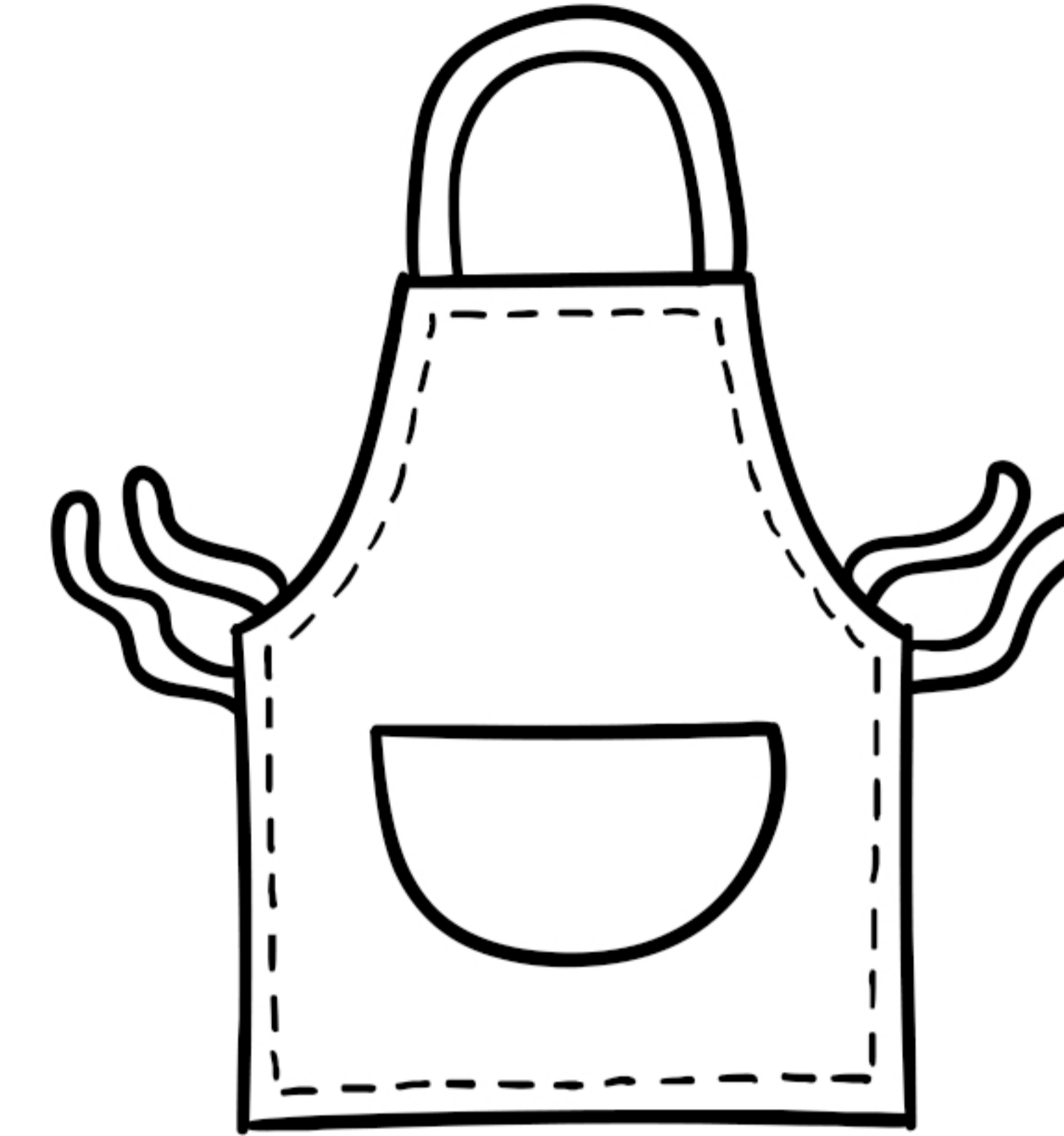

*ett förkläde*

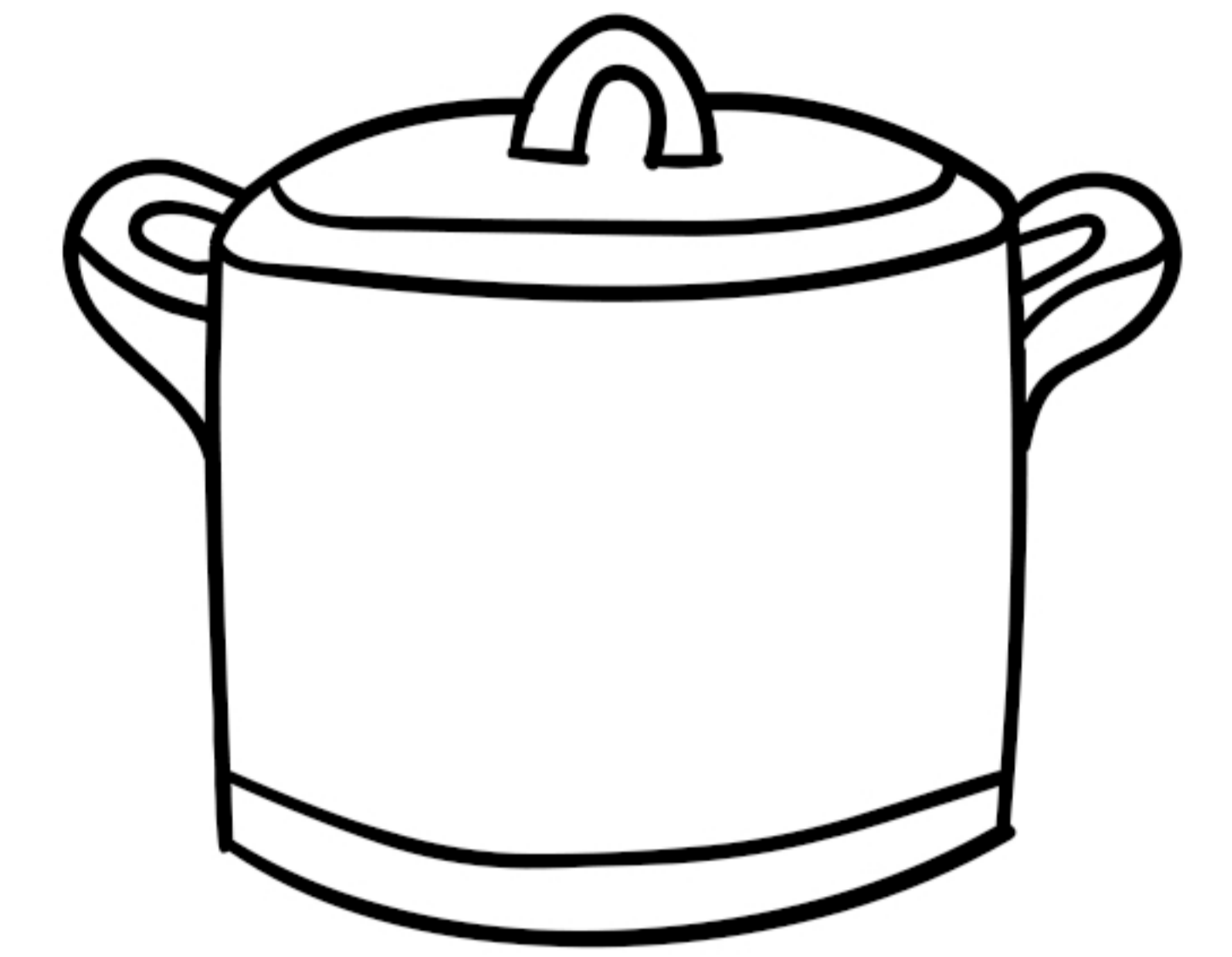

*en gryta*

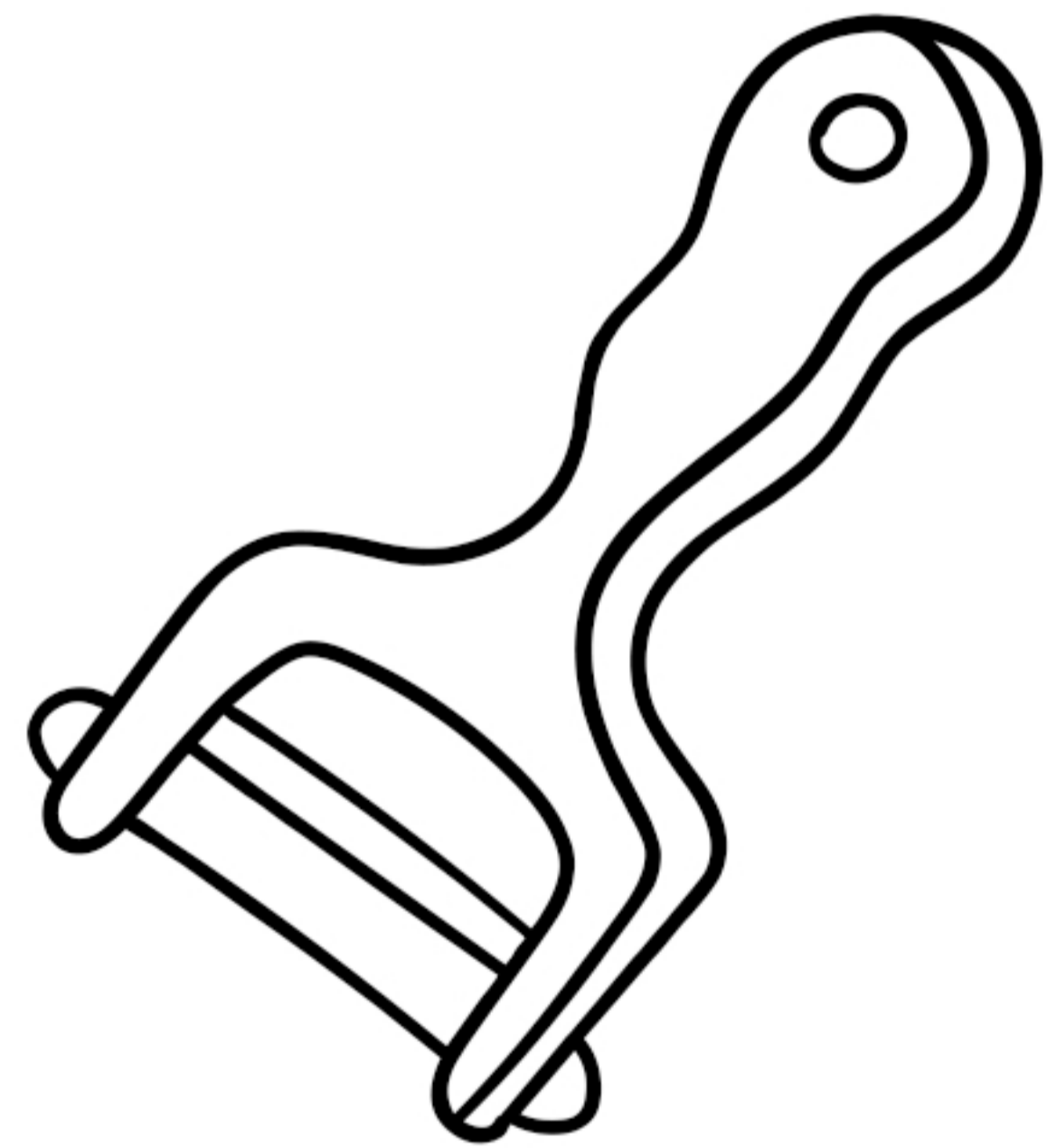

*en skalare*

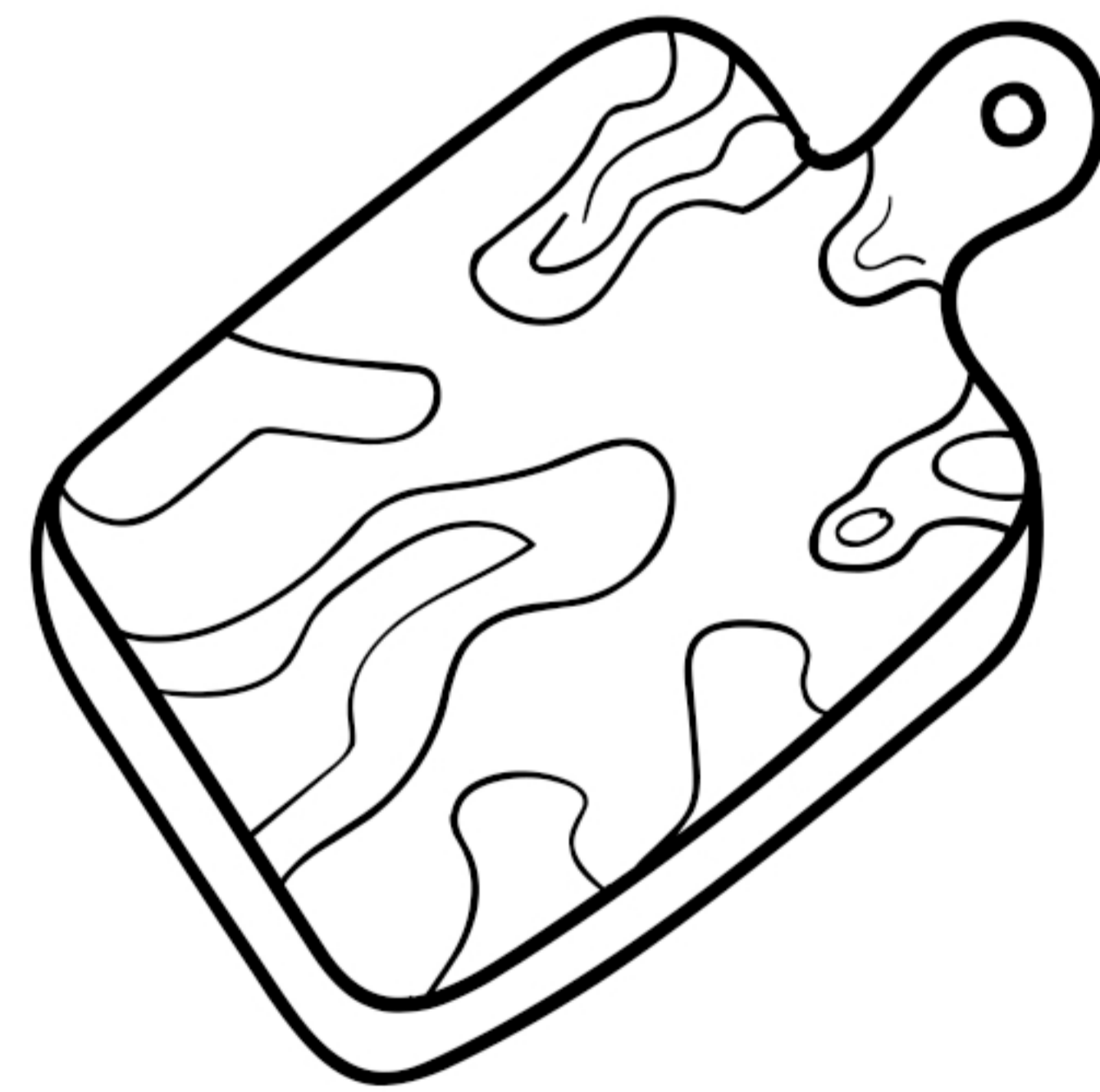

*en skärbräda*

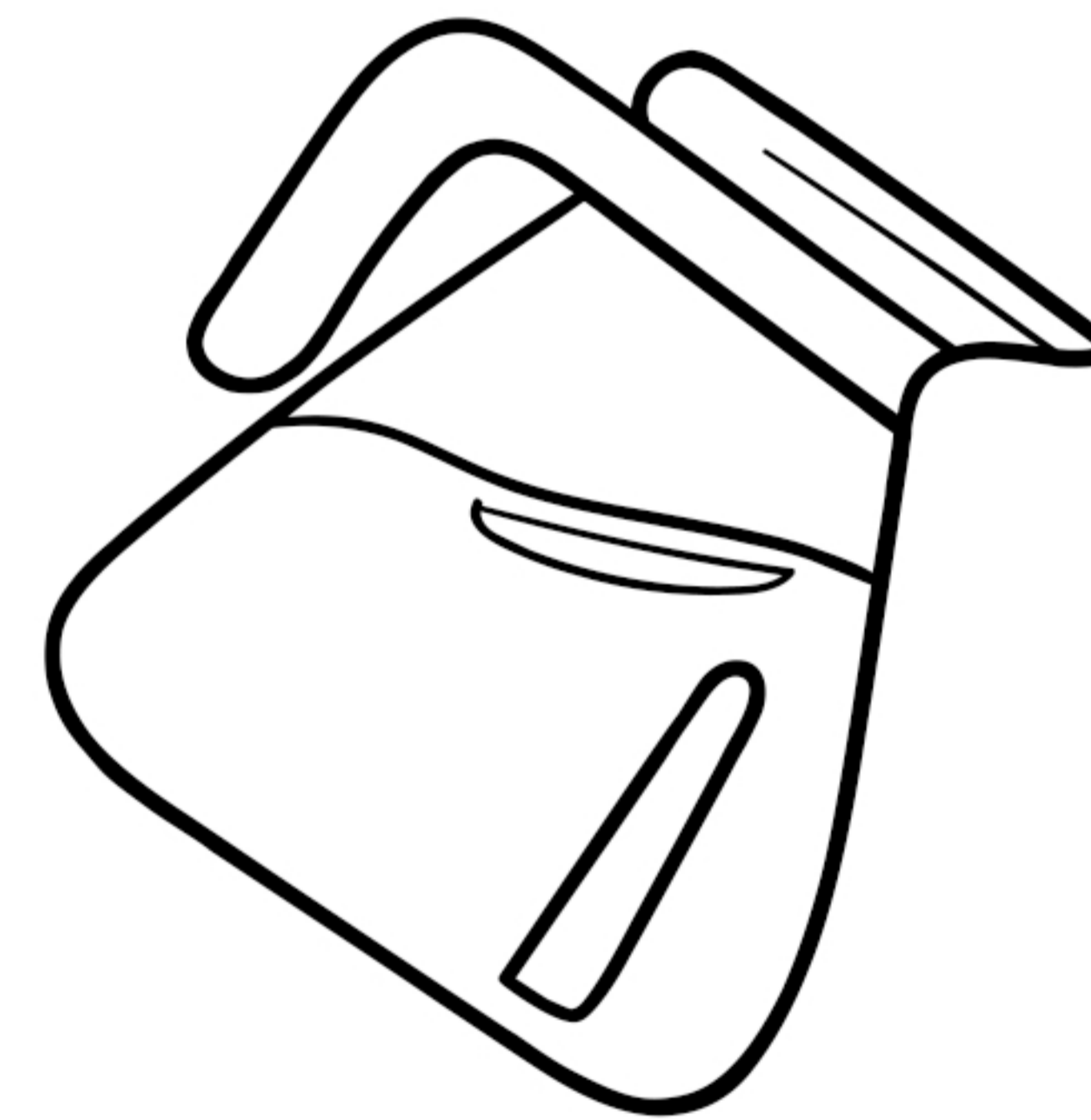

*en kaffekanna*

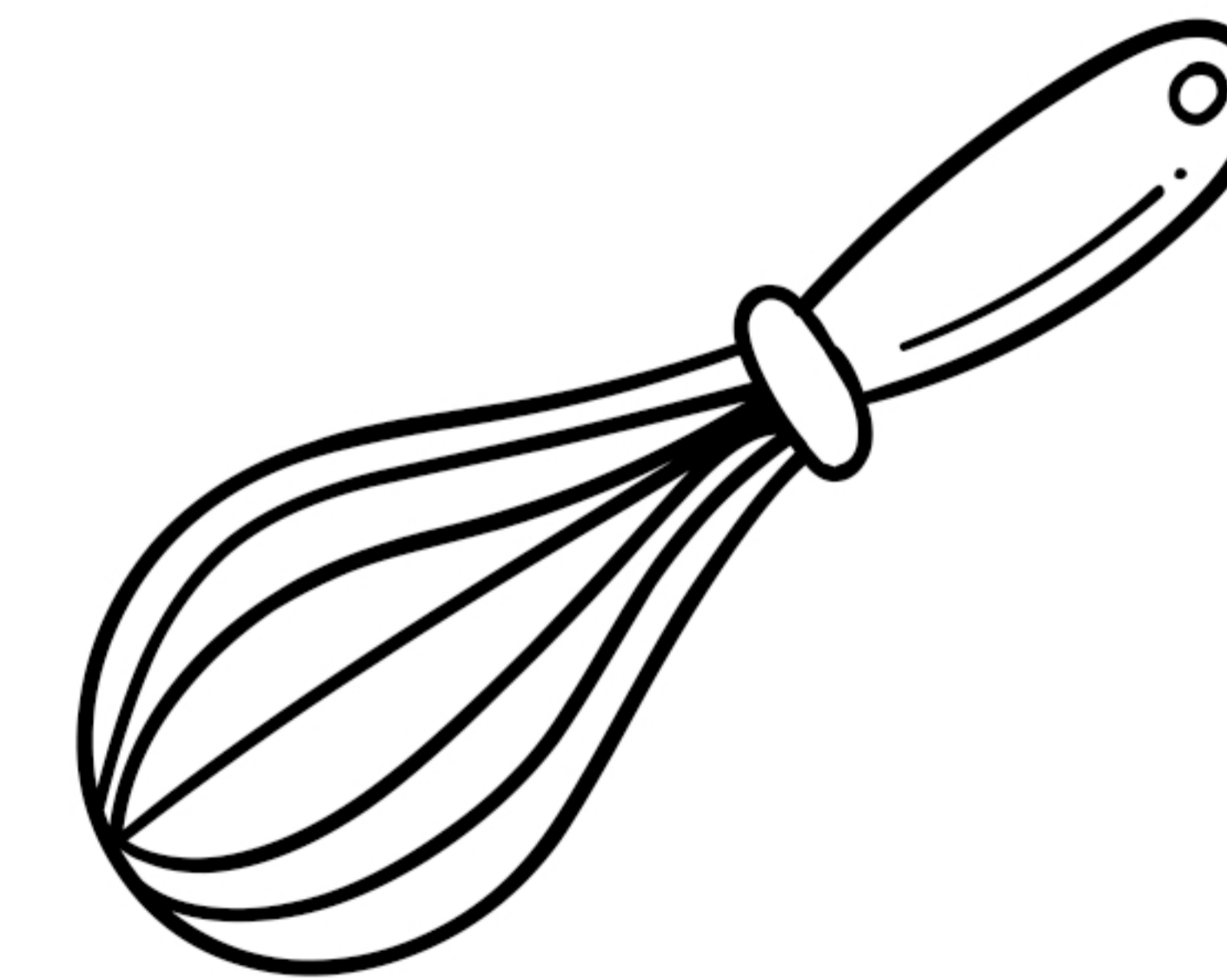

*en ballongvisp*

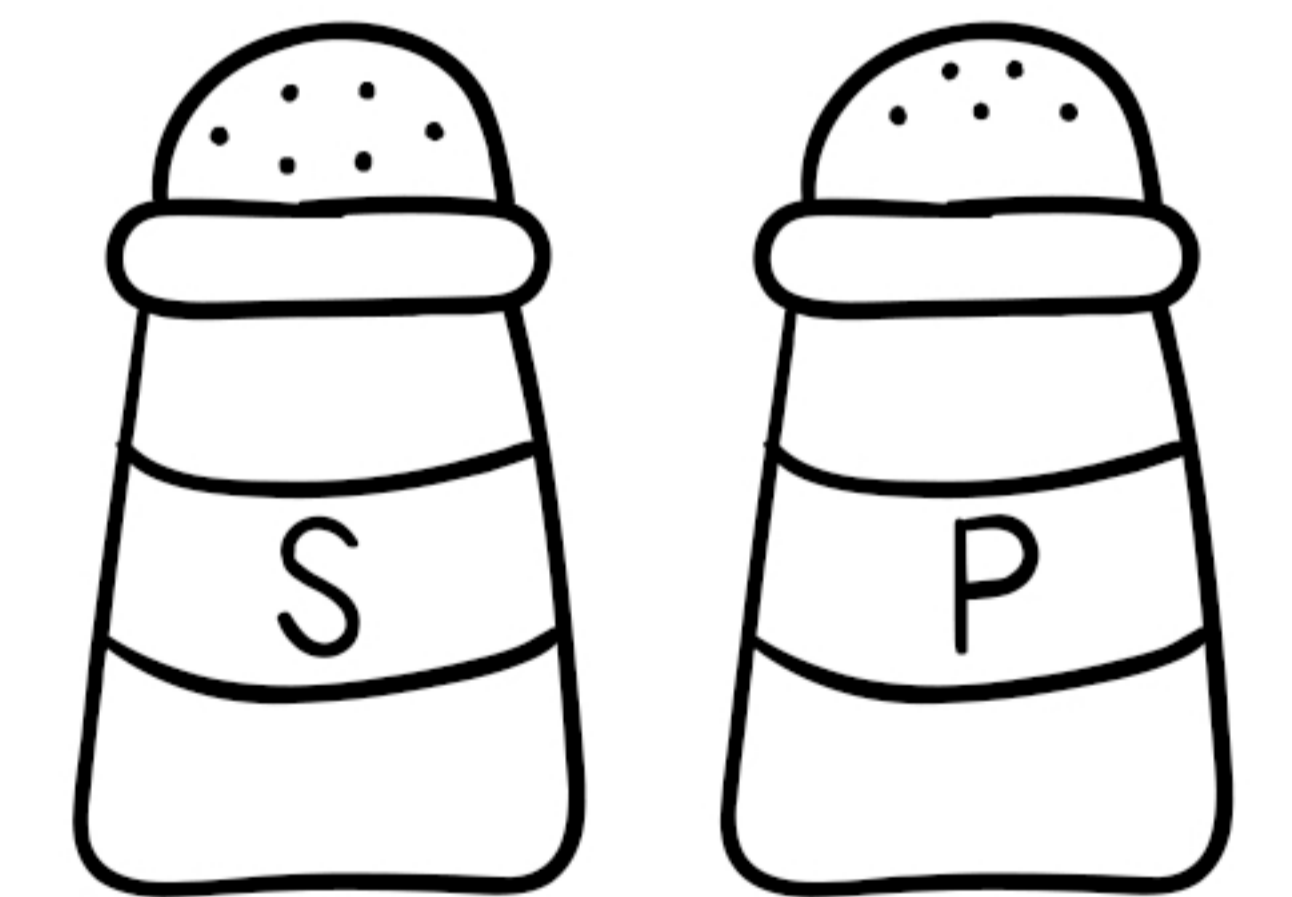

*salt- och pepparströare*



*en tekanna*

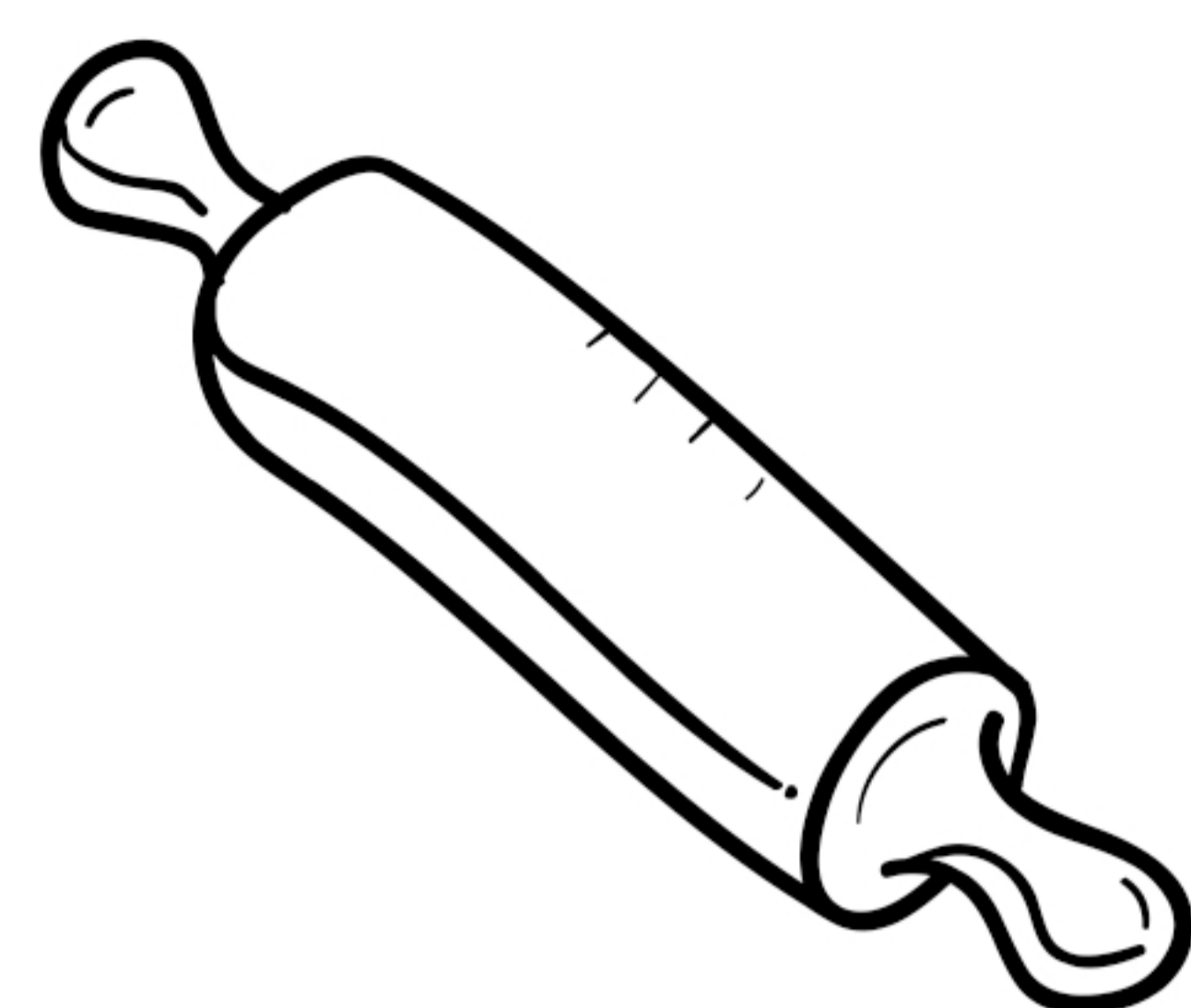

*en kavel*

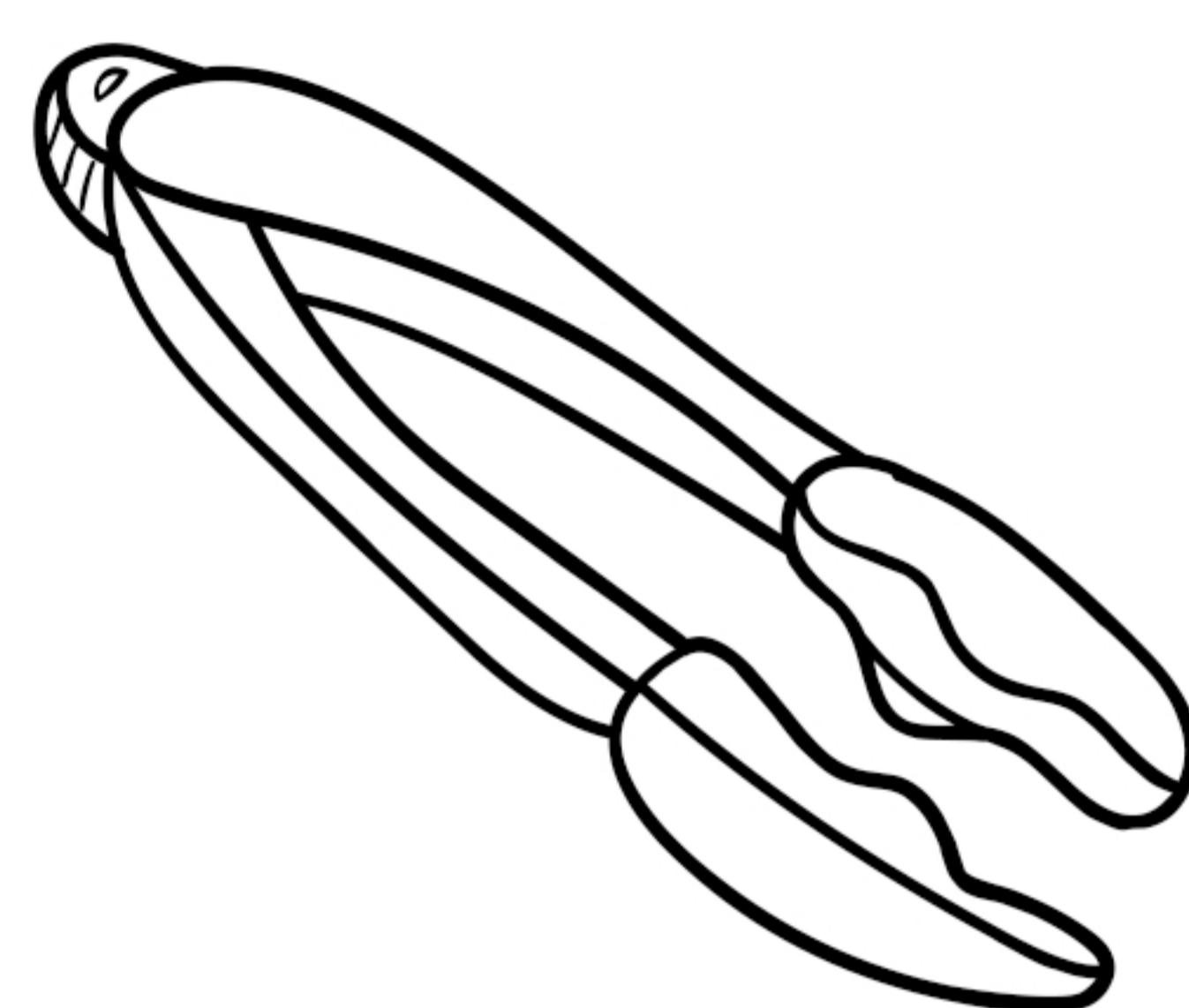

*en nötknäckare*

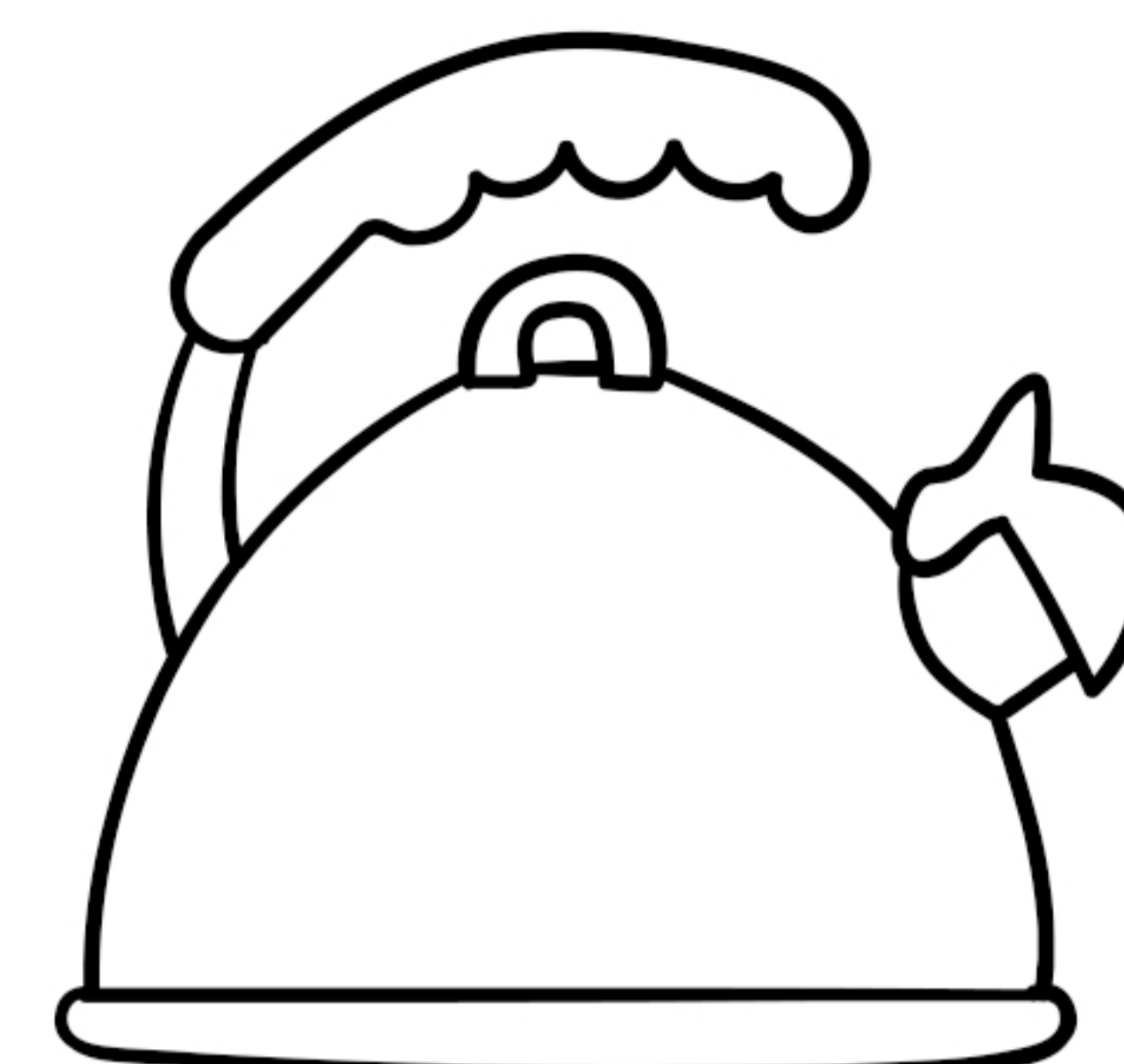

*en vattenkittel*



*en kastrull*

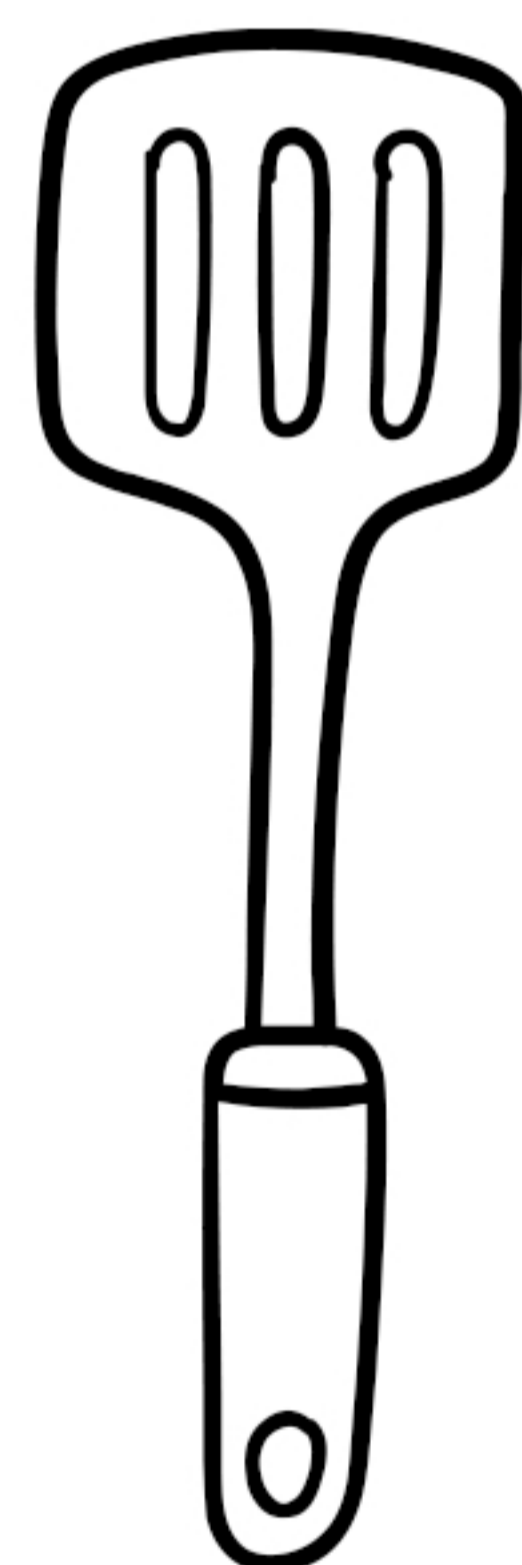

*en stekspade*



*en degblandare*

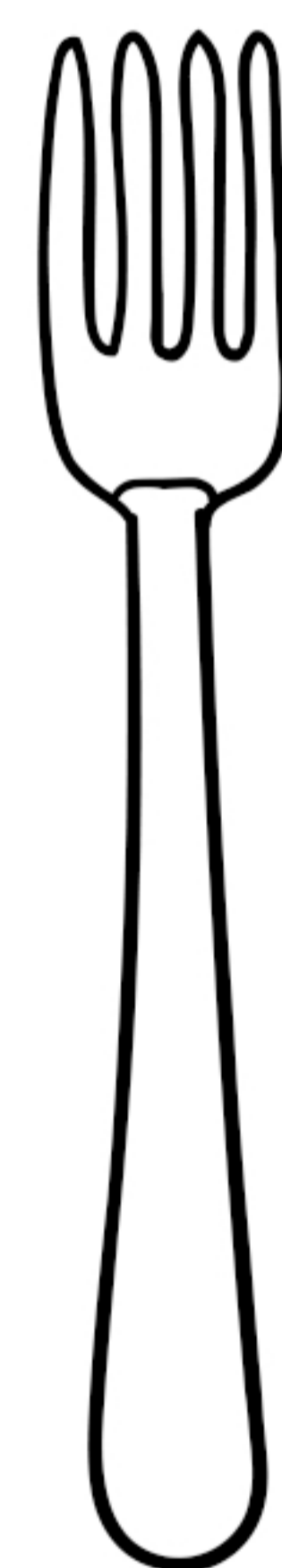

*en trägaffel*



*en kökskniv*

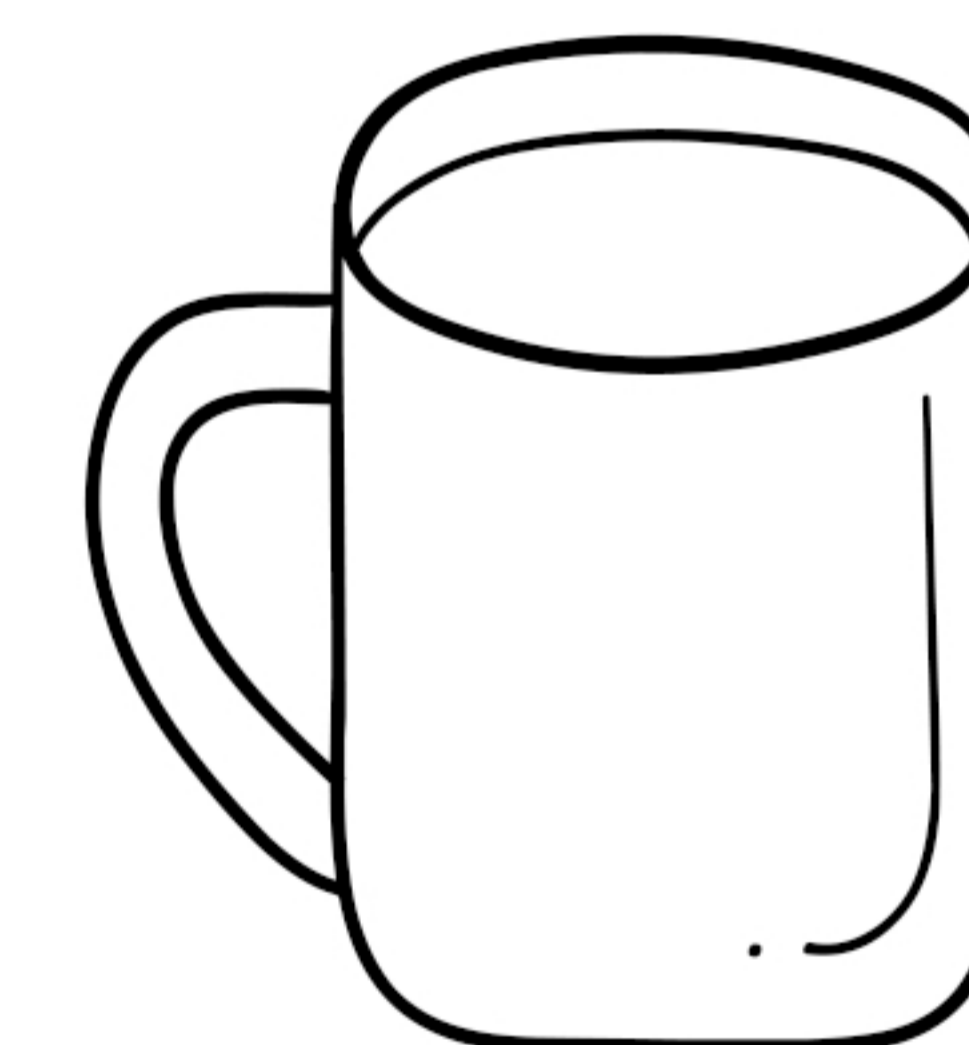

*en mugg*

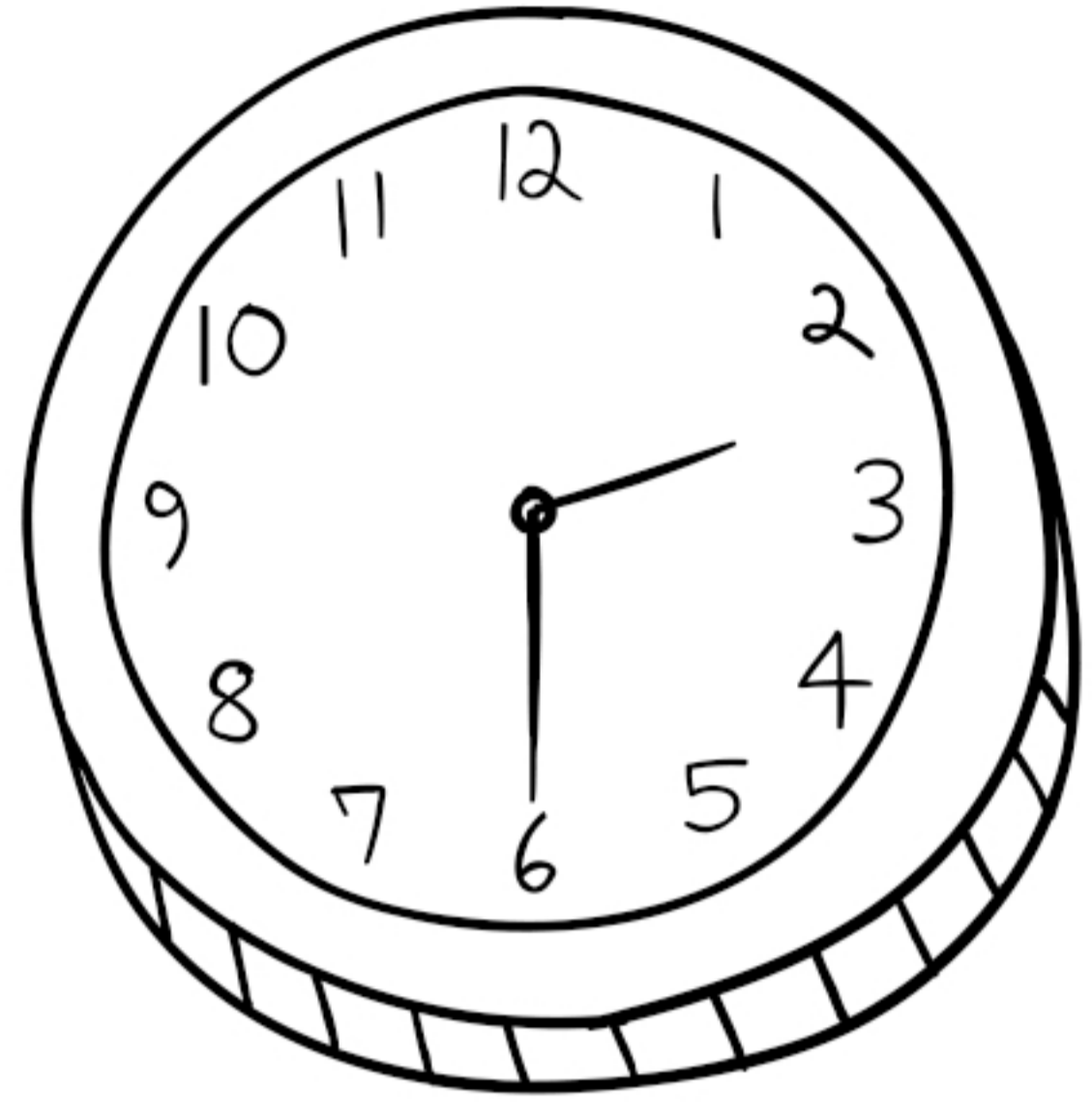

*en väggklocka*

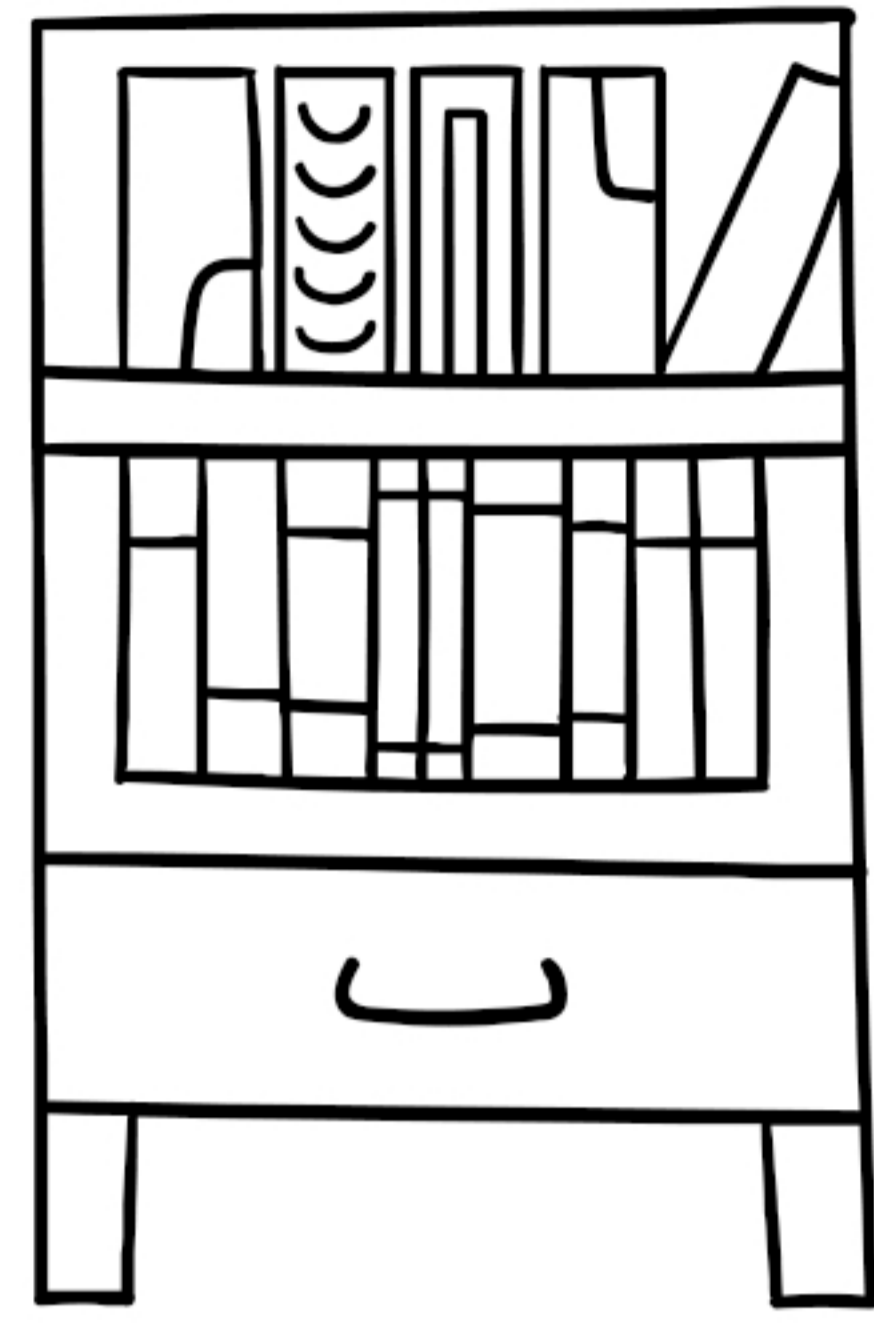

*en bokhylla*

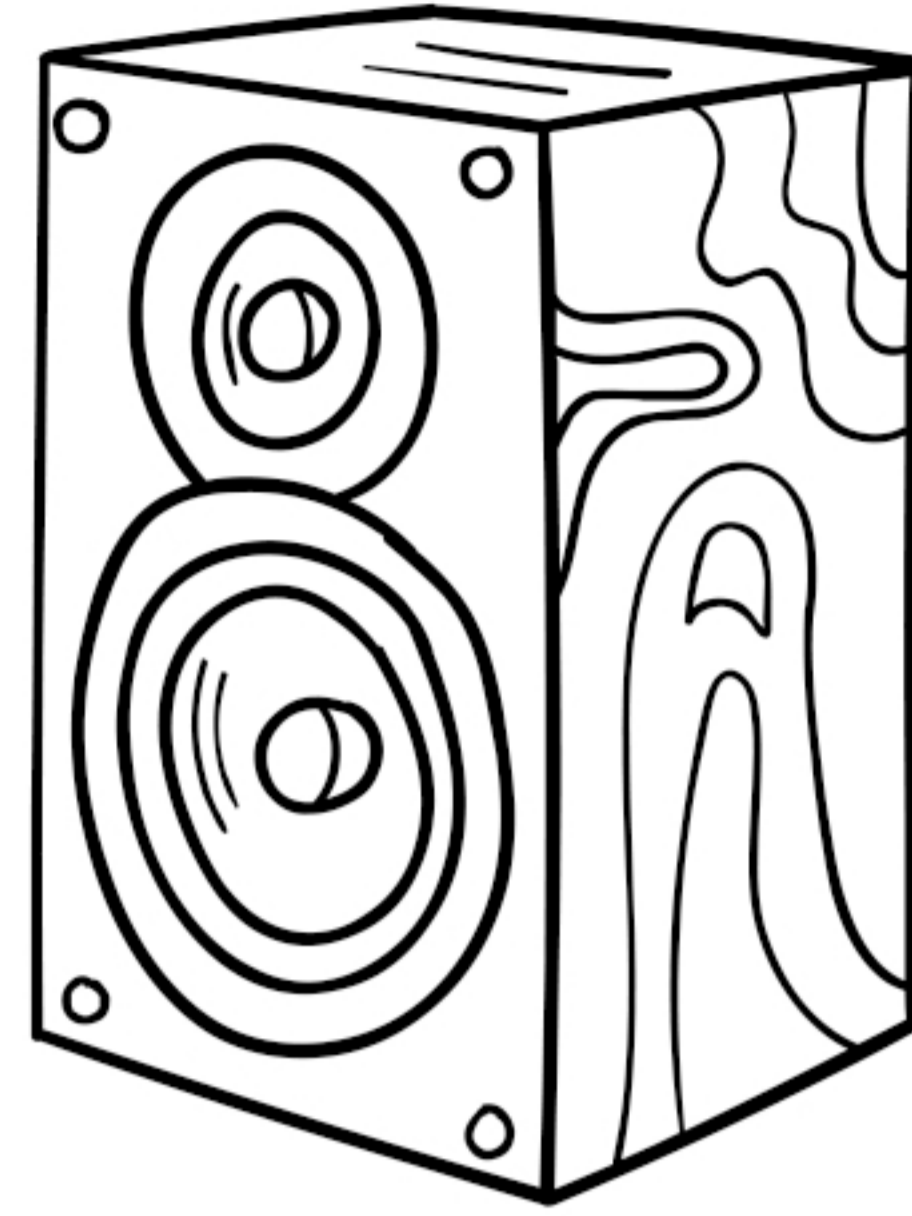

*en högtalare*

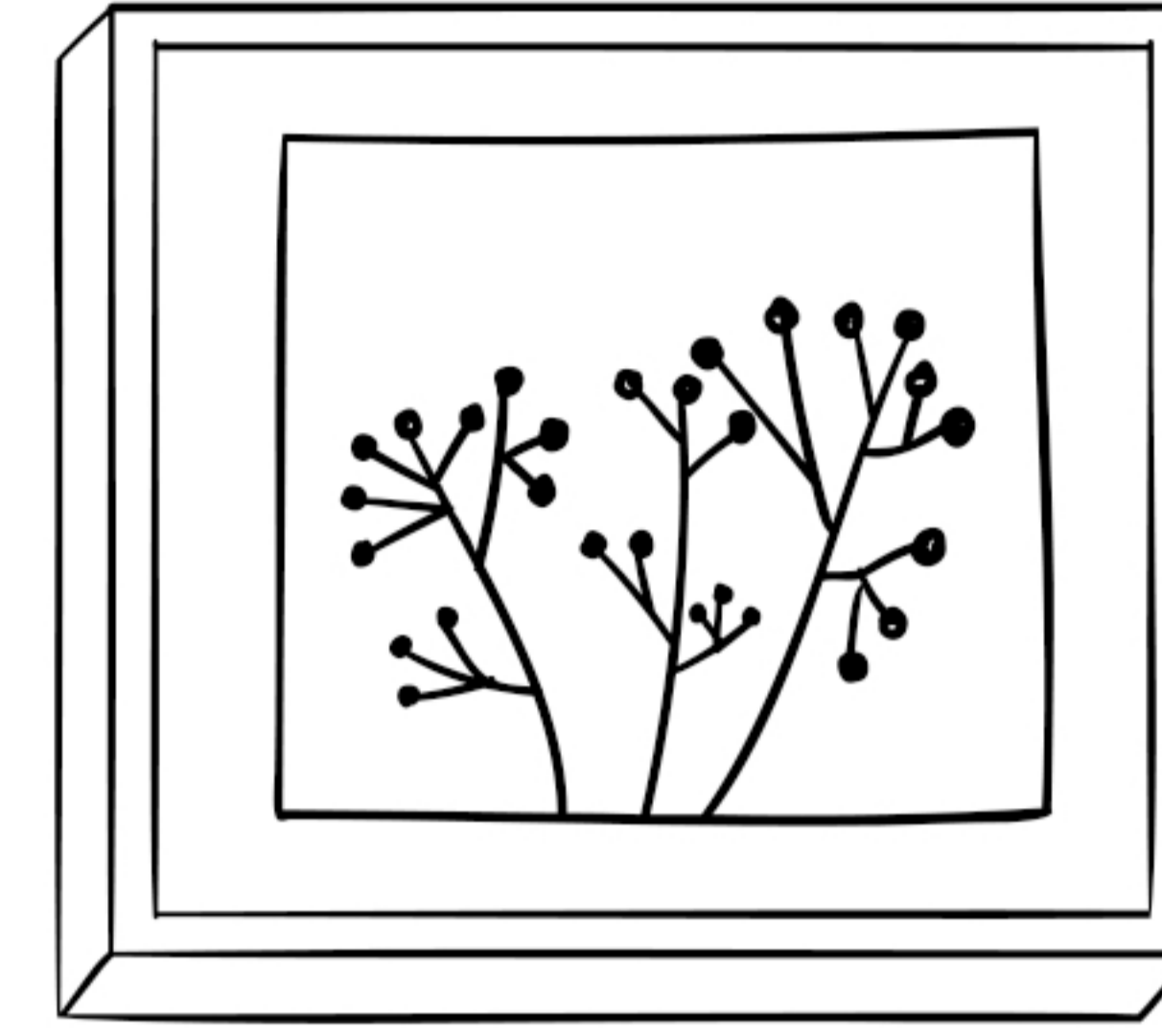

*en tavla*

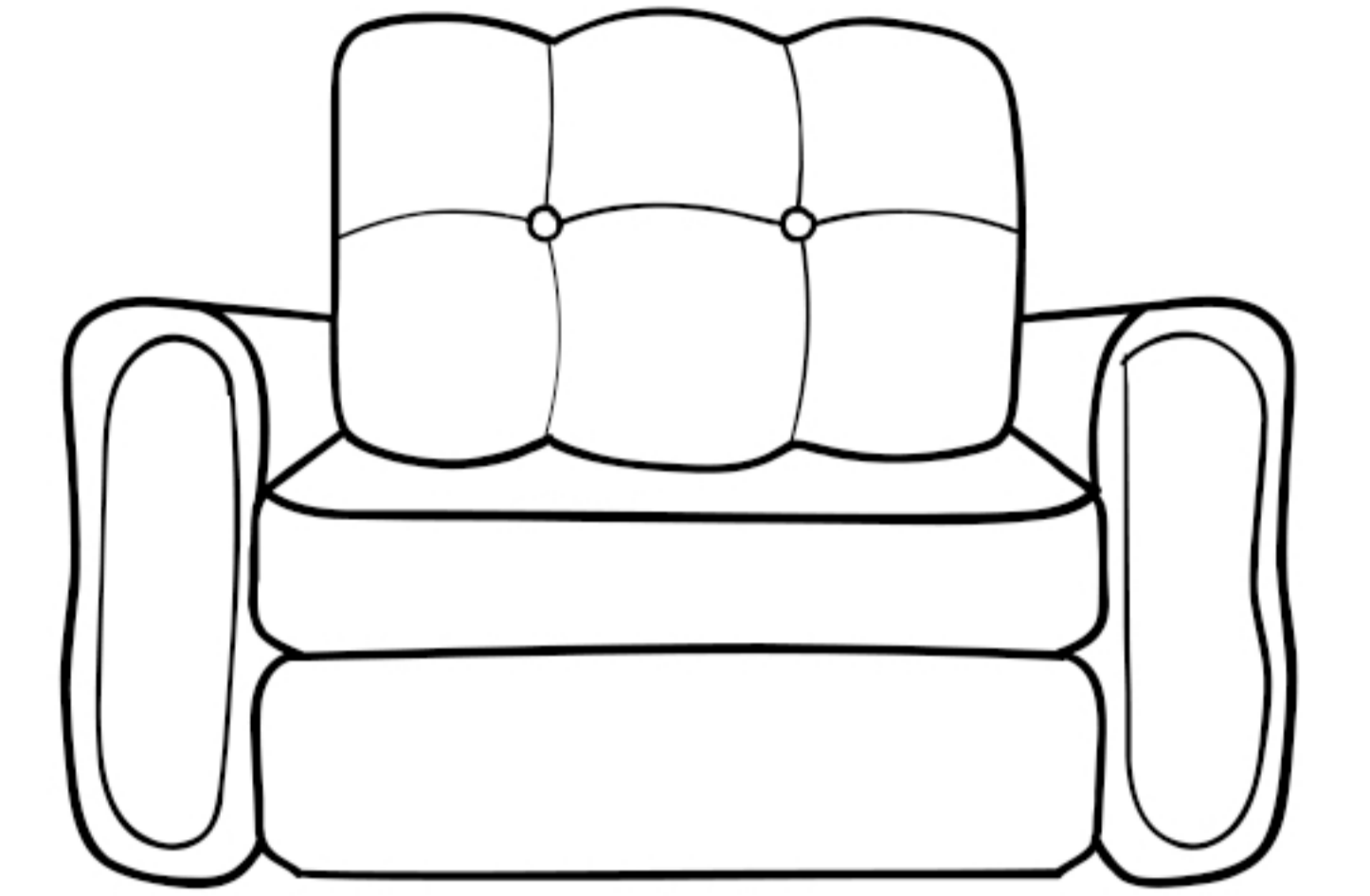

*en fåtölj*



*en blender*

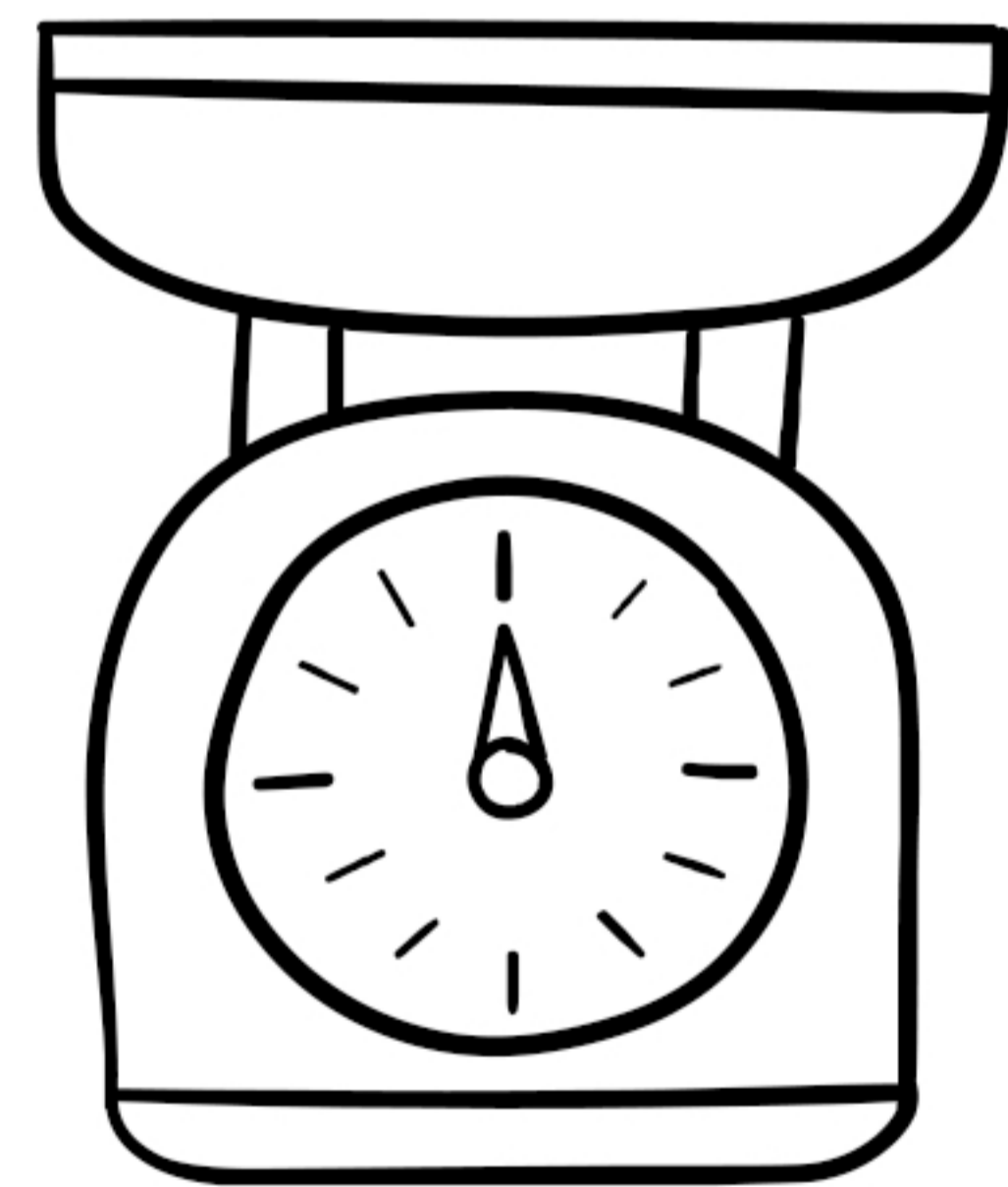

*en köksvåg*

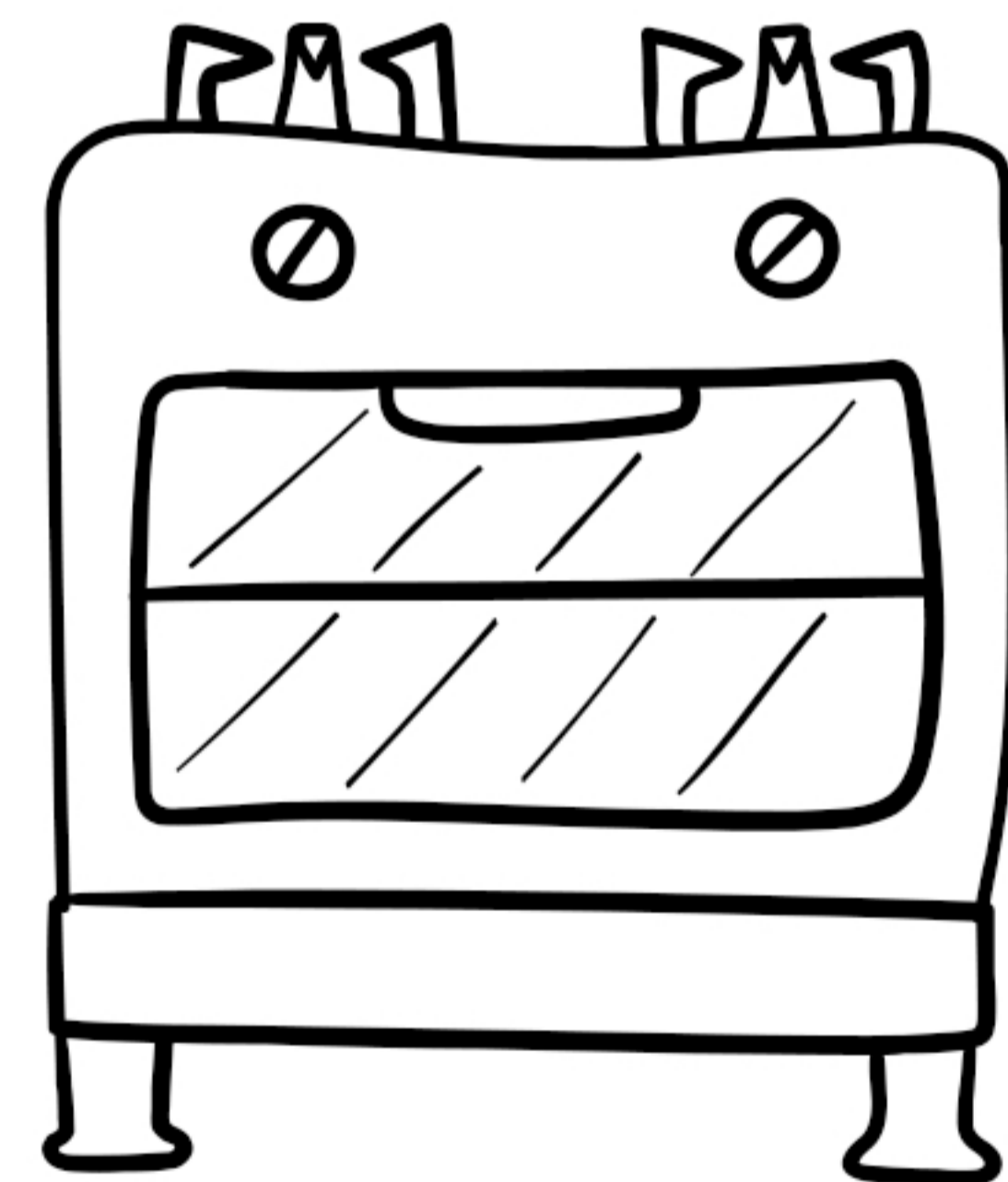

*en spis*

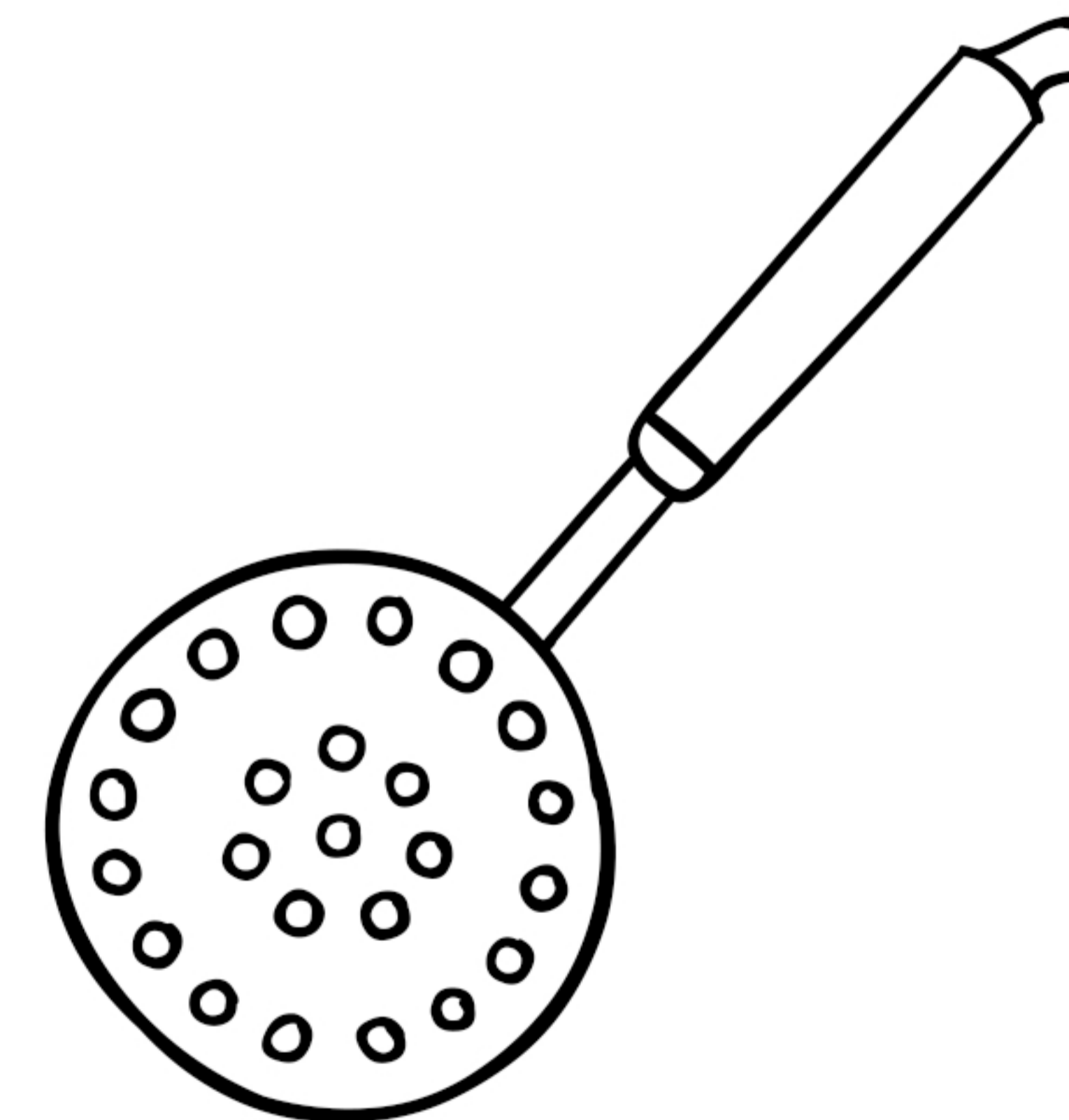

*en hålslev*

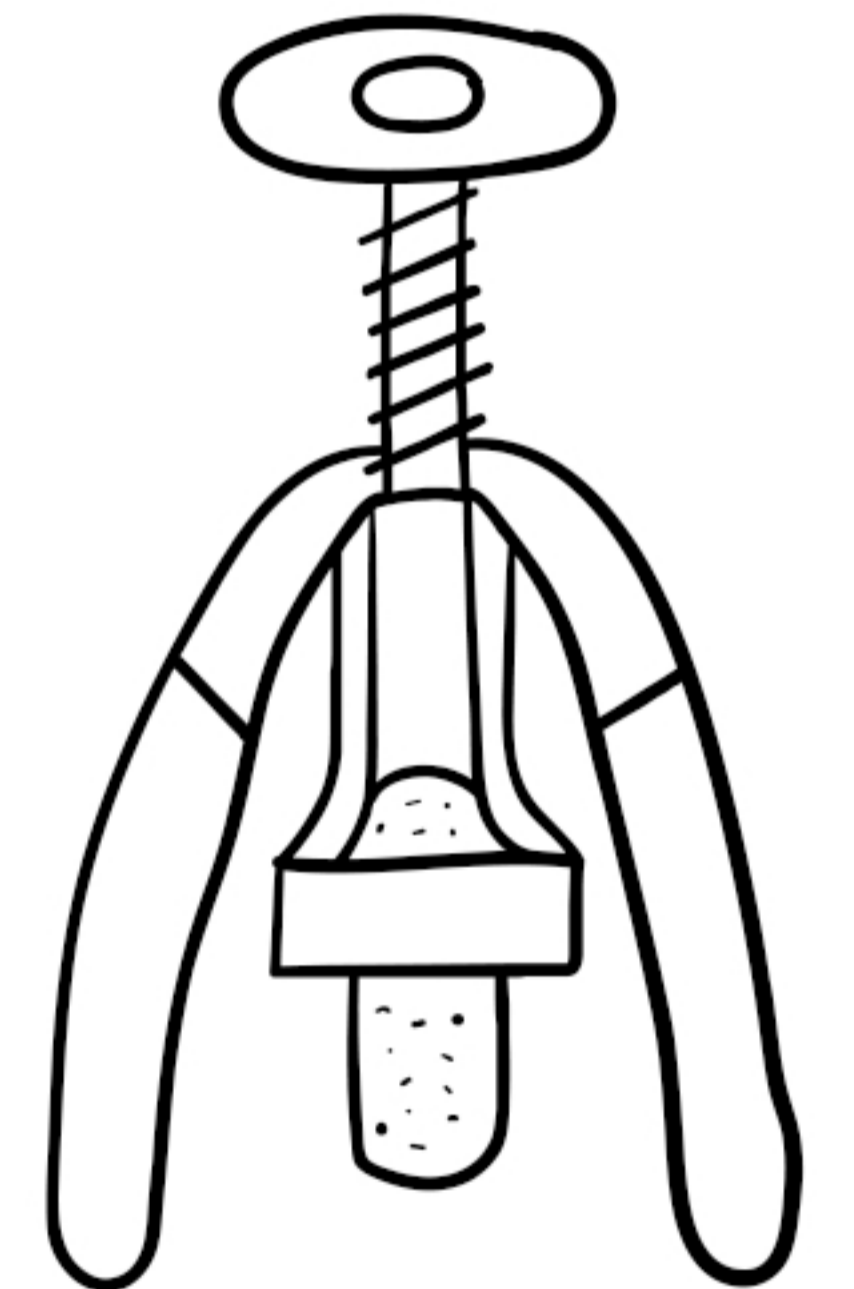

*en korkskruv*



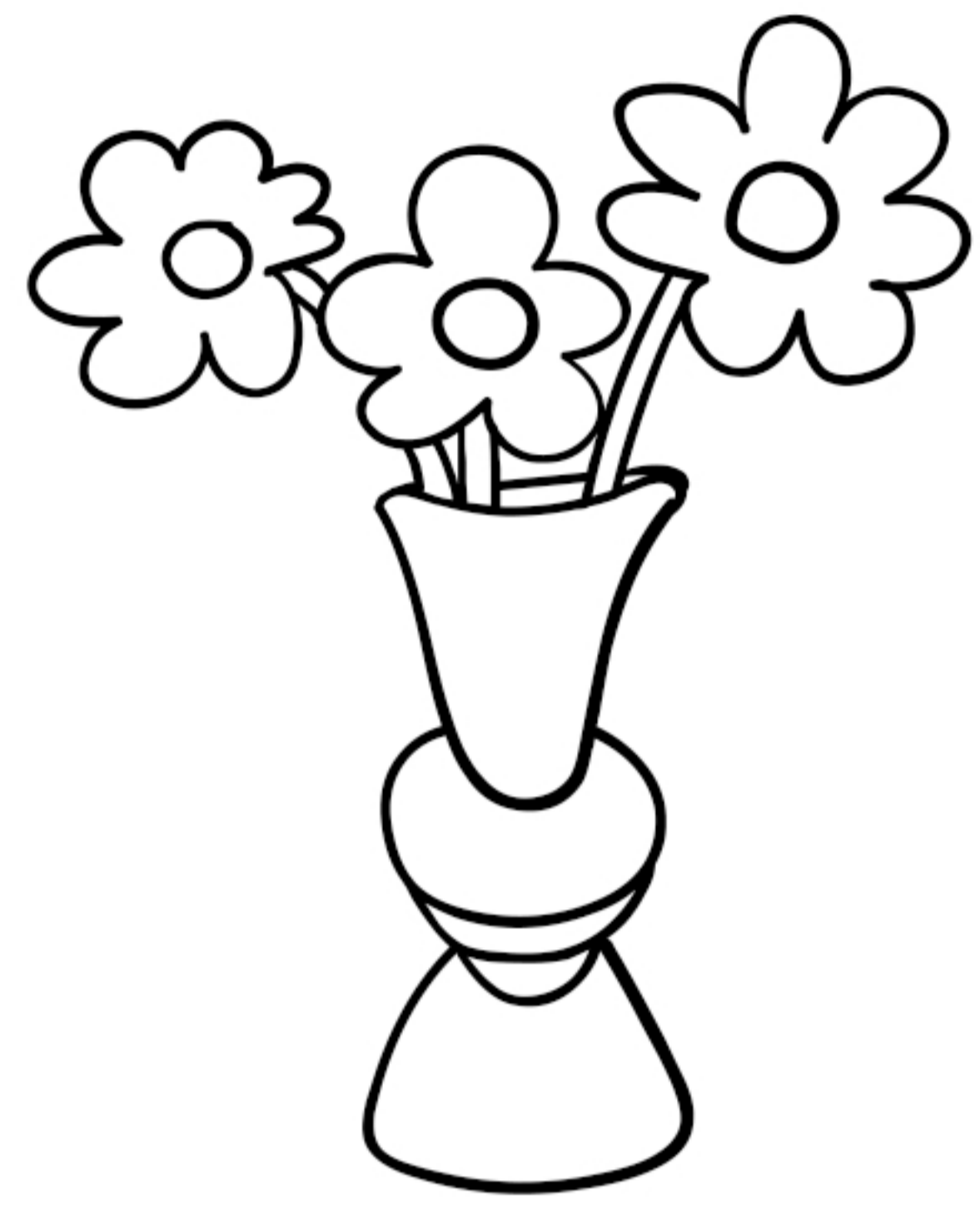

*en blomvas*

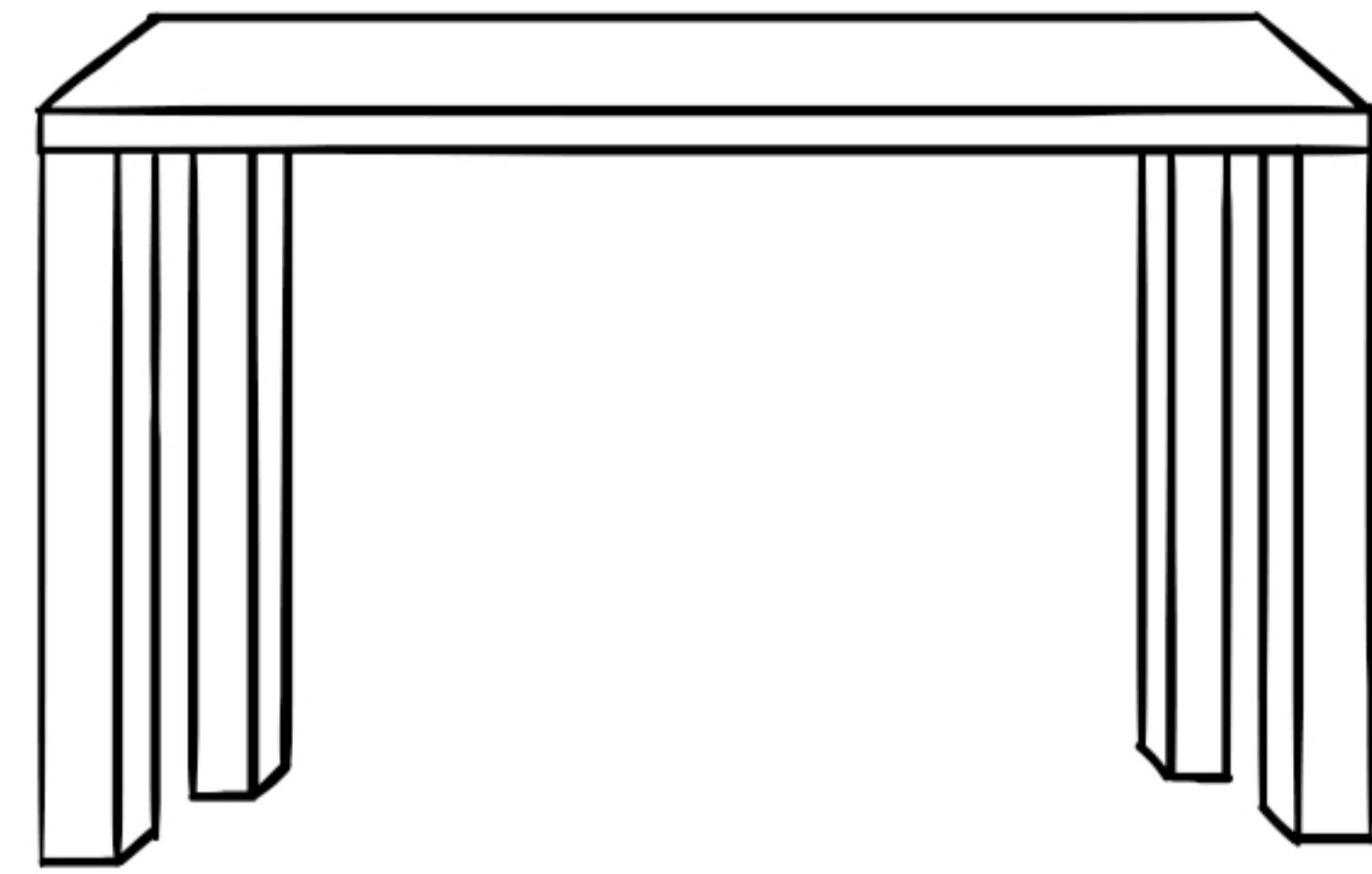

*ett soffbord*



*en krukväxt*

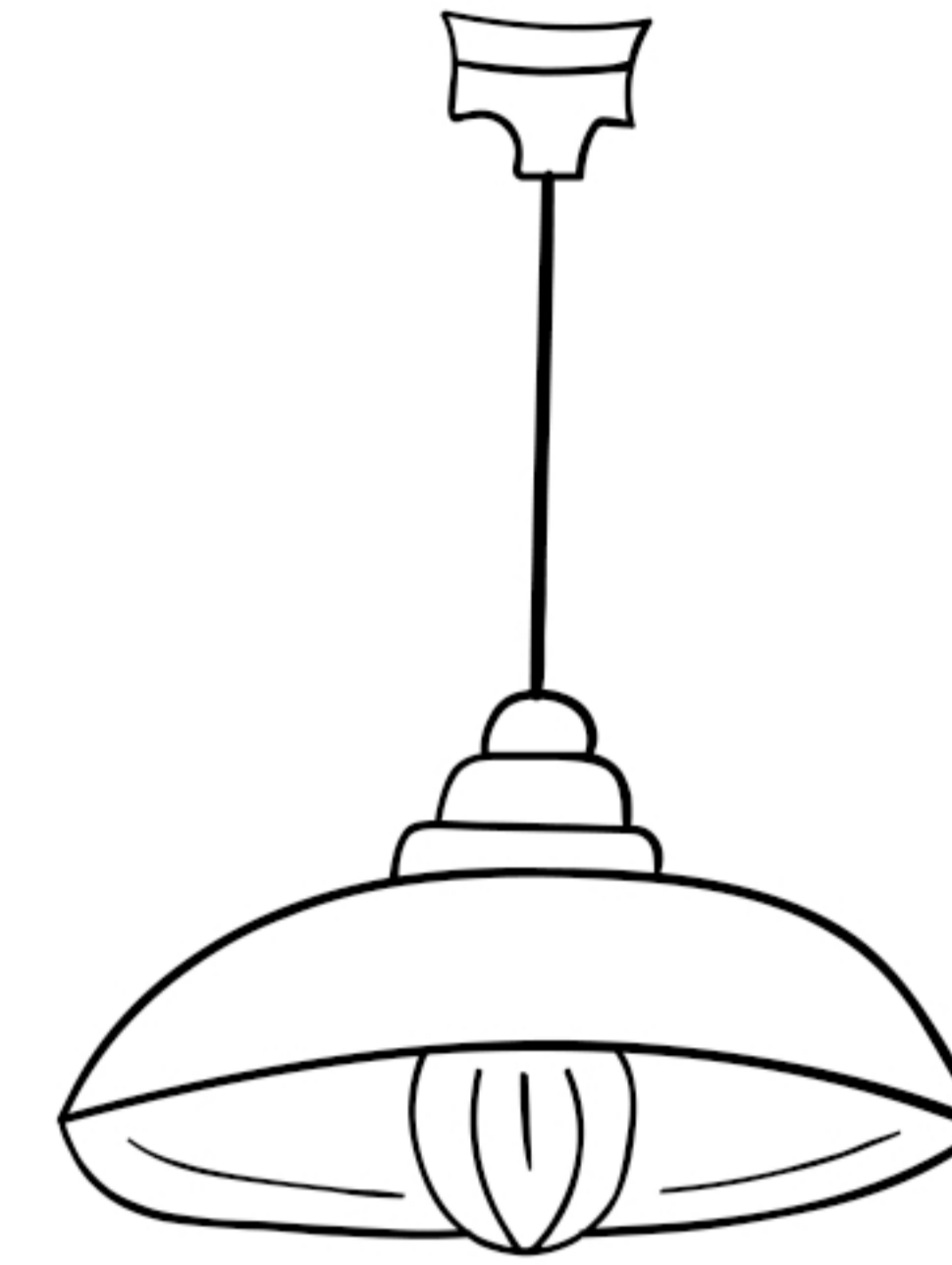

*en taklampa*

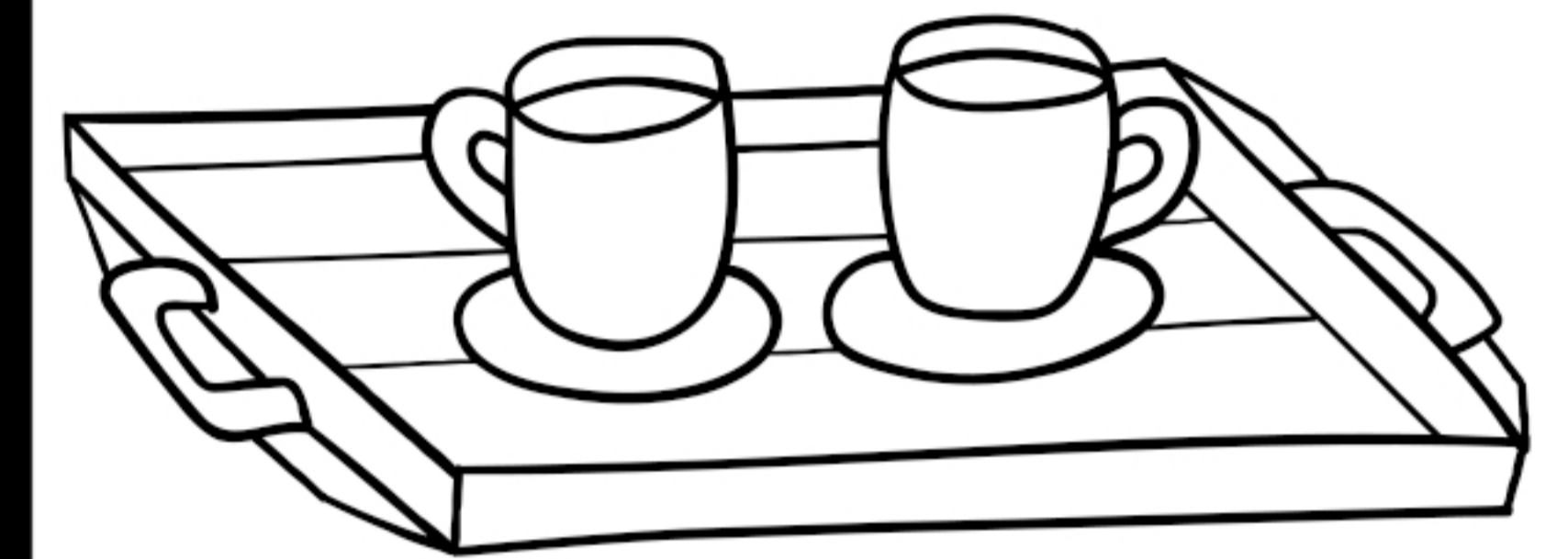

*en bricka*

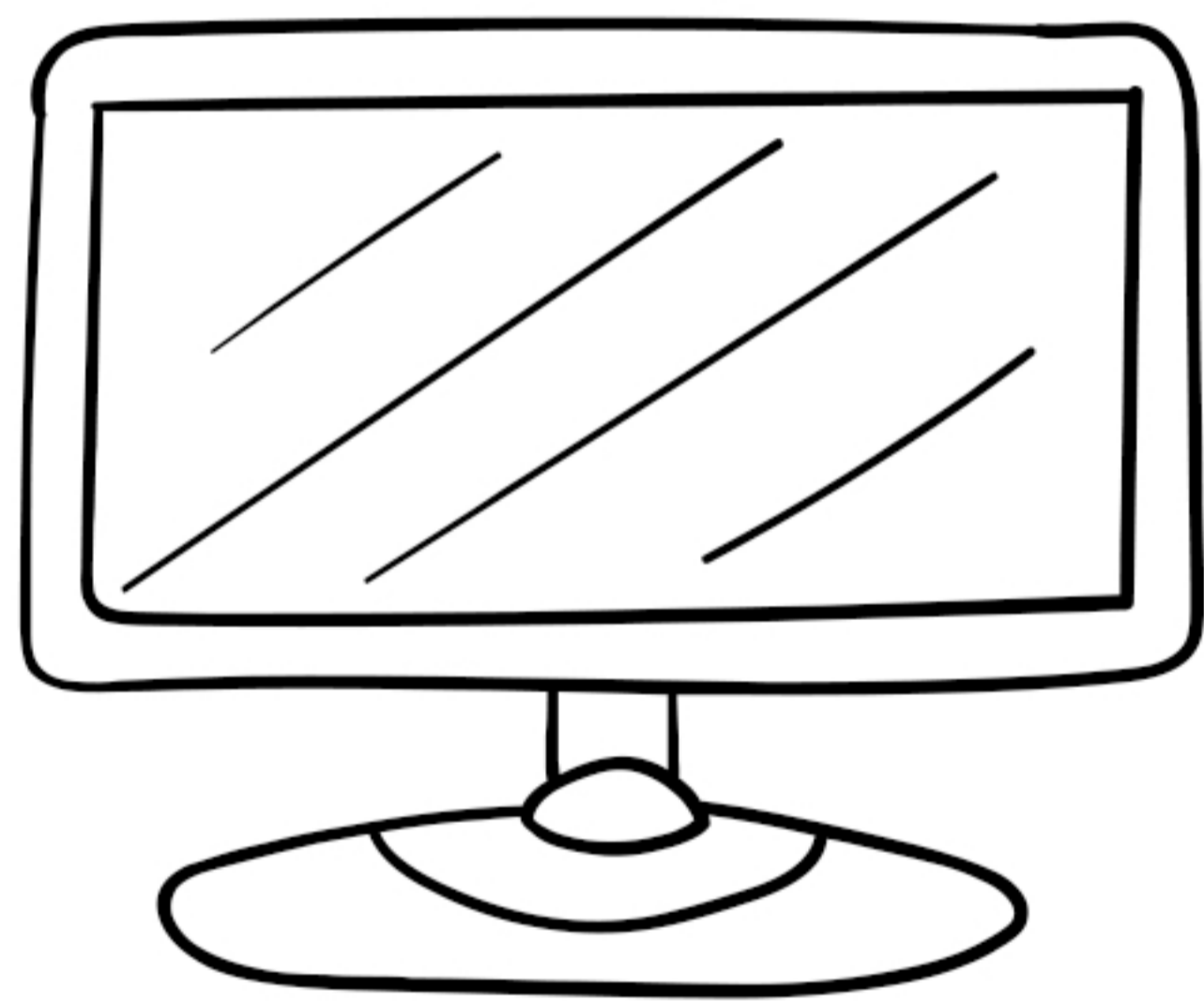

*en teve*

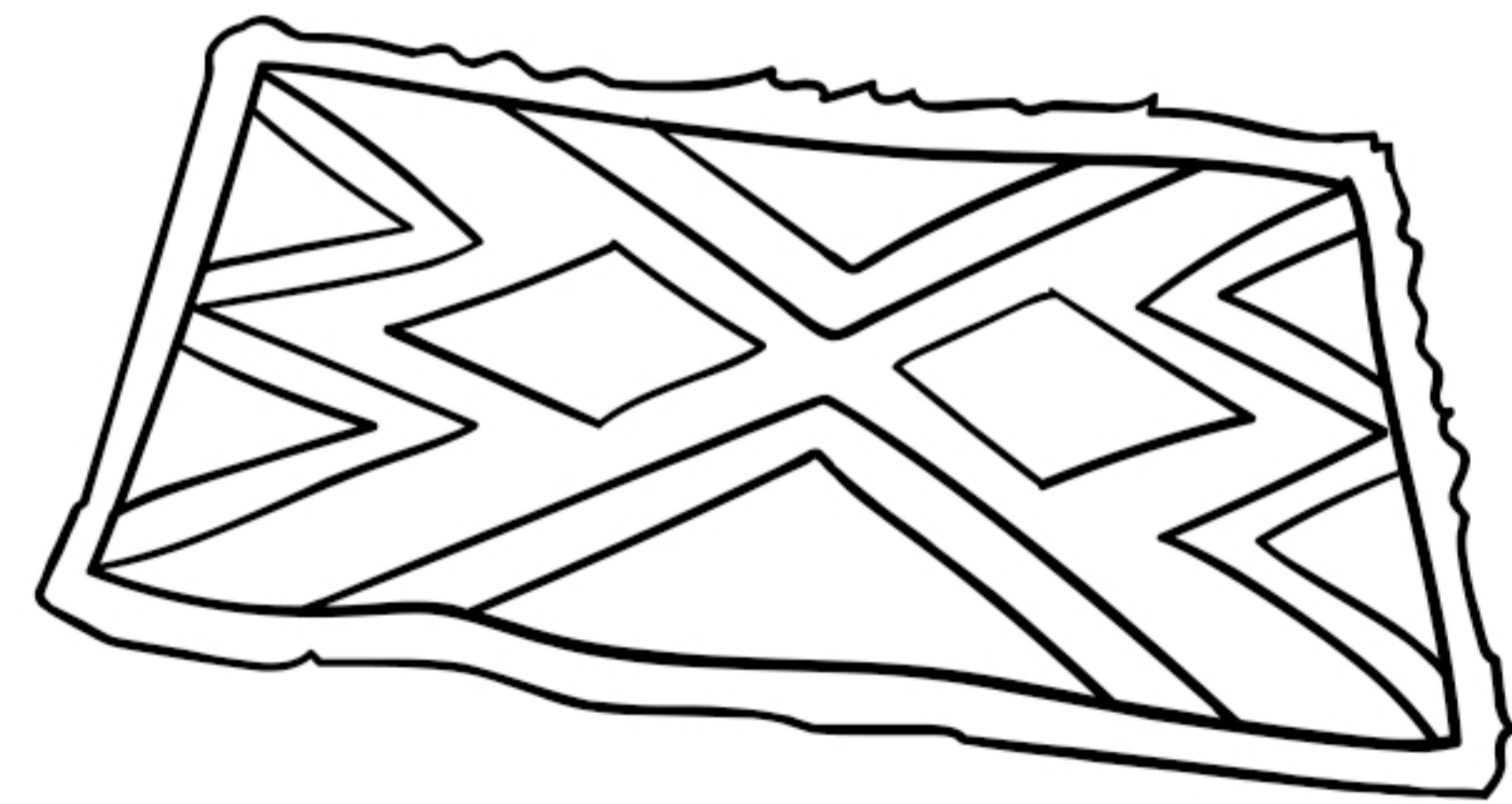

*en golvmatta*

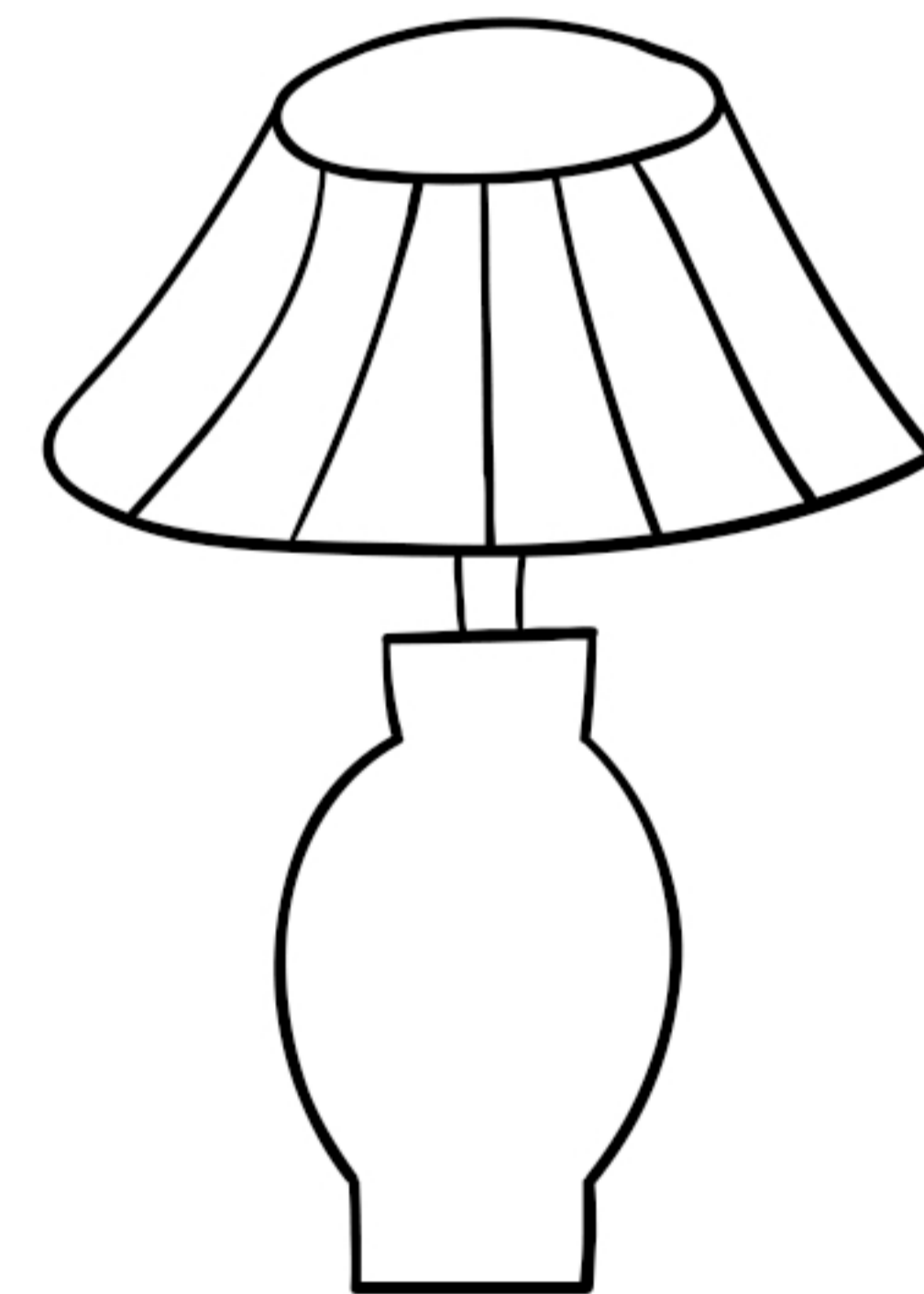

*en bordslampa*

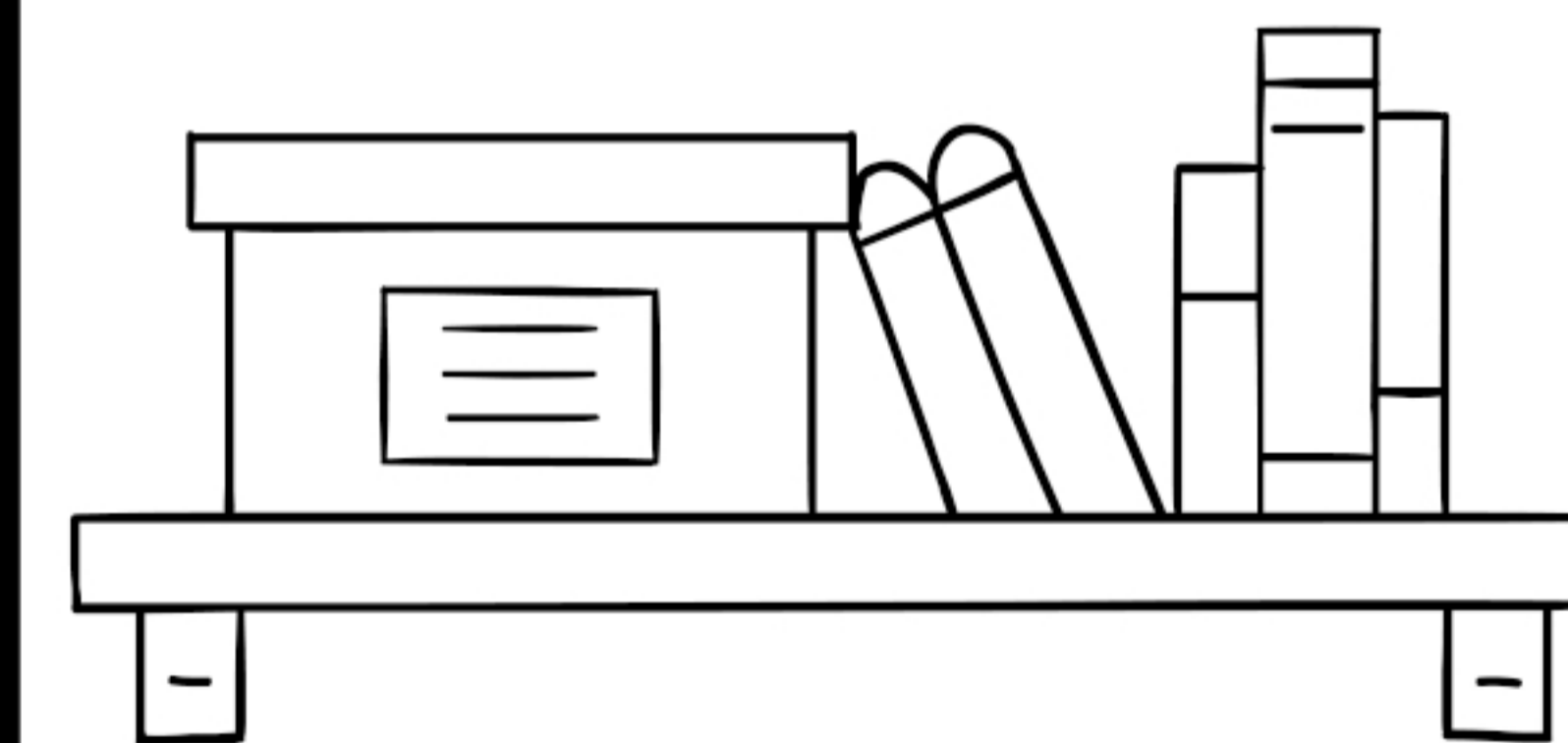

*en vägghylla*



*en telefon*

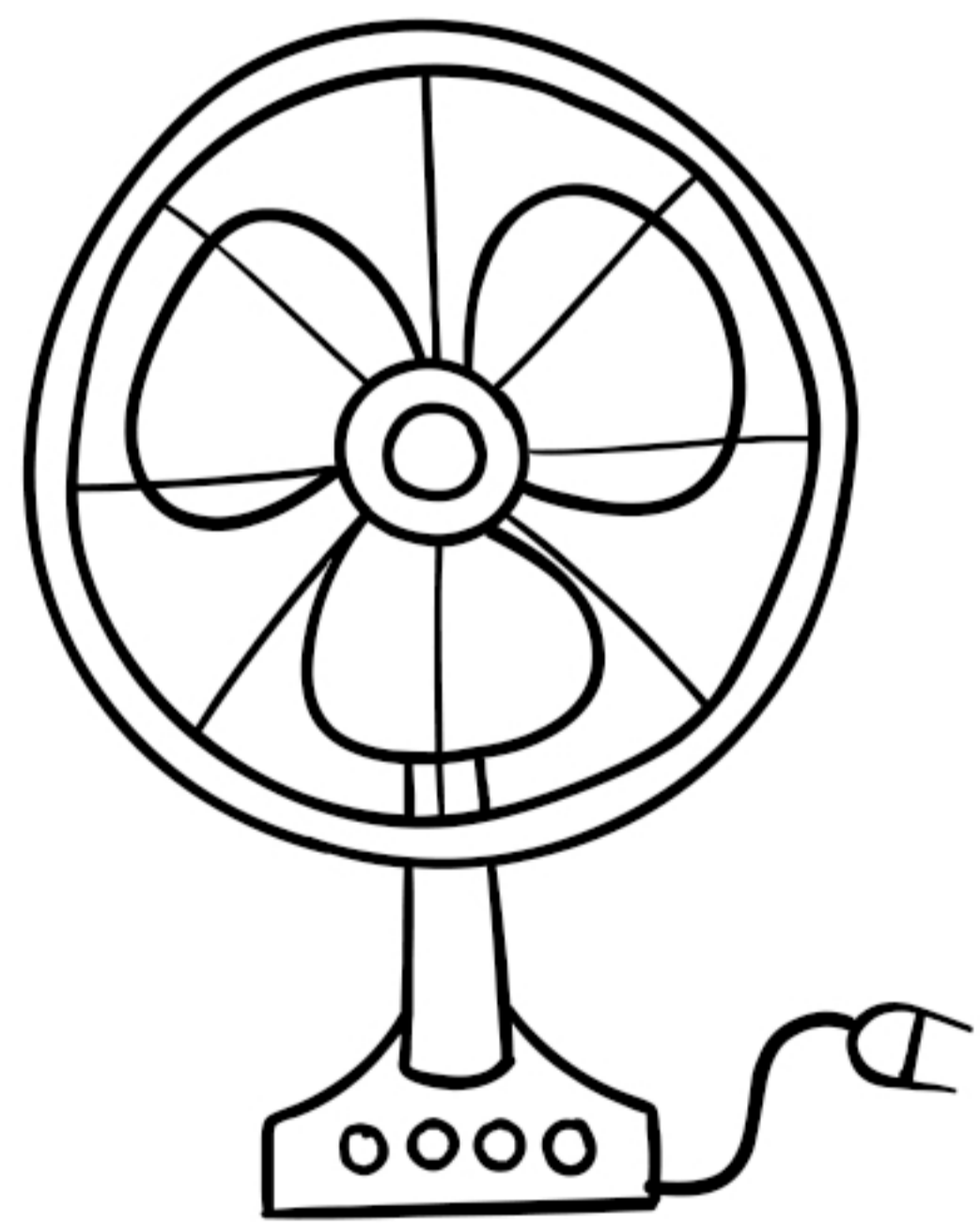

*en bordsfläkt*

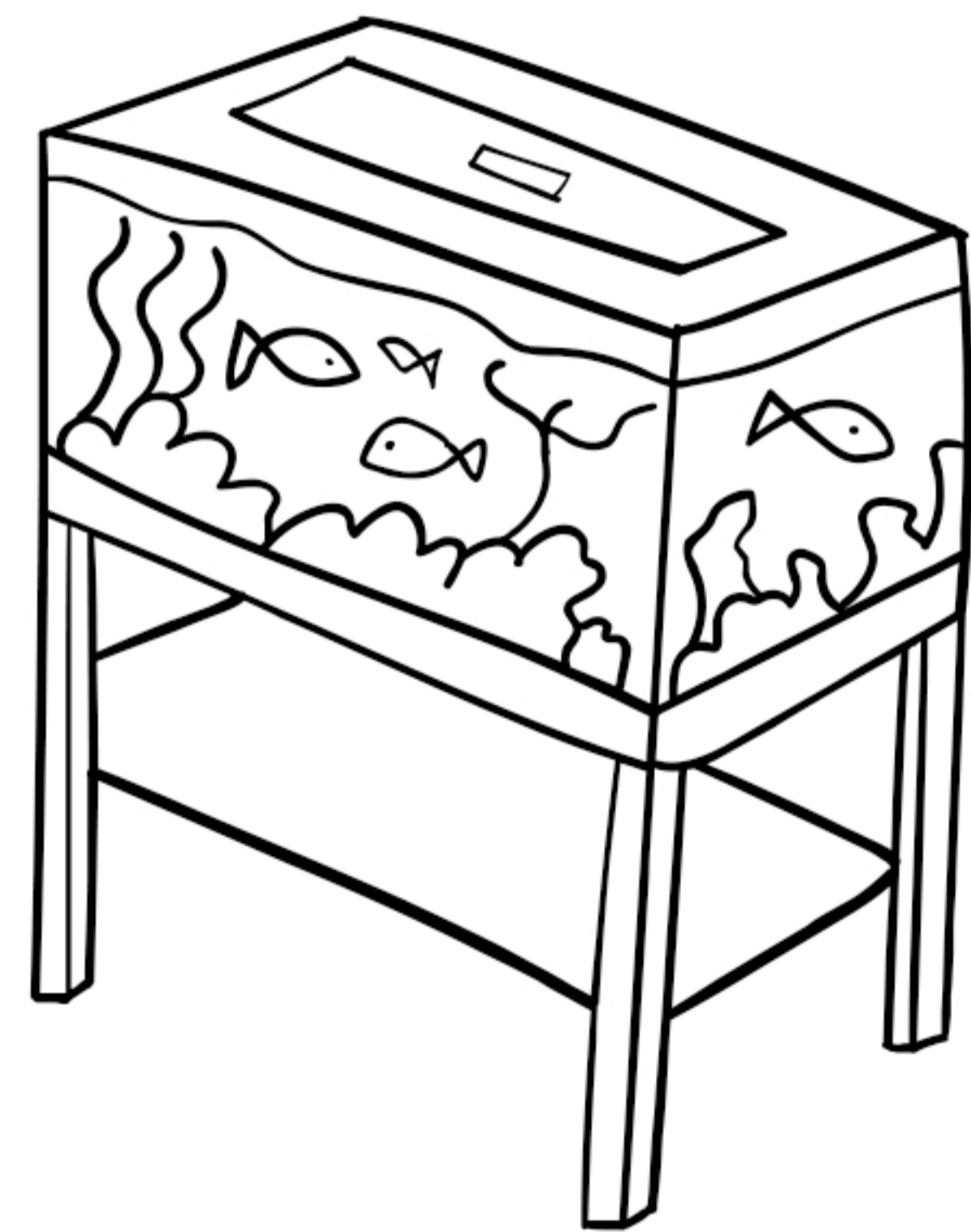

*ett akvarium*

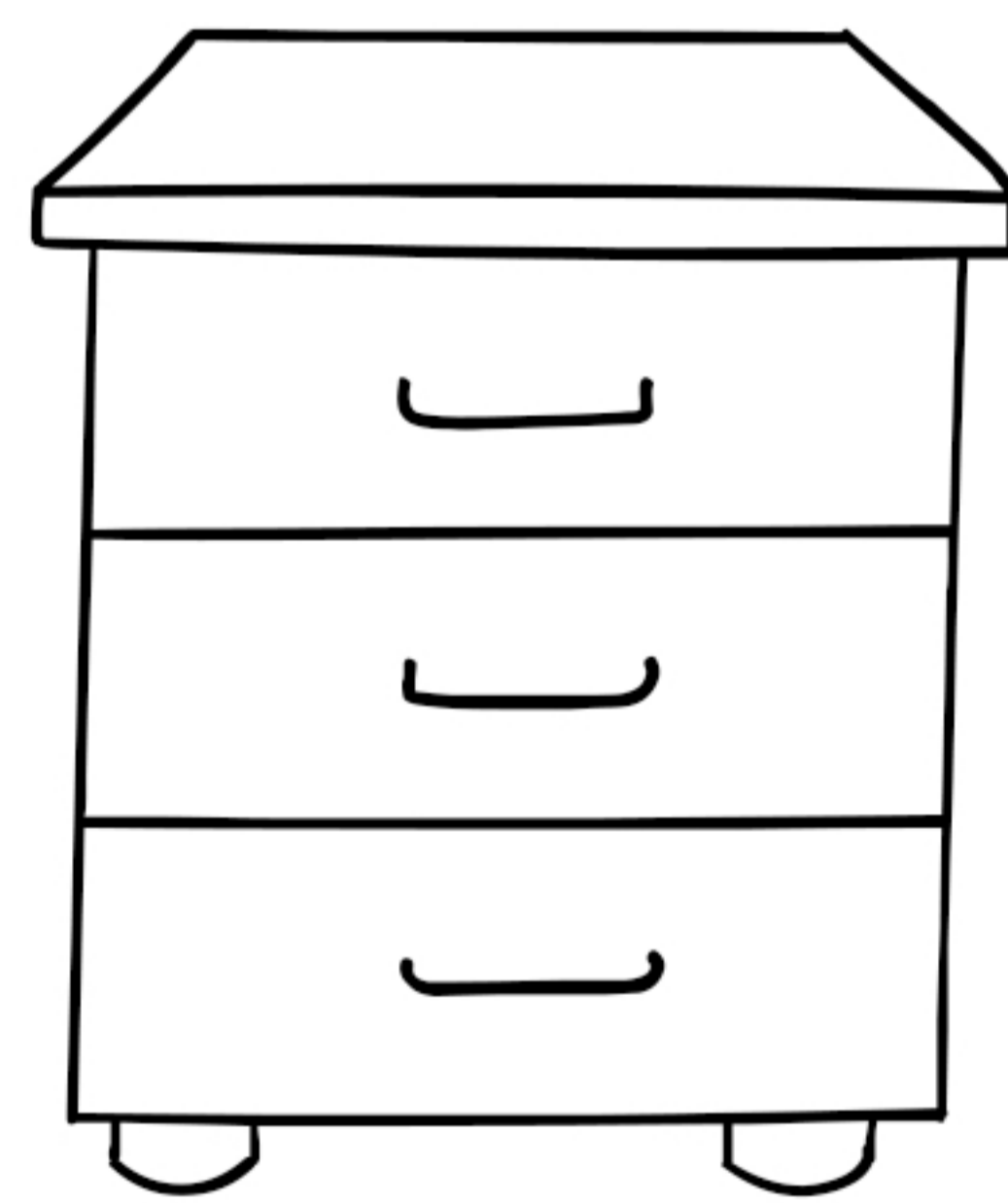

*en hurts*

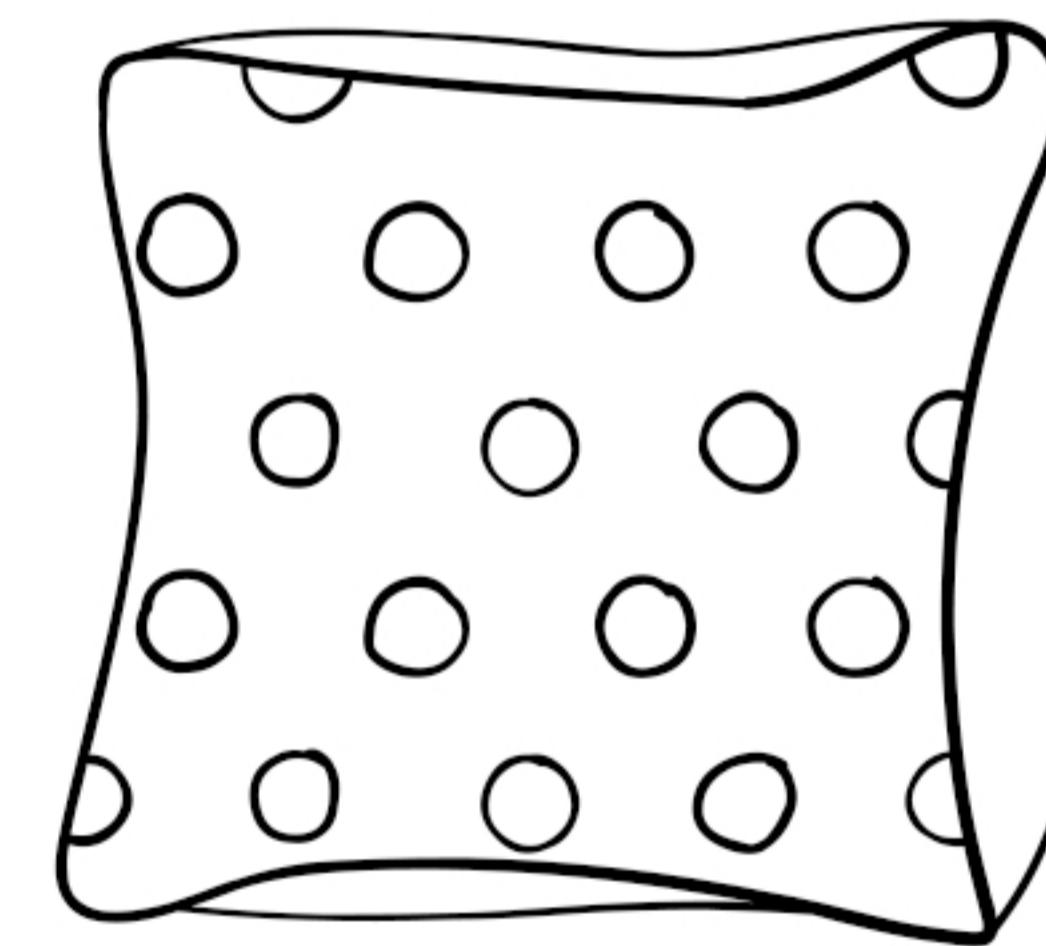

*en soffkudde*

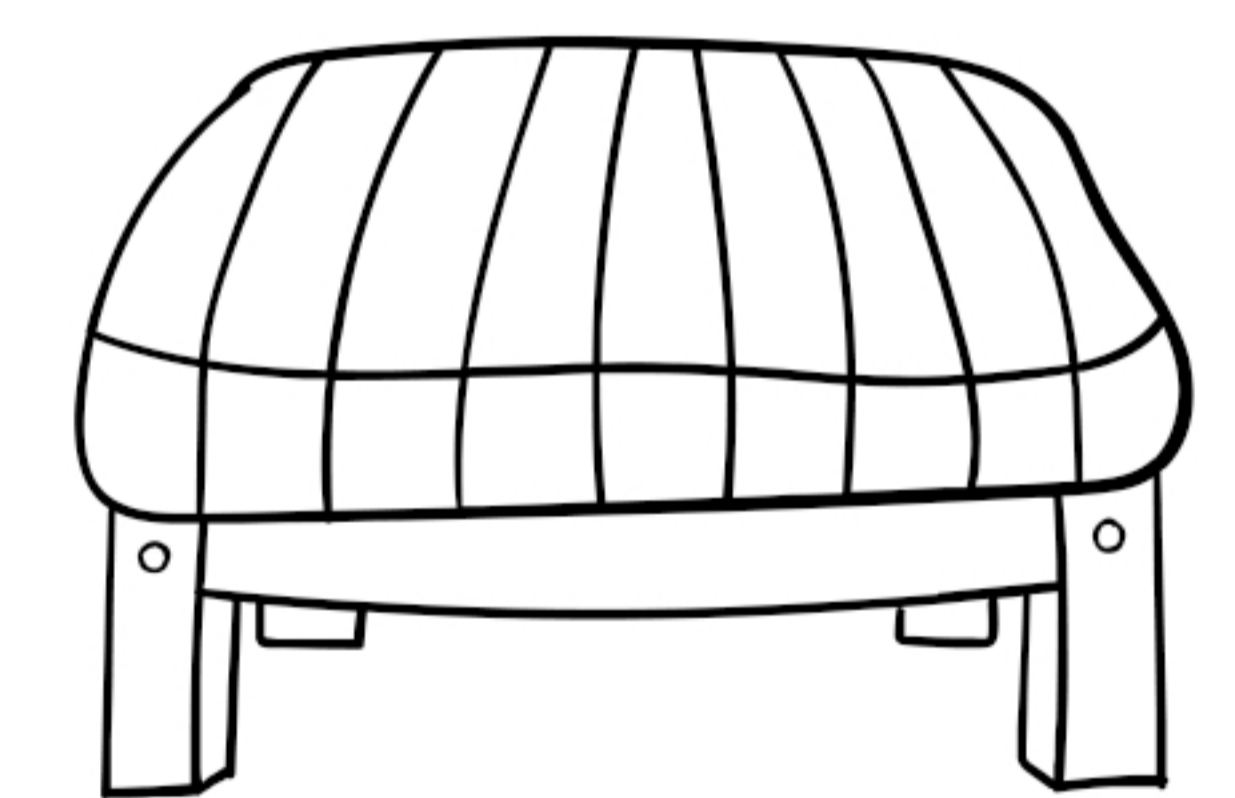

*en fotpall*